



**MCWP 3-20  
(Formerly MCWP 3-2)**

---

# **Aviation Operations**

---



**US Marine Corps**

---

**DISTRIBUTION STATEMENT A: Approved for public release; distribution is unlimited.**



**PCN 143 000019 00**

CD&I (C 116)

2 May 2016

ERRATUM

to

MCWP 3-2

AVIATION OPERATIONS

1. Change all instances of MCWP 3-2, *Aviation Operations*, to MCWP 3-20, *Aviation Operations*.

2. File this transmittal sheet in the front of this publication.

PCN 143 000019 80

## To Our Readers

**Changes:** Readers of this publication are encouraged to submit suggestions and changes that will improve it. Recommendations may be sent directly to Commanding General, Marine Corps Combat Development Command, Doctrine Division (C 42), 3300 Russell Road, Suite 318A, Quantico, VA 22134-5021 or by fax to 703-784-2917 (DSN 278-2917) or by E-mail to [morgannc@mccdc.usmc.mil](mailto:morgannc@mccdc.usmc.mil). Recommendations should include the following information:

- | Location of change
  - Publication number and title
  - Current page number
  - Paragraph number (if applicable)
  - Line number
  - Figure or table number (if applicable)
- | Nature of change
  - Add, delete
  - Proposed new text, preferably double-spaced and typewritten
- | Justification and/or source of change

**Additional copies:** A printed copy of this publication may be obtained from Marine Corps Logistics Base, Albany, GA 31704-5001, by following the instructions in MCBul 5600, *Marine Corps Doctrinal Publications Status*. An electronic copy may be obtained from the Doctrine Division, MCCDC, world wide web home page which is found at the following universal reference locator: <http://www.doctrine.usmc.mil>.

**Unless otherwise stated, whenever the masculine or feminine gender is used, both men and women are included.**

DEPARTMENT OF THE NAVY  
Headquarters United States Marine Corps  
Washington, D.C. 20380-1775

9 May 2000

FOREWORD

Aviation is an integral part of the naval expeditionary air-ground team—it extends the MAGTF's operational reach and flexibility and expands its warfighting power. Marine Corps Warfighting Publication (MCWP) 3-2, *Aviation Operations*, applies the warfighting philosophy in Marine Corps Doctrinal Publication (MCDP) 1, *Warfighting*, to Marine aviation operations. It is the link between higher order doctrine and the tactics, techniques, and procedures contained in other Marine aviation doctrinal publications. This publication establishes the doctrinal basis for the planning and execution of aviation operations and provides the philosophy for employment of Marine aviation in the prosecution of war and other operations in support of the Marine Corps' mission as the nation's expeditionary force in readiness.

This publication is intended primarily for commanders and staff officers who are responsible for the planning and execution of aviation operations. Nonetheless, it should be read by all Marines who are supported by or involved in the execution of aviation operations. It is also intended for other doctrine centers, joint and multinational staffs, professional military educational activities, and any other activity that requires an understanding of Marine aviation. It explains U.S. Marine Corps aviation capabilities and how the Marine air-ground task force (MAGTF) exploits these capabilities, both operationally and tactically. It does not discuss the specifics of unit-level tactics and procedures; e.g., air-to-air combat tactics, how to conduct a helicopterborne operation, or how to attack any particular target. Rather, this publication applies maneuver warfare concepts to Marine aviation operations, especially in aviation's role as an integrated combat arm of the MAGTF.

As with all Marine Corps doctrinal publications, this publication is authoritative in nature but requires judgment in application. It supersedes Fleet Marine Force Manual (FMFM) 5-1, *Organization and Function of Marine Aviation*.

Reviewed and approved this date.

BY DIRECTION OF THE COMMANDANT OF THE MARINE CORPS

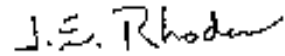
A handwritten signature in black ink, appearing to read "J. E. Rhodes". The signature is written in a cursive style with some capitalization.

J. E. RHODES  
Lieutenant General, U.S. Marine Corps  
Commanding General  
Marine Corps Combat Development Command

DISTRIBUTION: 143 000019 00

# Aviation Operations

## Table of Contents

	<b>Page</b>
<b>Chapter 1 The Role of Marine Aviation</b>	
1001 The Evolution of Marine Aviation: Adapting to Meet the Threat . . . . .	1-2
1002 Marine Aviation and the Levels of War . . . . .	1-5
<b>Chapter 2 The Missions, Functions, and Organization of Marine Aviation</b>	
2001 Functions of Marine Aviation. . . . .	2-1
2002 Marine Aviation Organization . . . . .	2-6
2003 Aviation Combat Element Task Organization . . . . .	2-14
<b>Chapter 3 The Role of Aviation in Combined-Arms Force Operations</b>	
3001 The Six Warfighting Functions. . . . .	3-1
3002 The Operational Environment . . . . .	3-2
3003 Organizational Adaptability . . . . .	3-3
3004 Marine Aviation and Maneuver Warfare . . . . .	3-4
3005 The ACE in Maneuver Warfare . . . . .	3-11
3006 Aviation in Offensive and Defensive Operations. . . . .	3-12
3007 Aviation in Security Operations . . . . .	3-13
3008 Aviation in Military Operations Other Than War . . . . .	3-14
<b>Chapter 4 Command and Control of Marine Aviation Operations</b>	
4001 Command Relationships . . . . .	4-1
4002 Aviation Combat Element Command and Support Relationships . . . . .	4-2
4003 Marine Aviation Command Relationships in a Joint Force . . . . .	4-4
4004 Other Command Authorities. . . . .	4-6
4005 The Marine Air Command and Control System. . . . .	4-7
<b>Chapter 5 Aviation Planning</b>	
5001 The Commander's Role in Planning. . . . .	5-1
5002 Staff Organization for Aviation Planning. . . . .	5-2
5003 Planning Cycles . . . . .	5-4
5004 Aviation Planning as an Element of MAGTF Planning . . . . .	5-5
5005 The Air Tasking Cycle . . . . .	5-7
<b>Chapter 6 Aviation Logistics</b>	
6001 Strategic Aviation Logistics and Aviation Ground Support. . . . .	6-1
6002 Operational Aviation Logistics and Aviation Ground Support . . . . .	6-1
6003 Tactical Aviation Logistics and Aviation Ground Support . . . . .	6-4

---

## Chapter 7 Marine Aviation in Navy, Joint, and Multinational Operations

7001	Navy Fleet Operational Support	7-1
7002	Joint Operations	7-1
7003	Multinational Operations	7-3

## Chapter 8 Emerging Concepts

8001	Operational Maneuver From the Sea	8-1
8002	Ship-to-Objective Maneuver	8-2
8003	Sustained Operations Ashore	8-3
8004	MPF 2010 and Beyond	8-3

## Appendices

A	Marine Aviation Organization	A-1
B	Glossary	B-1
C	References and Related Publications	C-1

## Chapter 1

# The Role of Marine Aviation

*“Today [aviation] is the dominant factor in war. It may not win a war by itself alone, but without it no major war can be won.”*<sup>1</sup>

—Adm Arthur Radford

Marine forces are general purpose forces and traditionally come “from the sea” with limited organic fire support and mobility assets. As such, Marine forces rely heavily on the fires, fire support, and mobility provided by Marine aviation. Marine aviation is an integral part of the Marine air-ground task force (MAGTF). It provides the MAGTF with a complete spectrum of operational capabilities and is a flexible instrument of the MAGTF’s combat power. The aviation combat element (ACE) is a powerful and versatile part of the MAGTF’s combined-arms team, complementing the MAGTF’s ground combat element (GCE) and combat service support element (CSSE), while functioning in consonance with the Marine Corps’ doctrinal philosophy of maneuver warfare.

Marine aviation provides the MAGTF with the operational flexibility it needs to accomplish its mission across the range of military operations. It extends the operational reach of the MAGTF and enables it to accomplish operational objectives designed to achieve strategic goals. The MAGTF uses the strategic and operational mobility afforded by the sea to employ its integrated air arm and to exert a powerful influence in most geographic areas of potential national concern. Since most ground- and ship-based fires have a limited range and ground-based mobility systems are limited by speed, range, and the terrain, the MAGTF’s ACE allows the MAGTF commander to conduct the deep fight. The ACE affords the MAGTF the ability to deliver fires, facilitate integrated command and control, enhance mobility and maneuver, provide force protection, sustain combat power, and collect intelligence.

Marine aviation’s expeditionary character sets it apart from all other aviation organizations. The ACE’s role is to project combat power, conduct air operations, and contribute to battlespace dominance in support of the MAGTF’s mission, and it organizes, trains, and equips for that role. Marine aviation can operate from amphibious platforms, forward operating bases (FOBs), forward expeditionary land bases, carriers (as an integral part of carrier air groups), or any combination thereof.

The MAGTF’s single-battle concept exploits the combined-arms nature of MAGTF operations. It allows the MAGTF commander to fight a single battle with an integrated, task-organized force of ground, aviation, and logistic forces. Based on this concept, operations performed by Marine aviation are rarely undertaken in isolation since its greatest value is in its integrated contribution to the MAGTF’s overall mission. It is designed to function most effectively as an integral part of the MAGTF and cannot be separated without a significant loss of capability. Marine aviation provides enhanced mobility and close fires for units in contact and augments ground and naval indirect fires. Marine aviation also gives a Marine expeditionary force (MEF), which would otherwise be a light infantry force, the operational reach of a corps-level force.

Marine aviation performs a variety of roles and tasks in support of national objectives. This can include fulfilling missions outside Marine aviation’s traditional MAGTF, naval expeditionary force, and joint force roles. Examples of Marine aviation being used in nontraditional roles include providing direct support to the President; providing aviation detachments for independent duty such as the Marines attached to the joint force air



component commander (JFACC) in Aviano, Italy, in support of operations in Bosnia; providing forces for counterdrug operations such as the ground-based air search radars teams deployed to support Operation Nimbus; and participating in disaster relief operations such as Homestead, Florida after it was struck by Hurricane Andrew.

Marine aviation provides the MAGTF with six specific functions: antiair warfare (AAW), offensive air support (OAS), assault support, air reconnaissance, electronic warfare (EW), and control of aircraft and missiles. These six functions are discussed in chapter 2.

## 1001. The Evolution of Marine Aviation: Adapting to Meet the Threat

The Marine Corps' contribution to national security is due largely to the ability of Marines to identify and adapt to the nation's strategic and tactical needs, often before those needs are widely recognized. As the Navy transitioned from sail to steam during the era of Alfred Thayer Mahan, the Marine Corps developed a concept for seizure and defense of advanced bases that would extend the fleet's reach worldwide. In 1912, the Marine Corps recognized the potential contribution of aviation to its emerging Advanced Base Force Concept. Less than a year later, Marine aviation participated in its first maneuvers off Guantanamo, Cuba. Marine pilots performed scouting and reconnaissance missions and dropped aerial bombs to support the fleet. This was the beginning of the evolution of Marine aviation that would eventually evolve into today's six functions of Marine aviation.

In January 1914, an all-Marine aviation force functioned in conjunction with Marine ground forces of the Advanced Base Brigade during annual fleet exercises. This was the first demonstration of what would become the Marine Corps' integrated combined-arms approach to warfare.

During World War I, Marine pilots received their first combat experience when they scored their first air-to-air victories, flew bombing missions, and conducted the first aerial resupply drop. These successfully integrated Marine air-ground operations proved that aviation could provide coordinated, direct support of Marine ground forces.

Marine operations in Nicaragua (1927–1933) produced the first practical air-ground integration and coordination techniques. Marine aviation was able to inflict heavy casualties on massed Sandinista forces by using bombs and machine guns. As a result of these attacks, Sandinista forces never massed again and were less of a threat to Marine forces. Marine aviation also conducted air reconnaissance, close air support (CAS), deep air support (DAS), aerial logistic support, and combat aerial evacuation against the Sandinistas. In 1932, Marine aviation experimented with the use of autogyros to support combat operations. However, at that stage of rotary-wing aircraft development, the rotary-wing aircraft was deemed ineffective because of its limited payload. But this experimentation set the stage for the helicopter's future development as a means of mobility for both troops and logistics.

Meanwhile, world events indicated the likelihood of a major naval war in the Pacific. Accordingly, the Marine Corps developed amphibious warfare techniques that laid the foundation for U.S. and Allied amphibious triumphs in World War II. These techniques were published in the *Tentative Landing Operations Manual* (TLOM) in July 1935. Concurrent with the development of the TLOM was the formal recognition and integration of Marine aviation as a part of the Marine Corps' operating forces. On December 8, 1933, the Fleet Marine Force (FMF) was created and aviation was formally incorporated into the FMF's organization. Marine aviation went on to play a key role in operations throughout World War II, particularly in providing CAS to amphibious forces.

During World War II, in the early months of 1942, the U.S. committed six carriers to the Pacific. By November, all but one of them had been sunk or put out of action. Marines on Guadalcanal

then focused on securing and improving a captured Japanese airstrip, later dubbed Henderson Field. From this “unsinkable” aircraft carrier, Marine, Navy, and Army Air Corps pilots launched numerous counterattacks against the enemy and provided a shield against Japanese forces attempting to dislodge our foothold on the island. Tactics used during these operations became the model for aviation support of ground and naval forces throughout the Pacific island-hopping campaign and, ultimately, led to the success of operations in the Pacific.

Following World War II, Marines focused on the helicopter’s potential utility. The first Marine Experimental Helicopter Squadron-1 was established at Quantico, Virginia. Its purpose was to conduct experiments, develop doctrine, and develop tactics for vertical envelopment using helicopters. The experiments produced tactics and doctrine, but the helicopter’s lift capacity in 1948 and 1949 was still limited to about 1,500 pounds. This experimentation resulted in the creation of the Shepherd Board and the establishment of minimum lift requirements for Marine troop transport helicopters.

As helicopter lift capabilities advanced so did the use of these aircraft. During the Korean War, helicopters were used extensively in combat operations. In July 1950, Marine Aircraft Group-33 (MAG-33) deployed with the Marine Corps’ First Provisional Brigade to Korea. One of MAG-33’s squadrons, Marine Observation Squadron-6 (Fixed-Wing) (VMO-6), was composed of fixed-wing observation aircraft and four helicopters. VMO-6 used its helicopters primarily for the rescue of downed pilots, and it developed tactics (e.g., the use of armed escorts) that are still used today during pilot rescue operations. In September 1951, the Marine Helicopter Transport Squadron 161 conducted the first Marine Corps vertical envelopment in combat, which was based on the vertical envelopment doctrine and tactics developed at Quantico, Virginia during the 1940s.

Marine aviation’s tradition of providing effective CAS with its fixed-wing aircraft was also significantly enhanced during the Korean War as it flew

jets into combat for the first time on December 10, 1950. During March and April of 1951, one squadron maintained 10-minute standby alerts, with four pilots in the cockpits of their aircraft. This allowed the unit to respond to urgent calls for CAS from the tactical air command center (TACC) via the direct air support center (DASC). As a result, a more responsive CAS system was established that allowed the use of airborne, alert aircrews that were briefed as they approached the target.

Radar systems that were effective at night were also installed on some aircraft, such as the F-7F Tigercat, during the Korean War. Radar capabilities allowed commanders to designate some squadrons to fly only at night, thereby enhancing the squadron’s effectiveness while minimizing its vulnerability. These night-flying pilots were normally under the control of a forward air controller (FAC), an employment method that was later used extensively in the Vietnam War.

Another advancement during the Korean War was the establishment of Marine Photographic Squadron 1 on February 25, 1952. This squadron flew F2H-2P Banshees, which were specially modified with a long nose to accommodate several reconnaissance cameras. These were the first Marine aircraft specifically dedicated to reconnaissance. The aerial photographs provided by this unit were invaluable aids to intelligence and targeting.

During the post-Korean and pre-Vietnam period, the Marine Corps continued to develop doctrine and tactics for the employment of both fixed-wing and rotary-wing aircraft. In 1962, Marine Medium Helicopter Squadron 362 was deployed to South Vietnam to provide mobility support to the South Vietnamese army, which was conducting operations south of Saigon. These operations provided invaluable experience to the Marine Corps in the conduct of helicopterborne operations. On the basis of these experiences, helicopters were fitted with door-mounted, M-60 machine guns, which enabled helicopters to return fire while landing in hot landing zones. The need for an aerial escort to protect the helicopters and prepare a landing zone was also recognized. Initially, this

role was filled by slow-flying, fixed-wing fighter aircraft. Later, the UH-1B Huey helicopter gunship was developed to meet this need and was fielded in Vietnam in 1963. The need for greater firepower and for armor to protect critical areas of the helicopter were also identified. The UH-1B provided escort and fire support for helicopter-borne operations until the AH-1G Cobra was fielded in 1967.

Command and control of aircraft improved during the Vietnam War. Radar information was manually plotted during the first several years of the war, then a computer-based aircraft command and control system (Marine Corp tactical data system [MTDS]) was deployed to Vietnam. It provided the first automated aircraft command and control system for Marine aviation that was compatible with the Navy's command and control system.

During the Vietnam War, Marine aviation developed the foundations for the doctrine, tactics, and equipment used today. At the conclusion of the Vietnam War, Marine aviation had developed and demonstrated the capability to conduct OAS, assault support, air reconnaissance, EW (including the ability to counter modern air defenses), control of aircraft and missiles, and AAW. Rotary-wing aviation concentrated on improvements in lift capability, mobility, and helicopter fire support techniques. Fixed-wing aviation focused on improvements in turbojet engine technology and aircraft design. These improvements led to a new generation of aircraft that were faster and more maneuverable, and which could carry a wide variety of new and improved munitions. One of the most significant aspects of this new technology, which was to have a profound impact on both aircraft design and AAW doctrine, was the introduction of the guided missile. Unlike the Korean War, when air-to-air combat and air defense was fought with essentially the same weapons and tactics as was used in World War II, the Vietnam air war was fought with the guided missile. By the end of the war, missile technology and employment dominated both friendly and enemy AAW doctrine and accounted for a majority of our air-to-air combat victories.

Full-scale Marine participation in Vietnam began in 1965. The doctrine and tactics for helicopter-borne operations, which were refined while supporting the South Vietnamese army, provided a sound basis on which Marines continued to build. The UH-1B gunships that deployed to Vietnam in 1963 were replaced by AH-1G attack helicopters in 1967 and two-engined AH-1J Sea Cobra in 1969. The CH-53A Sea Stallion and the CH-46 Sea Knight were introduced in 1966 and provided a significant improvement to lift capacity and the ability to conduct helicopterborne assaults and re-supply operations.

In July 1965, Marine Composite Reconnaissance Squadron 1 (Fixed-Wing) arrived in Vietnam. This unit was equipped with the EF-10B Sky Knight, an electronic countermeasures platform. The EF-10B was flown extensively during the next 2 years and provided effective protection against Soviet-built and -supplied surface-to-air missiles (SAMs). Late in 1966, a newer, more capable aircraft (the EA-6A Intruder) replaced the EF-10B. Also in 1966, the Marine Corps introduced the RF-4B Phantom, which was a reconnaissance version of the F4 Phantom. The RF-4B provided a significant jump in combat capability. It replaced the RF-8A Crusader, initially deployed to Vietnam, and was the first Marine aircraft capable of acquiring imagery at night.

Through the late seventies, the eighties, and into the nineties, as the U.S. modernized its forces, the Marine Corps continued its legacy of innovation. From vertical/short takeoff and landing (V/STOL) aircraft to unmanned aerial vehicles (UAVs) to precision-guided munitions, the Marine Corps continued to be a leader in adapting new technology to warfighting. The Marine Corps developed a warfighting concept that emphasized smaller expeditionary forces that used speed, tempo, and seamless air-ground integration as force multipliers, known as maneuver warfare. This concept proved highly successful against Iraqi forces during the Persian Gulf War.

This concept resulted in a Marine air-ground team, referred to as a MAGTF, that has had a profound impact on the nation's ability to respond to

crises and conflicts. The MAGTF is the Marine Corps' principal organization for all military operations. It is composed of forces task-organized under a single commander to accomplish a specific mission. These forces are functionally grouped into four core elements: a command element (CE), an aviation combat element (ACE), a ground combat element (GCE), and a combat service support element (CSSE). The MAGTF's flexible organizational structure allows for other Service or foreign military force(s) to be assigned or attached to it. The four core elements are not formal commands. The number, size, and type of forces that comprise each element is mission dependent. The ACE is task-organized to provide the specific capabilities required of Marine aviation to support the MAGTF. The ACE is not subordinate to the GCE; it is a co-equal combat arm of the MAGTF that provides the mobility, flexibility, coordination, and firepower required to successfully employ maneuver warfare.

An important part of the development of Marine aviation has been the concurrent development of the role of Marine aviation reserve forces. Since 1935, the Reserves have not only played an important role in conflicts but have often led the way in the development of aviation concepts and doctrine. The Reserves are organized, equipped, and trained as an integral part of Marine aviation. Marine aviation reserve units can provide the full spectrum of aviation support functions and individual aviation units to reinforce an ACE.

The end of the Cold War brought with it a period of crises and conflicts of increasing number, frequency, and variety, and the Marine Corps provides the National Command Authorities with the capability to rapidly respond to crises wherever they may occur. Crisis response requires a full spectrum of military capabilities, including forcible entry and military operations other than war (MOOTW). Defense of national interests requires an expeditionary crisis response force that is specifically organized, trained, and equipped to quickly project military power overseas. This rapid-response, general-purpose force must maintain itself in a continuous state of readiness and it must be prepared to adapt to a broad range of operating

environments on short notice. It must possess a strategic mobility that allows it projection wherever it is required. By virtue of its naval character, expeditionary nature, and combined-arms organization, the MAGTF, with its ACE, is capable of responding to these requirements.

The ever-changing world security environment requires that Marine aviation continually anticipate and adapt to new challenges. Employing new technology with existing doctrine will not always provide the required operational capabilities. Constant refinement of aviation doctrine and a continuous exploration of innovative ideas are necessary. This proactive approach has been the hallmark of Marine aviation.

## **1002. Marine Aviation and the Levels of War**

War is fought at three levels: strategic, operational, and tactical. Although Marine aviation is designed primarily as a tactical instrument, it can make significant contributions at all three levels.

### **a. The Strategic Level of War**

In contrast to tactics, which is the art of winning engagements and battles, military strategy is the art of winning wars. Strategy is implemented by combatant commanders and is always joint in nature. The MAGTF makes a strategic contribution when it is used as an element of national power to accomplish national policy objectives. Since Marine aviation is bonded to the MAGTF by mission, organization, and employment, its strategic contributions are normally encompassed within the MAGTF support it provides. For example, a sea-based MAGTF strategically positioned near a world "hot spot" may be the ideal force to indicate U.S. political concern or resolve on a volatile issue. If the strategic objective is to show a U.S. presence in the area, Marine aviation operations become a visible show of force without physically landing U.S. troops ashore. In this case, Marine aviation's contribution to the strategic objective would be dominant, but it is still performed in

support of the MAGTF's mission and not considered an independent action.

Marine aviation's naval expeditionary character makes it a force of choice whenever political considerations preclude a deliberate build up of forces and their supporting infrastructure ashore. Marine aviation also has the collateral mission of participating as an integral component of naval aviation as directed by fleet commanders. Marine aviation has, in some cases, been tasked to conduct operations while not part of a MAGTF, this is the exception rather than the rule. For example, Marine aviation has been used against targets of strategic value in an air strike launched from a Navy aircraft carrier as part of a joint force. Another example is the use of Marine aviation assets in support of North Atlantic Treaty Organization (NATO) forces in Bosnia and Kosovo. Both examples are exceptions to the normal doctrinal employment of Marine aviation. Marine aviation is, first and foremost, an integral component of the MAGTF.

## **b. The Operational Level of War**

The operational level of war links tactical results to strategic aims. The operational use of aviation relates to campaigning. Aviation at the operational level of war shapes events by deciding when, where, and under what conditions to engage the enemy in battle. At the operational level, the MAGTF commander uses aviation against targets of operational significance. These targets consist of enemy capabilities or resources whose destruction or neutralization are important to the prosecution of the campaign.

Marine aviation participates at the tactical and operational levels as part of a MAGTF. Doctrinally, this is Marine aviation's primary mission: to participate as the air component of the MAGTF in the seizure of advanced naval bases and to conduct land operations as may be essential for the prosecution of a naval operation. The capabilities provided by aviation allow the MAGTF commander to generate operational capability quickly at or near the location of any conflict. Aviation provides the resiliency and flexibility required to

respond appropriately to developing situations by either expanding or reducing U.S. military presence as directed by the theater commander.

In most operations, the MAGTF serves as part of a joint task force (JTF) under the command of a joint force commander (JFC). Joint Publication (JP) 0-2, *Unified Action Armed Forces (UNAAF)*, establishes the doctrine, principles, and policies of a joint force. Marine aviation supports joint force operations as an integral part of the MAGTF. This ensures that the MAGTF retains its unique capability to generate combined-arms combat power. The MAGTF commander will retain operational control (OPCON) of the ACE during all joint operations. Any sorties in excess of the MAGTF's direct support requirements are normally made available to the JFC. The JFC uses the MAGTF's excess sorties to support other components of the joint force in pursuit of overall campaign objectives. The MAGTF commander also makes sorties available to the JFACC for air defense, long-range interdiction, and long-range reconnaissance. See JP 3-56.1, *Command and Control for Joint Air Operations*, and JP 3-09, *Doctrine for Joint Fire Support* for detailed information on command and control of joint air and fire support operations.

The capabilities of aviation, including its speed, range, and mobility, easily translate to the operational level of war. Because Marine aviation has significant range, the MAGTF commander can use air interdiction to strike deep within the enemy's rear areas and air reconnaissance to gather needed information. Air defense sorties can protect the MAGTF as well as contribute to the protection of a joint force, all of which are significant contributions to the JFC's operational goals.

The implications of an action taken at one level of war seldom remain confined to that level. Actions taken at the operational level may influence other actions across all three levels of conflict. This overlap between the operational and tactical levels of war must be understood if we are to maximize opportunities for success.

### c. The Tactical Level of War

Operational goals give purpose to tactical actions. In turn, tactical actions may influence operational goals. The tactical-operational relationship is important when deciding the best way to employ aviation because aviation is uniquely capable of having an immediate impact at both the tactical and operational levels of war.

Success at the operational level can promote success at the tactical level. The employment of aviation at the operational level during Operation Desert Storm served to disrupt Iraqi command and control, degrade defenses, and demoralize troops. The success of Operation Desert Storm's operational goals contributed to tactical successes during the ground operations phase.

Success at the tactical level can foster success at the operational level; however, success at the tactical level can prove indecisive unless linked to operational goals. Aviation can play a significant role in turning a tactical success into an operational decision. This is illustrated by Allied efforts in the South Pacific during World War II.

Beginning in the Solomon Islands with Guadalcanal in 1942, naval aviation played a major role in the destruction of the best elements of the Japanese naval air forces. Defending their major base at Rabaul on the island of New Britain against Allied air attacks, the Japanese committed and lost all of their fully-trained naval air units, including those that survived the Battle of Midway. They also committed and lost a portion of their best-trained army air units. Subsequently, the Japanese never fully recovered from these losses.

The advantage gained by defeating a large portion of Japan's best-trained combat pilots in Guadalcanal and New Britain would prove vital to continuing Allied operations. The onslaught against Rabaul by Allied aircraft, over half of which were flown by Marine aviators, prevented Japanese aircraft from prohibitively interfering with American landings in the Solomons area, most notably at Cape Gloucester. The continued pressure of naval aviation against Rabaul eventually caused the

withdrawal of Japanese aircraft from the island fortress. The combined effect of the tactical successes in the Solomons degraded Japan's combat power and the Allies were able to bypass Rabaul, an operational maneuver that isolated about 100,000 Japanese.

Operation Overlord, the great amphibious landing in Normandy during World War II, is an example of how the operational use of aviation determined the conditions of engagement. The operational role of aviation in Operation Overlord was to ensure that the enemy forces attacking the beachhead did not increase at a more rapid rate than the Allied forces defending it and extending it. Three air attacks were conducted on targets hundreds of miles from the contested ground and were timed to disrupt Nazi attempts to reinforce units engaged in Normandy. Allied aviation successfully delayed the movement of German reserves that could have countered the Allied landing. Operationally, the German army remained paralyzed. Field Marshal Erwin Rommel reported in his June 10, 1944 dispatch that practically all traffic on roads, tracks, and in open country was pinned down by powerful fighter-bomber and bomber formations. As a result, the movement of German troops on the battlefield was almost completely paralyzed, while the Allies maneuvered freely.

The Gulf War contains recent examples of tactical events that impacted the operational level of war. During the first 6 months of Operation Desert Shield, 1st Marine Division spent a great deal of time scrutinizing the 8-year Iran-Iraq war. Planners learned that Iraqi artillery was very effective in trapping Iranian soldiers in confined areas called firesacks, where thousands of Iranians perished. The firesack, like our engagement area, is an area along an enemy avenue of approach intended to contain and destroy an enemy force with the massed fires of all available weapons. Studies of the two obstacle belts in Kuwait and the positioning of more than 1,200 Iraqi artillery pieces behind those obstacle belts indicated that when the Marines attacked, the Iraqis meant to trap them in at least two firesacks. Marine planners also recognized that their available aviation ordnance was not sufficient to destroy the Iraqi

artillery during the first phase of Operation Desert Storm. Therefore, planners designed a series of combined-arms raids to defeat the Iraqis' plan before they even attacked into Kuwait.

Operation Desert Storm kicked off on January 17, 1991. On January 19th, Marine aircraft conducted their first raid. Coalition forces were going to move an artillery battery, escorted by a light armored infantry company, close to the Kuwaiti border at night. A Marine EA-6B Prowler EW aircraft was to be stationed inside Saudi Arabian airspace to jam the Iraqis' radars until after the entire artillery battery had fired on a designated target. As the artillery battery started to withdraw, EA-6B aircraft would stop jamming just long enough for the Iraqis to detect the battery's movement before it began jamming again. The intent was to cause the Iraqi artillery to respond to Marine indirect fires. Once the Iraqis began firing, a Marine forward air controller (airborne) (FAC[A]) in a Marine F/A-18 Hornet detected the Iraqis' muzzle flashes and directed a flight of Marine F/A-18s to roll in on the firing Iraqi artillery.

The plan's goal was to convince Iraqi artillerymen not to man their artillery pieces for fear that every time they did so Marine aircraft would attack them. By the third week in February, after a series of these raids, the plan's goal was achieved. UAVs showed Iraqi artillerymen abandoning their howitzers as Marine aircraft began attacking their positions.

These successful raids at the tactical level had dramatic effect at the operational level. The fear of an attack from aviation assets made Iraqi artillery ineffective in the final phase of the war. This undoubtedly saved many lives and contributed to the strategic success of Operation Desert Storm.

Another Gulf War example of the impact of aviation at the operational level took place the night of January 29, 1991. During the night, several battalion-sized Iraqi units attacked Coalition forces in and around the border town of Khafji. The Iraqis surprised the Coalition forces and occupied the town. However, Arab ground forces belonging to the Coalition quickly counterattacked and, with the aid of CAS, regained possession of Khafji 2 days later. This purely tactical event is, only part of the story. The night before the recapture of Khafji, farther to the north, Saddam Hussein amassed more than two divisions of armor and mechanized infantry to join the fight for the town. Because of technological advancements, the night no longer provided its traditional sanctuary. Within minutes, the joint surveillance, and target attack radar system (JSTARS) discovered the Iraqi force and began employing Coalition aircraft against it. Using precision-guided weapons, air strikes continued throughout the night and devastated the two divisions. They never reached their desired objective, and by morning, they were retreating in total disarray.

The Battle of Khafji was important for the Coalition. Tactically, the Pan-Arab forces defeated the Iraqis in a pitched battle, launching a difficult night counterattack against enemy armor. Operationally, the destruction inflicted on two Iraqi divisions by Coalition aircraft convinced the Iraqis that any force that left its defenses to conduct a mobile operation would be decimated. During the remainder of the war, the Iraqis never again attempted an offensive operation. The operational result was a paralyzed military force that was unable to interfere with Coalition maneuver operations.

## Chapter 2

# The Missions, Functions, and Organization of Marine Aviation

*“Marine aviation units are an integral element of an air-ground combat system. They are not merely joined at the top when the time comes to fight. They are fully integrated from top to bottom, and they train that way full-time.”<sup>2</sup>*

—Gen Carl E. Mundy

Marine Corps aviation is organized, trained, and equipped to provide a task-organized ACE for any size MAGTF. The ACE is not a formal command. The term “ACE” categorizes the functionality of specific forces within the MAGTF. For any MAGTF, the ACE is composed of task-organized Marine aviation forces under a single commander. The ACE commander is the MAGTF commander’s principal advisor and subject matter expert on all aviation activities.

The ACE must be prepared to support MAGTF expeditionary operations from both sea-based and shore-based facilities. The ACE’s primary mission is to support the MAGTF during all phases of expeditionary operations as well as during sustained operations ashore.

### 2001. Functions of Marine Aviation

The tasks of Marine aviation fall into six functional areas (see fig. 2-1 on page 2-2): offensive air support, anti-air warfare, assault support, air reconnaissance, electronic warfare, and control of aircraft and missiles. Planners initially consider the functional area, not the means (i.e., particular weapons systems), when analyzing the fundamental requirements of accomplishing any given objective.

#### a. Offensive Air Support

OAS involves air operations that are conducted against enemy installations, facilities, and person-

nel in order to directly assist in the attainment of MAGTF objectives by destroying enemy resources or isolating enemy military forces. Its primary support of the warfighting functions is to provide fires and force protection through CAS and DAS. The application of OAS can sometimes be decisive by directly or indirectly affecting an enemy’s center of gravity. OAS allows the commander to influence the battle by projecting firepower to shape events in time and space. It also allows the commander to shape the battlespace by delaying enemy reinforcements, degrading critical enemy functions, and manipulating enemy perceptions, which ultimately results in protection of the force. Marine fighter/attack squadrons (VMFAs), Marine fighter attack (all weather) squadrons (VMFA[AW]s), Marine attack squadrons (VMAs), Marine light/attack helicopter squadrons (HMLAs), and Marine unmanned aerial vehicle squadrons (VMU) provide OAS during OAS missions. OAS includes two categories: CAS and DAS.

**(1) CAS.** CAS is an air action performed by fixed-wing and rotary-wing aircraft against hostile targets that are in close proximity to friendly forces. CAS requires detailed integration of each air mission with the fire and movement of friendly forces.

**(2) DAS.** DAS is an air action against enemy targets at such a distance from friendly forces that detailed integration of each mission with fire and movement of friendly forces is not required. Close coordination of the fire and maneuver of friendly forces is a qualifying factor for a DAS



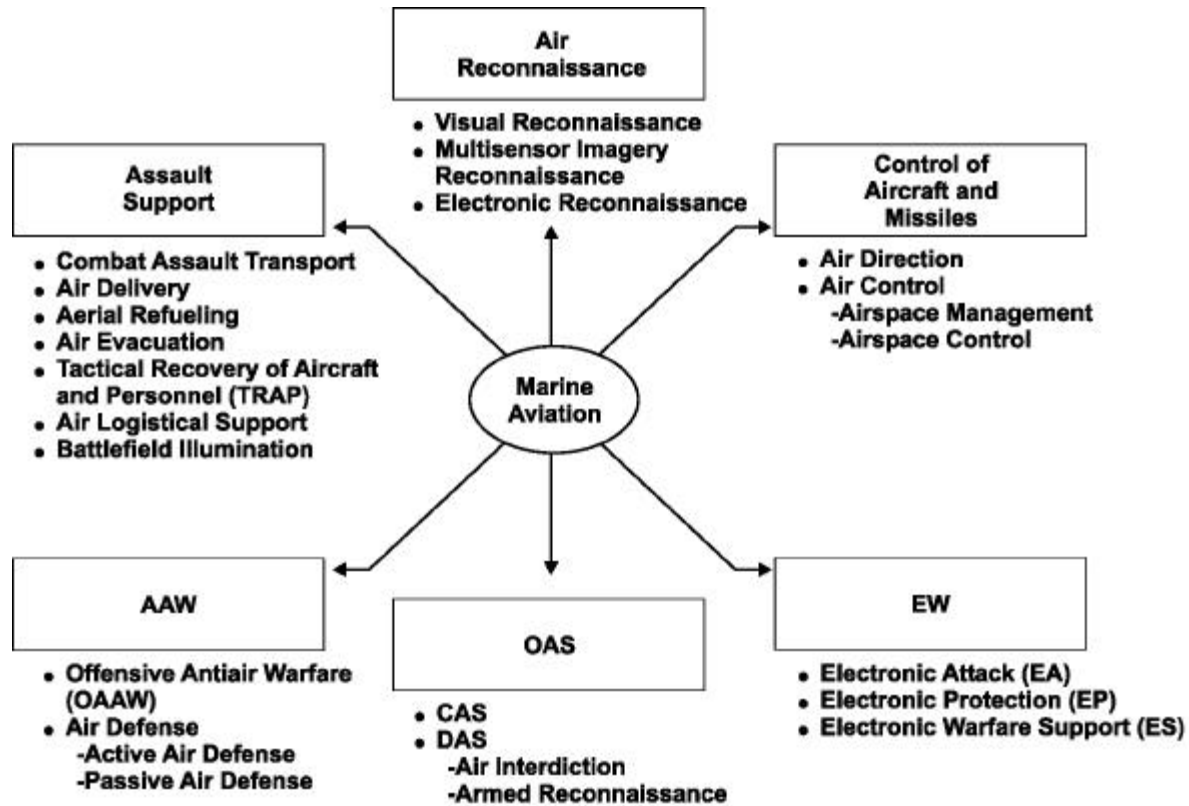

Figure 2-1. The Six Functions of Marine Aviation.

mission. DAS missions are flown on either side of the fire support coordination line. These missions include air interdiction and armed reconnaissance.

**(a) Air Interdiction Operations.** An air interdiction operation destroys, neutralizes, or delays the enemy's military potential before it can be brought to bear effectively against friendly forces. This type of operation is a response to a known target that is briefed in advance.

**(b) Armed Reconnaissance Missions.** An armed reconnaissance mission finds and attacks targets of opportunity (i.e., enemy materiel, personnel, facilities) in assigned areas. This type of operation is a response to targets that are not known or briefed in advance.

## b. Antiair Warfare

AAW is the actions used to destroy or reduce the enemy air and missile threat to an acceptable lev-

el. It includes such measures as the use of interceptors, bombers, antiaircraft guns, surface-to-air and air-to-air missiles, and electronic attack and the destruction of an air or missile threat both before and after it is launched. Other measures used to minimize the effects of hostile air action are cover, concealment, dispersion, deception (including electronic), and mobility. The primary purpose of AAW is to gain and maintain whatever degree of air superiority is required; this permits the conduct of operations without prohibitive interference by opposing air and missile forces. AAW's other purpose is force protection.

AAW uses both offensive and defensive means to accomplish its objectives and to directly support the warfighting functions of fires and force protection. Self-defense against enemy air is a task for all rotary-wing aircraft. Additionally, the low-altitude air defense (LAAD) battalion, VMFA, VMFA(AW), VMA, and HMLA are all specifically tasked to perform AAW. The Marine air

control squadron (MACS) provides personnel and equipment for the operation of the tactical air operations center (TAOC). The TAOC's mission is to detect, identify, and control the interception of hostile aircraft and missiles.

**(1) Offensive Anti-air Warfare.** Offensive anti-air warfare (OAAW) are operations conducted against enemy air assets and air defense systems before they can be launched or assume an attacking role. OAAW operations in or near the objective area consist mainly of air attacks that destroy or neutralize hostile aircraft, airfields, radar, air defense systems, and supporting areas. OAAW also includes attacks against enemy theater missile operations and suppression of enemy air defenses (SEAD). Offensive counterair [OCA] is the joint term for an operation that destroys, disrupts, or limits enemy air power as close to its source as possible.

**(2) Air Defense.** Air defense includes all defensive measures designed to destroy attacking enemy aircraft or missiles in the Earth's atmosphere or to nullify or reduce the effectiveness of an enemy attack. Air defense involves both active and passive measures.

**(a) Active Air Defense.** Active air defense includes the use of aircraft, air defense weapons, supporting weapons (i.e., weapons not primarily used in an air defense role), and EW. The approved joint term for this is defensive counterair (DCA).

**(b) Passive Air Defense.** Passive air defense includes all measures other than active defense that are taken to minimize the effectiveness of hostile air action. These measures include the use of protective construction, concealment, camouflage, deception, dispersion, cover, and electronic protection. Passive air defense is a command responsibility of every unit commander.

### c. Assault Support

Assault support contributes to the warfighting functions of maneuver and logistics. Maneuver warfare demands rapid, flexible maneuverability to achieve a decision. Assault support uses air-

craft to provide tactical mobility and logistic support to the MAGTF for the movement of high-priority personnel and cargo within the immediate area of operations (or the evacuation of personnel and cargo). It also uses Marine aerial refueler transport squadrons (VMGRs) to provide in-flight refueling. Specific assault support tasks are discussed in the following subparagraphs. See MCWP 3-24, *Assault Support*, for additional information.

**(1) Combat Assault Transport.** Combat assault transport provides mobility and logistic support to the MAGTF. It is used to deploy forces efficiently in offensive maneuver warfare, bypass obstacles, or quickly redeploy forces. Combat assault support allows the MAGTF commander to build up his forces rapidly at a specific time and location.

**(2) Air Delivery.** Air delivery is the transportation of equipment and supplies to FOBs or remote areas. Delivery can be accomplished with helicopters or loads can be air dropped from fixed-wing aircraft such as the KC-130. Air drops are normally used when surface or helicopter transports cannot be used because of range, closed lines of communications, a lack of adequate airfields, a prohibitive ground tactical situation, high tonnage, or reduced response time.

**(3) Aerial Refueling.** Aerial refueling allows MAGTF aircraft, both fixed- and rotary-wing, to conduct flight-ferrying operations, extend time on station, and extend mission range.

**(4) Air Evacuation.** Air evacuation is the transportation of personnel and equipment from FOBs or remote areas. This includes flights from areas of operations to secure rear areas, medical evacuations, and extraction of forces. Transport helicopters and fixed-wing transport aircraft perform air evacuations.

**(5) Tactical Recovery of Aircraft and Personnel.** The tactical recovery of aircraft and personnel (TRAP) is performed by an assigned and briefed aircrew for the specific purpose of the recovery of personnel, equipment, and/or aircraft.

TRAP is a subcomponent of combat search and rescue (CSAR) and/or joint combat search and rescue (JCSAR) missions, but it is only executed once the location of survivors is confirmed. It does not involve dedicating aircraft assets to locating survivors. Tactical recovery occurs once the general location of survivors is confirmed. A TRAP mission may include personnel to conduct a local ground search if required. Marine Corps tactical aircraft are not normally equipped to conduct the search portion of CSAR or the over water portion of search and rescue missions. The composition of a tactical recovery mission may vary from a single aircraft and aircrew to an assault support mission package that consists of multiple fixed-wing and rotary-wing aircraft with an on-board compliment of security, ground search, and medical personnel.

**(6) Air Logistical Support.** Air logistical support operations are conducted by fixed-wing aircraft and provide assault support of MAGTF forces on the ground. Air logistical support delivers troops, equipment, and supplies to areas beyond helicopter range and lift capability or when surface transportation is slow or unavailable.

**(7) Battlefield Illumination.** Battlefield illumination can be provided by both fixed-wing and rotary-wing aircraft. Illumination may be visible to the naked eye or invisible (i.e., visible only with night vision equipment). Battlefield illumination can last for a few minutes or several hours.

#### d. Air Reconnaissance

Air reconnaissance employs visual observation and/or sensors in aerial vehicles to acquire intelligence information. It supports the intelligence warfighting function and is employed tactically, operationally, and strategically. The three types of air reconnaissance are visual, multisensor imagery, and electronic. All aircraft units constantly perform visual air reconnaissance. The Marine tactical electronic warfare squadron (VMAQ), VMU, VMA, VMFA, VMFA(AW), HMLA, and other air reconnaissance platforms can be equipped with sensors to conduct other than visual reconnaissance. For additional information, see MCWP 2-11, *MAGTF Intelligence Collection*,

and MCWP 2-15.4, *Imagery Intelligence*, for more information.

**(1) Visual Reconnaissance.** Visual reconnaissance may be conducted by any airborne platform. It consists of an observer or pilot visually searching a route, point, or area. Visual aerial reconnaissance is frequently used in support of the delivery of offensive fires such as artillery support, naval surface fire support, or CAS.

**(2) Multisensor Imagery Reconnaissance.** Multisensor imagery reconnaissance includes photography from standard cameras, photograph and radar imagery from the advanced tactical aerial reconnaissance system (ATARS), and infrared imagery. Multisensor imagery reconnaissance is used to detect and pinpoint the location of enemy installations, facilities, and concentrations of forces. It is also used to support terrain analysis.

**(3) Electronic Reconnaissance.** Electronic reconnaissance is used to detect, locate, identify, and evaluate enemy electromagnetic radiation. Electronic reconnaissance is performed with passive interception equipment that recovers signals and determines signal direction, source, and characteristics. It gathers data that, when processed into intelligence, is used to update the electronic order of battle and technical intelligence.

#### e. Electronic Warfare

EW is any military action involving the use of electromagnetic and directed energy to control the electromagnetic spectrum or to attack the enemy. EW supports the warfighting functions of fires, command and control, and intelligence through the three major subdivisions: electronic attack, electronic protection, and electronic warfare support. Only the VMAQ is specifically equipped to perform all aspects of EW.

**(1) Electronic Attack.** Electronic attack is that division of EW that involves the use of electromagnetic energy, directed energy, or antiradiation weapons to attack personnel, facilities, or equip-

ment with the intent of degrading, neutralizing, or destroying enemy combat capability.

**(2) Electronic Protection.** Electronic protection involves the actions taken to protect personnel, facilities, and equipment from the effects of friendly or enemy employment of EW that degrade, neutralize, or destroy friendly combat capability.

**(3) Electronic Warfare Support.** Electronic warfare support is tasked by or under the direct control of an operational commander. It involves the actions needed to search for, intercept, identify, and locate sources of intentionally and unintentionally radiated electromagnetic energy for the purpose of immediate threat recognition.

**f. Control of Aircraft and Missiles**

The control of aircraft and missiles integrates the other five functions of Marine aviation by providing the commander with the ability to exercise command and control authority over Marine aviation assets. It enhances unity of effort and disseminates a common situational awareness. It involves the integrated employment of facilities, equipment, communications, procedures, and personnel. It also allows the ACE commander to plan operations and to direct and control aircraft and missiles to support accomplishment of the MAGTF’s mission. The control of aircraft and missiles supports the warfighting function of command and control. The ACE commander maintains centralized command, while control is decentralized and executed through the Marine air command and control system (MACCS), which is described in chapter 4.

The Marine air control group (MACG) is responsible for providing, staffing, operating, and maintaining the principal MACCS agencies. These agencies include the TACC, TAOC with the early warning/control (EW/C) center, Marine air traffic control detachment (MATCD), DASC, and the direct air support center (airborne) (DASC[A]). All Marine aircraft have the capability to provide some form of airborne coordination and control

during assault support missions, and HMLAs and VMFA(AW)s can provide FAC(A) or tactical air coordinator (airborne) (TAC[A]) services supporting the MACCS. The methods of aviation control are depicted in figure 2-2 and discussed in the following paragraphs.

**(1) Air Direction.** Air direction is the authority to regulate the employment of air resources (including both aircraft and surface-to-air weapons) to maintain a balance between their availability and the priorities assigned for their use. The purpose of air direction is to achieve a balance between the MAGTF’s finite aviation resources and the accomplishment of the ACE’s mission.

**(2) Air Control.** Air control is the authority to direct the physical maneuver of aircraft in flight or to direct an aircraft or surface-to-air weapons unit to engage a specific target. Air control includes airspace management and airspace control.

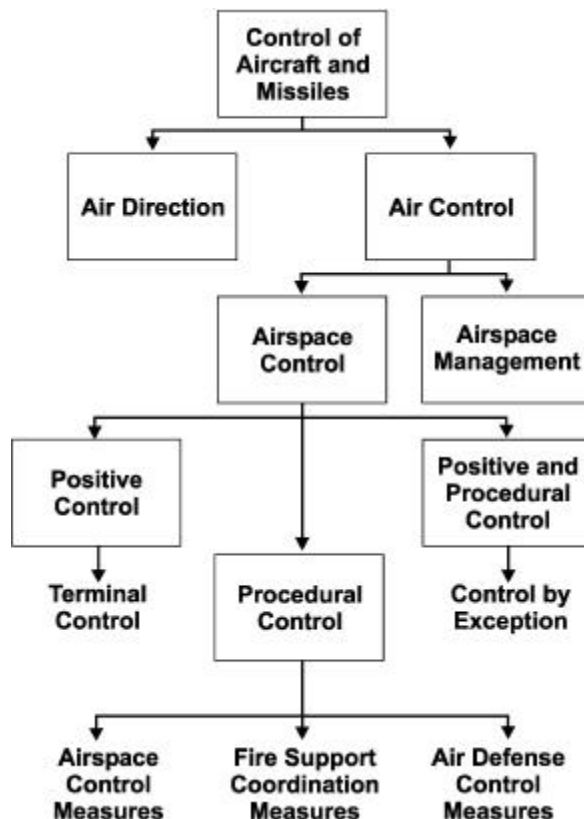

Figure 2-2. Categories of Air Control.

**(a) Airspace Management.** Airspace management is the coordination, integration, and regulation of the use of airspace based on defined dimensions. Commanders use airspace management to optimize the available airspace and to allow the maximum freedom consistent with the degree of acceptable operational risk. The MACCS provides the ACE commander with the ability to conduct airspace management.

**(b) Airspace Control.** Airspace control is the authority to direct the maneuver of aircraft so that the best use is made of assigned airspace. Airspace control provides for the coordination, integration, and regulation of the use of a defined airspace. It also provides for the identification of all airspace users. The authority to exercise airspace control is inherent to the commander whose unit is responsible for particular blocks of airspace, types of missions, or types of aircraft. Airspace control does not include measures to approve, disapprove, deny, or delay air operations. MACCS agencies accomplish airspace control through the use of positive control, procedural control, or a combination of the two. Positive control is a method of airspace control that relies on positive identification, tracking, and direction of aircraft within an airspace. It is conducted with electronic means by an agency with the appropriate authority and responsibility. Procedural control is a method of airspace control based on a combination of previously agreed and promulgated orders and procedures.

## 2002. Marine Aviation Organization

Administratively, Marine aviation is organized into three active duty and one reserve Marine aircraft wings (MAWs). MAWs are designed to provide units in support of MAGTF or other operations. Each MAW has a unique organizational structure (see app. A and fig. 2-3). The MAW may be reinforced with assets from other MAWs to provide the necessary assets to meet mission requirements. It is organized into a MAW headquarters, several Marine aircraft groups (MAGs),

a MACG, and a Marine wing support group (MWSG).

The wing headquarters and subordinate groups are task-organized based on the assigned mission. When the MAW is deployed as the ACE for a MEF, the MAW headquarters becomes the ACE's command element. Each group consists of specialized squadrons and/or battalions that perform one or more of the six functions of Marine aviation. The MACG contains the bulk of the MAW's command and control assets. The MWSG contains the personnel and equipment that are necessary to provide direct aviation ground support to the MAW. The MAW is capable of performing all six functions of Marine aviation. Through task organization, a wing can provide deployable detachments that are capable of accomplishing any or all Marine aviation functions. Aviation organizations smaller than a wing normally task-organize to provide only a specific portion of the six aviation functions.

The following paragraphs provide a brief description of the MAW's subordinate units and how they relate to the functions of aviation. Table 2-1 contains a summary of aviation units and corresponding functions. MCRP 5-12D, *Organization of Marine Corps Forces*, contains a detailed discussion.

### a. Marine Air Control Group

The MACG coordinates all aspects of air command and control, air reconnaissance, and air defense within the MAW. When deployed as part of the MAGTF ACE, it provides the command and staff functions for the MACG commander and coordinates the employment of aviation command and control equipment, facilities, and personnel in support of the ACE.

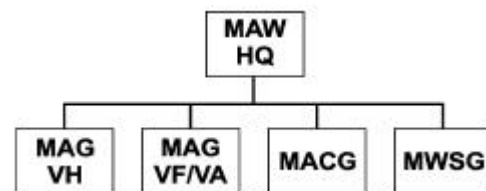

Figure 2-3. Notional Marine Aircraft Wing.

Table 2-1. Marine Aviation Units and Functions.

Type of Aviation Unit	AAW	Assault Support	OAS	EW	Air Reconnaissance	Control of Aircraft and Missiles
MAW	X	X	X	X	X	X
MACG	Support	Support	Support	Support	Support	X
MTACS						TACC
MASS		DASC	DASC		DASC	DASC
MACS	TAOC ATC	ATC	TAOC ATC	ATC	TAOC ATC	TAOC ATC
LAAD	X	Support			Support	X
MWCS						Communications
MWSG	Support	Support	Support	Support	Support	Support
MAG (VF/VA)	X	X	X	X	X	Support
MALS (fixed wing)	Support	Support	Support	Support	Support	Support
VMGR	Support	X	Support	Support	Support	DASC(A)
VMAQ	Support	Support	Support	X	X	Support
VMU	Support	Support	Support	Support	X	Support
VMFA	X	Escort	X	Support	X	Support
VMFA (AW)	X	Escort	X	Support	X	FAC(A)/TAC(A)
VMA	X	Escort	X	Support	X	Support
MAG (VH)	X	X	X	Support	X	Support
VMM	Self-defense	X	Support	Support	Support	Airborne control and coordination
MALS (rotary-wing)	Support	Support	Support	Support	Support	Support
HMH (CH-53D)	Self-defense	X	Support	Support	Support	Airborne control and coordination
HMH (CH-53E)	Self-defense	X	Support	Support	Support	Airborne control and coordination
HMM	Self-defense	X	Support	Support	Support	Airborne control and coordination
HMLA Utility	Self-defense	X	Support	Support	Support	Airborne control and coordination
HMLA Attack	X	X	X	Support	X	Airborne control and coordination

**X**—The unit performs that function of Marine aviation as part of its primary mission. However, all Marine aircraft are specifically designed to be multi-mission capable and provide significant support for multiple functions.

**Support**—The unit provides general support for that function in varying degrees based on equipment capabilities and the situation.

**Specifically indicated support (armed reconnaissance, DASC, escort, etc.)**—Many units perform a specific type of support for one or more of the six functions of Marine aviation. The ability to provide this type of support is often dependent on equipment and/or aircraft mission configuration or specialized personnel training, and it must be specifically requested. For MACG units, the MACCS agency provided by the unit is indicated.

The major task performed by the MACG is planning and coordinating the support of the command and control function of Marine aviation. The MACG ensures that its subordinate squadrons and battalions are organized, supplied, and prepared to execute the MACCS' mission.

**(1) Marine Tactical Air Command Squadron.** The Marine tactical air command squadron (MTACS) provides equipment, maintenance, and operations for the TACC of the ACE. It equips, operates, and maintains the majority of the manning for the current operations section of the TACC. It also provides and maintains a facility for the TACC future operations and future planning sections and installs and maintains associated automated systems. As a result of the recent merger of the Marine wing headquarters squadron (MWHS) into the MTACS, MTACS will also provide administrative, logistic, and supply support (including the wing commander's mess) for the Marine wing headquarters.

The MTACS's major task is to provide the command post for the ACE commander. This involves the planning and coordination of air operations, deployment and employment issues, and logistic and supply support.

**(2) Marine Air Control Squadron.** The MACS provides air surveillance, control of aircraft and surface-to-air weapons for AAW, continuous all weather radar and nonradar air traffic control (ATC) services, and airspace management in support of a MAGTF.

The MACS provides deployable detachments that are capable of air surveillance, airspace management, and control of aircraft and SAMs for AAW in support of the MAGTF. It also provides deployable detachments that can provide ATC services at existing or expeditionary airfields (EAFs) and remote area landing sites.

**(3) Marine Wing Communications Squadron.** The MWCS provides expeditionary communications for the ACE of a MEF, including the phased deployment of task-organized elements thereof.

The MWCS provides some of the ACE's major communications support, including planning and engineering. The squadron also provides operational systems control centers, digital backbone communications support, tactical automated switching and telephone services, electronic message distribution, external single-channel radio and radio retransmission communications, wide area network (WAN) and deployed local area network (LAN) servers, and support of cryptographic sites.

**(4) Marine Air Support Squadron.** A Marine air support squadron (MASS) provides DASC capabilities for control and coordination of fixed-wing and rotary-wing aircraft operating in direct support of MAGTFs. The MASS's major tasks include conducting operational planning for MAGTF direct air support operations; receiving, coordinating, and processing immediate requests for air support; providing equipment, facilities, and personnel for operation of air support elements; and maintaining continuous control of direct air support while displacing.

**(5) Low Altitude Air Defense Battalion.** The mission of the LAAD battalion is to provide close-in, low altitude surface-to-air weapons fires in defense of the MAGTF. LAAD battalions defend forward combat areas, maneuver forces, vital areas, installations, and/or units engaged in special or independent operations. Major tasks of the LAAD battalion include—

- 1 Providing support of subordinate batteries.
- 1 Maintaining a primary capability as a highly mobile, vehicle-mounted, and man-portable surface-to-air weapons component of the MAGTF.
- 1 Providing surface-to-air weapons support for units engaged in special and/or independent operations.
- 1 Providing for the separate deployment of subordinate batteries and platoons to accommodate special tactical situations and task organizations.

**(6) Marine Unmanned Aerial Vehicle Squadron.** The VMU operates and maintains a UAV system in order to provide unmanned aerial reconnaissance support to the MAGTF via the ACE TACC. VMU tasks include—

- 1 Conducting reconnaissance, surveillance, and target acquisition.
- 1 Performing airborne surveillance of designated target areas, MAGTF areas of interest and/or influence, and other areas as directed.
- 1 Performing airborne surveillance for search and rescue and TRAP.
- 1 Performing reconnaissance of helicopter approach and retirement lanes in support of vertical assaults.
- 1 Providing real-time target information to the DASC and fire support coordination center (FSCC).
- 1 Providing information to assist in adjusting indirect-fire weapons and to support and facilitate DAS and air interdiction.
- 1 Collecting battle damage assessments (BDAs).

## b. Marine Aircraft Group

The MAG provides the staff support necessary for the effective command of subordinate squadrons of the MAG. The MAG is usually composed of functionally similar aircraft squadrons and their support units. Table 2-2 delineates the types of squadrons and aircraft present in a MAG.

**Table 2-2. MAG Squadrons and Aircraft.**

Squadron Type	Aircraft Type	# of Squadrons <sup>1</sup>	# of Primary Aircraft Authorized <sup>2</sup>
VMA	AV-8B	7	16
VMFA	F/A-18A/C	12	12
VMFA (AW)	F/A-18D	6	12
VMAQ	EA-6B	4	5
VMGR	KC-130	5	12
VMAT	AV-8 Training	1	30
VMFAT	F/A-18 Training	1	12 F/A-18A/C 17 F/A-18D
VMFT	Aggressor Squadron F-5	1	11 F-5E 1 F-5F
VMGRT	KC-130 Training	1	8
VMU	UAV	2	5
HMH	CH-53E	6	16
HMH <sup>3</sup>	CH-53D	5	8
HMM	CH-46E	18	12
HMLA	UH-1N AH-1W	10	9 UH-1N 12 AH-1W
HMT HMMT(T)	Helicopter Training	HMM(T) 1 CH-46E 1 CH-53E 1 CH-53D 1 UH-1N/AH-1W	18 CH-46E 15 CH-53E 6 CH-53D 14 UH-1N 20 AH-1W
VMM	MV-22	TBD	12
VMMT	MV-22 Training	1	TBD

<sup>1</sup> The total number of squadrons, including reserve units.

<sup>2</sup> The primary aircraft authorization for each squadron is a fixed number. However, the actual number of aircraft in a squadron varies based on production timelines, scheduled depot-level maintenance cycles, aircraft transfers, etc.

<sup>3</sup> Although CH-53D squadrons have retained their HMH designation, they are considered medium lift like a CH-46E squadron, instead of heavy lift like a CH-53E squadron.



The MAG is the smallest aviation unit that is designed to conduct operations with no outside assistance except access to a source of supply. MAGs normally contain either fixed-wing or rotary-wing aircraft in order to streamline logistic support requirements. MAGs can be task-organized to include any combination of fixed-wing and rotary-wing aircraft, as well as other supporting units. A MAG can also be task-organized into an ACE for a particular mission in order to provide one or more aviation functions to a MAGTF. When it is deployed as a MAGTF's ACE, the MAG headquarters becomes the tactical command element for the ACE. Currently, there are two types of MAGs within the MAW: the fixed-wing MAG (MAG VF/VA) and the rotary-wing MAG (MAG VH).

The primary mission of a MAG (VF/VA) is to provide AAW and OAS support for MAGTF operations from a variety of main bases, FOBs, and aircraft carriers. The MAG may consist of any combination of VMAs, VMFAs, VMFA(AW)s, VMGRs, VMAQs, or Marine aviation logistics squadrons (MALs) (fixed wing). It also usually contains one or more training squadrons.

The primary mission of the MAG VH is to provide assault support for MAGTF operations in any location or environment required. The MAG VH may include any combination of HMLAs, Marine medium helicopter squadrons (HMMs), Marine heavy helicopter squadrons (HMHs), MALS, and one or more training squadrons. As the MV-22 is introduced into the fleet, all HMMs and most of the CH53D squadrons will eventually transition to Marine medium tilt-rotor squadrons (VMMs).

**(1) Marine Aviation Logistics Squadron (Fixed-Wing/Rotary-Wing).** The MALS provides aviation logistic support, guidance, and direction to MAG squadrons on behalf of the commanding officer. It also provides logistic support for Navy-funded equipment in the supporting MWSS, MACS, and Marine wing mobile calibration complex. There is normally one MALS in

each MAG VH and MAG VF/VA. The MALS provides—

- 1 Intermediate-level maintenance for aircraft and aeronautical equipment.
- 1 Aviation supply support for aircraft.
- 1 Class V(A) ordnance and ammunition logistic support.
- 1 Coordination with the MWSG, the MACG, the MAW calibration complex, and other supporting Navy and Marine Corps activities and/or agencies in planning for the support required to execute the Marine Aviation Logistic Support Program (MALSP).
- 1 Maintaining the capability to deploy and provide MALSP support packages.

**(2) Marine Aerial Refueler Transport Squadron.** The VMGR's primary tasks are to provide tactical aerial refueling service to Marine aviation units and to serve as an aircraft platform for the DASC(A). Other tasks include assault air transport for air-landed and air-delivered personnel, supplies, and equipment; ground refueling service to aircraft when other suitable means of aircraft refueling are not available; and air transport service for the evacuation of casualties and noncombatants. The VMGR maintains an all weather capability and the ability to operate from a variety of bases.

**(3) Marine Tactical Electronic Warfare Squadron.** The VMAQ conducts airborne EW in support of Fleet Marine Force (FMF) operations to meet the EW and air reconnaissance functions of Marine aviation. Major tasks include—

- 1 Conducting airborne electronic attack and EW support operations.
- 1 Conducting electronic attack in support of MAGTF training.
- 1 Processing and providing mission data on EW missions for updating and maintaining an electronic order of battle.
- 1 Maintaining the capability of operating from aircraft carriers, advance bases, and EAFs.

- | Maintaining the capability to operate during darkness and under all weather conditions.
- | Maintaining the capability to deploy or conduct extended-range operations that require aerial refueling.

**(4) Marine Fighter/Attack Squadron.** The VMFA intercepts and destroys enemy aircraft under all weather conditions and attacks and destroys surface targets.

*Note: In this publication, the term all weather is used to indicate that the aircraft can perform all or part of its primary mission in all “types” of weather, not all “extremes” of weather. This capability is linked more to the type of equipment on board the aircraft, than to the effect of the weather on the aircraft. For example, all Marine aircraft are designed with the capability to fly in fog, rain, sleet, snow, etc. However, only aircraft equipped with special sensors like radar can realistically perform their mission without visual references. The term adverse weather is used to indicate that, while the weather is bad, a visual reference can still be maintained.*

VMFA tasks include—

- | Intercepting and destroying enemy aircraft.
- | Maintaining the capability to attack and destroy surface targets.
- | Providing escort of friendly aircraft under all types of weather conditions.
- | Maintaining the capability to deploy and operate from aircraft carriers and advance bases.
- | Conducting day and night CAS under all types of weather conditions.
- | Maintaining the capability to deploy or conduct extended-range operations by using aerial refueling.
- | Maintain the capability to conduct SEAD operations.

**(5) Marine All-Weather Fighter Attack Squadron.** The VMFA(AW) attacks and destroys surface targets under adverse weather conditions during both day and night operations; conducts multisensor imagery reconnaissance; provides supporting arms coordination; and

intercepts and destroys enemy aircraft under all types of weather conditions. VMFA(AW) tasks include—

- | Conducting day and night CAS under adverse weather conditions.
- | Conducting day and night DAS under all weather conditions, including armed reconnaissance, radar search and attack, air interdiction, and strikes against enemy installations.
- | Conducting multisensor imagery reconnaissance, this includes pre-strike and post strike target damage assessment and visual reconnaissance.
- | Conducting day and night supporting arms coordination, including forward air control airborne, tactical air coordination airborne, and artillery and/or naval gunfire (NGF) spotting.
- | Intercepting and destroying enemy aircraft.
- | Maintaining the capability to operate from aircraft carriers, advance bases, and EAFs.
- | Maintaining the capability to deploy or conduct extended-range operations by using aerial refueling.
- | Maintaining the capability to conduct SEAD operations.

**(6) Marine Attack Squadron.** The VMA attacks and destroys surface targets under day and night visual meteorological conditions. It also provides helicopter escort. VMA’s major tasks include—

- | Conducting CAS, armed reconnaissance, air interdiction, and strikes against enemy installations.
- | Conducting air defense operations.
- | Maintaining the capability to operate during darkness and under instrument flight conditions.
- | Maintaining the capability of deployment or extended operations by employing aerial refueling.
- | Maintaining the capability to operate from aboard carriers, other suitable seagoing platforms, EAFs, and remote tactical landing sites.
- | Conducting armed escort missions in support of assault support operations.

**(7) Marine Heavy Helicopter Squadron (CH-53D).** The HMH (CH-53D) supports the assault support function of Marine aviation by providing assault helicopter transport of heavy weapons, equipment, and supplies during amphibious operations and subsequent operations ashore. CH-53D squadrons have retained their HMH designation, but only CH-53E squadrons are now considered to be capable of heavy lift. The CH-53D is now considered a medium lift helicopter, like the CH-46E. The main tasks for the CH-53D include—

- 1 Providing combat assault transport of heavy weapons, equipment, and supplies.
- 1 Providing combat assault transport of troops.
- 1 Conducting tactical retrieval and recovery operations for downed aircraft, equipment, and personnel.
- 1 Conducting assault support for evacuation operations and other maritime special operations.
- 1 Providing support for mobile FARPs.
- 1 Maintaining the capability to operate from amphibious shipping, other floating bases, and austere shore bases.
- 1 Maintaining the capability to operate at night, in adverse weather conditions, and under instrument flight conditions at extended ranges.

**(8) Marine Heavy Helicopter Squadron (CH-53E).** The HMH (CH-53E) provides assault helicopter transport of heavy weapons, equipment, and supplies during amphibious operations and subsequent operations ashore. The main tasks for the CH-53E include—

- 1 Providing combat assault transport of heavy weapons, equipment, and supplies.
- 1 Providing combat assault transport of troops. Conducting tactical retrieval and recovery operations for downed aircraft, equipment, and personnel.
- 1 Conducting assault support for evacuation operations and other maritime special operations.
- 1 Providing support for mobile forward arming and refueling points (FARPs).
- 1 Maintaining the capability to operate from amphibious shipping, other floating bases, and austere shore bases.

- 1 Maintaining the capability to operate at night, in adverse weather conditions, and under instrument flight conditions at extended ranges.
- 1 Maintaining the capability to deploy and conduct extended range operations by employing aerial refueling.

**(9) Marine Medium Helicopter Squadron.**

The HMM provides assault transport of combat troops in the initial assault waves and follow-on stages of amphibious operations and subsequent operations ashore. HMM's major tasks include—

- 1 Providing combat assault troop transport.
- 1 Providing combat assault transport of supplies and equipment.
- 1 Conducting assault support for evacuation operations and other maritime special operations.
- 1 Providing support for mobile FARPs.
- 1 Maintaining the capability to operate from amphibious shipping, other floating bases, and austere shore bases.
- 1 Maintaining the capability to operate at night, in adverse weather conditions, and under instrument flight conditions at extended ranges.
- 1 Augmenting local search and rescue assets and provide aeromedical evacuation of casualties.

Tactical HMMs will begin replacing the CH-46E and CH-53D helicopters with the MV-22 tilt-rotor aircraft beginning in fiscal year 2003.

**(10) Marine Medium Tilt-Rotor Squadron.**

The Marine medium tilt-rotor squadron (VMM) provides transportation of combat troops, supplies, and equipment across the spectrum of expeditionary operations. VMM's primary function is to provide combat assault troop transport. It also provides combat assault transport of supplies and equipment, as a secondary function. Other VMM tasks include—

- 1 Conducting combat assault support for evacuation operations and other maritime special operations.
- 1 Providing support for forward arming and refueling points.
- 1 Providing airborne command and control for assault support operations.

- 1 Maintaining a self-defense capability for air-to air and ground-to-air threats.
- 1 Maintaining the capability to operate from naval ships and expeditionary airfields.
- 1 Maintain the capability to operate at night, in adverse weather, and under instrument flight conditions from extended ranges.
- 1 Maintain the capability for deployment and/or extended range operations employing aerial refueling.
- 1 Augmenting local search and rescue assets.
- 1 Providing aeromedical evacuation of casualties from the field to suitable medical facilities or other aeromedical aircraft.
- 1 Performing organizational maintenance on assigned aircraft in all environmental conditions.

**(11) Marine Light/Attack Helicopter Squadron.** The HMLA provides combat utility helicopter support, attack helicopter fire support, and fire support coordination during amphibious operations and subsequent operations ashore. The primary tasks of utility helicopters include—

- 1 Providing an airborne command and control platform for command elements.
- 1 Providing armed escort for assault support operations.
- 1 Providing combat assault transport of troops, supplies, and equipment.
- 1 Providing airborne control and coordination for assault support operations.
- 1 Augmenting local search and rescue assets and provide aeromedical evacuation of casualties.
- 1 Conducting combat assault and assault support for evacuation operations and other maritime special operations.
- 1 Controlling, coordinating, and providing terminal control for supporting arms, including CAS, artillery, mortars, and NGF.
- 1 Providing fire support and security for forward and rear area forces.
- 1 Maintaining the capability to operate from amphibious shipping, other floating bases, and austere shore bases.
- 1 Maintaining the capability to operate at night, in adverse weather conditions, and under instrument flight conditions at extended ranges.

The primary tasks of attack helicopters include—

- 1 Providing fire support and security for forward and rear area forces.
- 1 Conducting point-target and/or antiarmor operations.
- 1 Conducting anti-helicopter operations.
- 1 Providing armed escort, control, and coordination for assault support operations.
- 1 Controlling, coordinating, and providing terminal control for supporting arms, including CAS, artillery, mortars, and NGF.
- 1 Conducting armed and visual reconnaissance.
- 1 Maintaining the capability to operate from amphibious shipping, other floating bases, and austere shore bases.
- 1 Maintaining the capability to operate at night, in adverse weather conditions, and under instrument flight conditions at extended ranges.

**(12) Marine Wing Support Group.** The MWSG's mission is to provide aviation ground support for the MAW and to provide command and control, administration, supply, and logistic support assets to subordinate units performing aviation ground support for Marine aviation. The MWSG's primary task is to provide the capability to establish and maintain airfields and FOBs, and their associated aviation ground support requirements, for the conduct of ACE operations in support of the MAGTF.

**(13) Marine Wing Support Squadron.** The Marine wing support squadron's (MWSS's) mission is to provide for all essential aviation ground support requirements for a designated fixed-wing or rotary-wing component of an ACE. The MWSS also provides aviation ground support for all supporting or attached units of the MACG. The MWSS's primary tasks include providing—

- 1 Internal airfield communications.
- 1 Weather forecasting and services.
- 1 Aircraft crash, fire, and rescue services.
- 1 Structural fire fighting services.
- 1 Aircraft and ground equipment refueling.
- 1 Essential engineering services.
- 1 Motor transport operations internal to the ACE.
- 1 Messing facilities.

- 1 Organic nuclear, biological, and chemical capabilities.
- 1 Routine and emergency sick call services.
- 1 Security and law enforcement services.
- 1 Air base command functions.

See MCWP 3-21.1, *Aviation Ground Support*, and MCWP 3-35.7, *MAGTF Meteorology and Oceanography [METOC] Support*, for additional information.

### 2003. Aviation Combat Element Task Organization

An ACE is the core element of a MAGTF that is task-organized to conduct aviation operations. It provides all or a portion of the six functions of Marine aviation. The ACE is usually composed of an aviation unit headquarters and various other aviation units or their detachments. It can vary in size from a small aviation detachment of specifically required aircraft to one or more MAWs. The ACE may contain other Service or foreign mili-

tary forces assigned or attached to the MAGTF. The ACE itself is not a formal command.

The ACE is task-organized to contribute to battlespace dominance in support of the MAGTF's mission, project combat power, and conduct air operations. The ACE is task-organized to support the MAGTF based on the MAGTF commander's mission and his estimate of the aviation capabilities required to accomplish that mission. The MAGTF commander presents these requirements to the Marine Service component commander, and the selection of actual aviation units or detachments is determined by the tasked wing commander(s). Selected assets are task-organized to meet the MAGTF commander's requirements.

The ACE is normally built around an existing aircraft unit (squadron, group, or wing) reinforced as necessary with the appropriate command and control, combat, combat support, and combat service support (CSS) (including aviation logistic) units and detachments. In creating an ACE, the operational requirements of the mission, capabilities and limitations of specific units and equipment, and the availability of units determine the choice of units, type of equipment, and source location. Marine aviation forms the ACE of the three standing MEFs. However, this is merely the starting point for constructing the ACE for a MEF in time of war. For actual deployment, the ACE would be reinforced with units and/or detachments from the other two active duty MAWs and the Reserves. If providing the ACE to a Marine expeditionary unit (special operations capable) (MEU [SOC]), the ACE will usually be sourced from a single MAW.

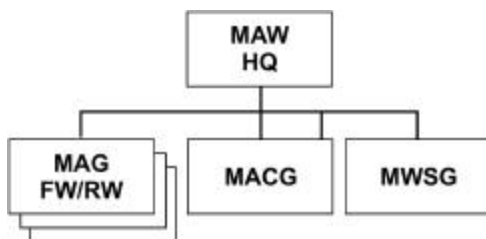

Figure 2-4. Notional MEF (ACE).

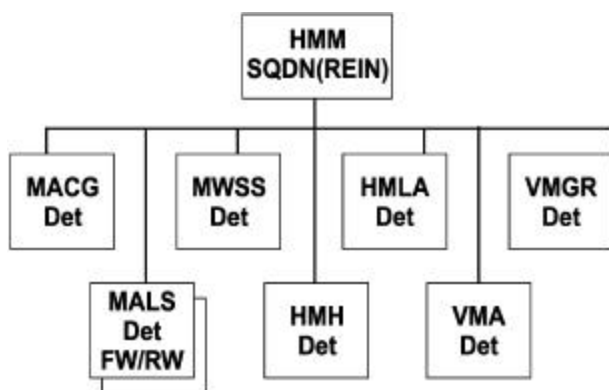

Figure 2-5. Notional MEU ACE.

Satisfying the MAGTF commander's aviation requirements is paramount. However, the identification of specific units for assignment to the ACE is driven by many factors in addition to the aviation functions required to support the MAGTF mission. Some of these factors are as follows:

- 1 Mode of deployment (amphibious shipping, strategic airlift or sealift, aircraft carriers, self-deployment, or a combination).
- 1 Mode of operations (from aircraft carriers and/or amphibious ships, FOBs, EAFs, or a combination).

- 1 Availability of supporting infrastructure (runways, shelters, electricity, and fuel).
- 1 Special qualifying criteria, training requirements and/or, operational experience.
- 1 Length and responsiveness of logistic support determines sustainability.
- 1 Replenishment rate of consumables, specifically aviation fuel and ordnance.
- 1 Anticipated missions and expected intensity of flight operations.

The MEF ACE can be built around one or more MAWs, or any portion of the MAW, that fulfills the required functions of Marine aviation. It may consist of one or more MAGs (fixed-wing or rotary-wing), a MACG, and a MWSG. The MAW also provides task-organized forces for smaller MAGTFs, such as a Marine expeditionary unit (MEU) and special purpose MAGTFs (SPMAGTFs). See figures 2-4 for a notional MEF and 2-5 for a notional MEU ACE.

The MEU ACE normally consists of a reinforced helicopter squadron that includes attack aircraft and two fixed-wing assault support aircraft (the latter are based in the continental United States). The notional MEF ACE is task-organized to provide assault support, low-level air defense, CAS, and airborne command and control. It includes a MACG detachment, MWSS detachment, fixed-wing MALS detachment, and rotary-wing MALS detachment.

SPMAGTFs, are organized, trained, and equipped with narrowly focused capabilities. Each SPMAGTF is designed to accomplish a specific mission, often of limited scope and duration. This

special purpose force may be any size but is normally small (the size of a MEU). It may contain other Service or foreign military forces assigned or attached to the MAGTF. The ACE composition for a SPMAGTF varies, but normally it is the size of a MEU ACE or smaller. For example, a SPMAGTF ACE may be created to operate and fly missions in support of host nation forces out of an EAF. In such a case, the SPMAGTF might consist predominantly of Marine aviation units supported by only a small security and logistic force. In other cases, the SPMAGTF ACE may represent a relatively small portion of the force.

Since the ACE is formed around an aviation headquarters, it will only contain one senior aviation unit. In the case of a MEF, the wing that comprises the ACE will be task-organized with units from a single wing and/or reinforced with as many groups and squadrons from other wings as are required to support the MAGTF's mission. For MEFs with multiple divisions in the GCE, the ACE may require the combined assets and personnel of several wings in order to meet this requirement. However, these assets and personnel remain under one ACE commander. This single ACE commander concept is essential to Marine aviation's doctrinal philosophy of centralized command and decentralized control (discussed in detail in chap. 4).

The ACE may be employed from ships or forward expeditionary land bases and can readily transition between sea and land bases without loss of capability. It has the capability to conduct command and control across the battlespace. The ACE is one of the two arms of the MAGTF specifically designed to conduct combat operations.

## Chapter 3

# The Role of Aviation in Combined-Arms Force Operations

*“On our drive to Manila, I depended solely on [Marine Aircraft Groups 24 and 32] to protect my left flank against possible . . . counterattack. . . . I can say without reservation that the Marine dive bombers are one of the most flexible outfits that I have seen in this war. They will try anything once, and . . . I have found . . . that anything they try usually pans out in their favor. [They] have kept the enemy on the turn. They have kept him underground and have enabled troops to move up with fewer casualties and with greater speed. I cannot say enough in praise of these men of the dive bombers . . . for the job they have done in giving my men close ground support in this operation.”<sup>3</sup>*

—MajGen Verne D. Mudge

The essential difference between Marine aviation and other aviation forces is that Marine aviation is designed to operate as an integral part of a combined-arms organization. Due to Marine Corps ground forces expeditionary nature and their limited indirect fire assets, ground forces rely heavily on the ACE to provide fire support in both close and deep operations. Therefore, the MAGTF must retain control of its aviation assets. But Marine aviation provides much more than just tactical fires in support of ground maneuver. It also provides the MAGTF commander with long-range fires (including electronic fires), intelligence collection, enhanced mobility, and force protection. It may also serve as the MAGTF’s main effort.

This chapter begins with a discussion of the six warfighting functions; discusses the operational environment; moves to a discussion of a number of key maneuver warfare ideas; then examines the role that aviation may play in conventional offensive and/or defensive operations, security operations, and MOOTW, as discussed in MCDP-1, *Warfighting*.

### 3001. The Six Warfighting Functions

Marine aviation provides a significant contribution to each of the warfighting functions during all phases of an operation. The warfighting functions are discussed in more detail in MCDP 1-2, *Campaigning*, and MCWP 5-1, *Marine Corps Planning Process*.

#### a. Command and Control

Command and control is the exercise of authority and direction by the commander over assigned forces in the accomplishment of the assigned mission. Command and control functions are performed through organization of personnel, procedures, equipment, communications, and facilities by the commander and staff to plan, direct, coordinate, and control forces and operations in the accomplishment of the mission. Aviation’s EW capabilities and control of aircraft and missiles contribute to this warfighting function.

## **b. Maneuver**

Maneuver refers to the employment of ground or aviation forces in order to gain a relative advantage over a threat by achieving a tactical, operational, or strategic objective. The advantage can be positional, temporal, or psychological. In conjunction with fires, maneuver generates tempo and combat power in the battlespace to overwhelm the threat. Mobility operations are inherent in maneuver. Mobility operations enhance the command's ability to move forces and supplies within the area of operations. Deception operations are integral to maneuver and usually involve elements of the other warfighting functions. Marine aviation elements may, in some cases, function as maneuver elements themselves. In any case, any scheme of maneuver will have aviation aspects, particularly in assault support and OAS.

## **c. Fires**

Fires include the organization, planning, coordination, and employment of all lethal and nonlethal attack systems that are available for use against threat resources and capabilities. This includes all sea-, air-, and land-based fire systems; the application of special operations capable forces; and psychological operations to achieve specified results. AAW, OAS, EW, and the control of aircraft and missiles are aviation functions that contribute to this warfighting function.

## **d. Intelligence**

Intelligence is the actions taken to collect information, process and analyze it to determine its relevance, and disseminate it to commanders in a timely manner to support decisionmaking. Intelligence constantly evaluates three of the environmental elements (infrastructure, threat, and noncombatants) of the battlespace. Intelligence focuses on revealing threat capabilities, dispositions, and intentions. It enables the commander to anticipate the threat's actions and reactions and promote tempo. Timely intelligence is imperative in developing an effective plan. Air reconnaissance and aviation EW capabilities are major contributors to this warfighting function.

## **e. Logistics**

Logistics encompasses all activities required to move and sustain military forces. The components of logistics include supplies, maintenance, transportation, general engineering, and health services. Aviation assault support is an important aspect of combat logistics.

## **f. Force Protection**

Force protection is the protection of the fighting potential of the command so that the commander can conduct decisive actions at a chosen time and place. It is the most difficult of the warfighting functions to execute because it requires the efforts of every member of the command. It involves both active and passive measures taken by the command that include individual protective measures, camouflage, hardening of facilities and vehicles, operational security procedures, dispersion, counterreconnaissance operations, counterintelligence operations, and preventive health efforts by medical and dental personnel. The synchronization of countermobility efforts, fires, and maneuver results in the generation of combat power and a tempo that overwhelms the threat's capability to interfere with friendly mission accomplishment. All aviation functions, especially AAW and air reconnaissance, can contribute to force protection.

## **3002. The Operational Environment**

Marine aviation is capable of operating in any environment and across the range of military operations. The challenge is to be equally prepared to operate in high- or mid-intensity combat scenarios against a technologically advanced and highly capable threat. Marine aviation must also operate against less advanced but numerically superior foes; in urban warfare; against diffused, ambiguous threats in undeveloped areas; and in adverse environmental conditions resulting from natural and/or manmade catastrophes, including nuclear, biological, chemical, or ecological events. Marine aviation may serve as either the main or supporting effort in offensive or defensive conventional



warfare, security operations, or MOOTW. MOOTW can include everything from counterinsurgency to disaster relief and other humanitarian operations.

### 3003. Organizational Adaptability

Given the uncertainties that are inherent in the operational environment, the greatest single requirement for Marine aviation is adaptability. The ACE can be task-organized to meet the MAGTF's needs. All ACE operations are conducted as part of an overall MAGTF air-ground concept of operations that is focused on the enemy. Aviation brings a degree of versatility, range, and agility not possessed by other elements of the MAGTF. It is not, however, a substitute for any other element of the MAGTF; its unique capabilities complement the other MAGTF elements' capabilities. For example, aviation under ideal circumstances may provide the MAGTF commander with long-range, 24-hour, all weather firepower to shape the battlespace and to exploit enemy critical vulnerabilities that are beyond the reach of other elements of the MAGTF. It enhances the operational and tactical mobility of the GCE by providing the capability to conduct vertical assaults as part of a ship-to-objective maneuver (STOM) or during sustained operations ashore. Aviation units can maneuver both rapidly and simultaneously throughout the battlespace, thereby enabling the commander to rapidly concentrate combat power at decisive points, anywhere and at any time, to set the stage for decisive action. The ACE also provides air defense for the MAGTF as part of the MAGTF force protection effort. The ACE's flexibility ensures that aviation combat and logistic capabilities are always available to the MAGTF.

Marine aviation is a highly visible asset. It provides the commander with options that are equally adaptable to combat and to MOOTW. Marine multirole aircraft provide a formidable capability that is useful across the range of military operations. MAGTF helicopters that carry combat-ready Marines into a hostile landing zone are the same platforms that evacuate noncombatants from

life-threatening danger. Fixed-wing assault support aircraft can deliver thousands of pounds of supplies to support ground operations or thousands of pounds of food for humanitarian assistance. Multirole fighter/attack aircraft can gain air superiority in combat or patrol a no-fly zone to support peace enforcement operations.

Similarly, Marine aviation command and control agencies can function in many diverse roles and environments. The ACE MACCS can facilitate command and control in joint and combined aviation operations such as direction of interceptor aircraft, countering missile threats to the joint or combined force, or tracking aircraft in support of counterdrug operations.

Marine aviation forces can operate outside the MAGTF in support of joint or combined operations. Fixed-wing and rotary-wing aircraft conducting flight operations near a country's coastline demonstrate military presence through the effective use of show of force operations. For example, in Bosnia Operations Deny Flight and Joint Endeavor created conditions under which all warring factions agreed to the cessation of hostilities and a monitored separation. Both operations stand as examples of the powerful presence that aviation can provide in efforts to establish and maintain peace.

Marine aviation is not constrained by the challenges of poor infrastructure and restrictive terrain. The ability to operate from austere sites, along with the reach, mobility, and sustainment provided by fixed-wing or rotary-wing transport aircraft, can overcome obstacles commonly encountered in humanitarian assistance operations. These capabilities are particularly beneficial when providing humanitarian relief services. Marine ATC units can establish ATC capabilities if they have been disrupted or destroyed or if none previously existed. The damage resulting from natural disasters may span tens of thousands of square miles. Damage to roads and other transportation infrastructure may hamper disaster relief efforts. Aviation's ability to operate in such areas, to sustain delivery efforts until the local infrastructure

is restored, and to respond rapidly to crisis situations can be crucial to success in disaster relief.

One of the key features of a Marine's expeditionary nature is the ability to expand, contract, and change the balance and focus of Marine forces. Because many crises are sudden and require a rapid response, the initial force arriving at the scene of a developing crisis is rarely sufficient to conduct decisive operations. The ability to respond effectively to such crises demands the ability to restructure an expeditionary force after its introduction into the theater without sacrificing continuity in operational capability. The ACE's modular structure allows rapid expansion into a larger force by adding the needed forces to each of the existing subordinate units. Similarly, should the situation require a lesser force or a different balance of capabilities, the ACE is easily redesigned to suit the situation. This flexibility in size and force includes the ability to expand into a joint or combined force.

### **3004. Marine Aviation and Maneuver Warfare**

The Marine Corps' warfighting philosophy emphasizes an integrated combined-arms approach that employs rapid, flexible maneuver. Maneuver warfare seeks to shatter the enemy's cohesion through a variety of rapid, focused, and unexpected actions. These actions create a turbulent and rapidly deteriorating situation for the enemy. The Marine Corps implements the maneuver warfare concept through air-ground teams—MAGTFs. These teams execute mission-type orders and maneuver in time and space, in combination with the application of fires, to create positional or temporal advantages over the enemy. Inherent in maneuver warfare is the need for speed in order to seize the initiative, dictate the terms of action, and keep the enemy off balance. Marine aviation plays a crucial role in the MAGTF's ability to conduct maneuver warfare by contributing task-organized ACEs that are specifically designed to provide the MAGTF with the necessary mobility, flexibility, force protection, and fires. The following subparagraphs discuss ways in which the

maneuver warfare concept relates to the employment of Marine aviation.

#### **a. Orienting on the Enemy**

Orienting on the enemy is fundamental to maneuver warfare. Maneuver warfare attacks the enemy "system." The enemy system is whatever constitutes the entity confronting us within our particular sphere. For a pilot, it might be the combination of air defense radars, surface-to-air missiles, and enemy aircraft that must be penetrated to reach the target. For an electronic warfare specialist, it might be the enemy's command and control network. For a MEF commander, it might be all the major combat formations within an area of operation as well as their supporting command and control, logistic, and intelligence organizations.

Economy demands that the MAGTF focus its efforts toward some object or factor of decisive importance to achieve the greatest effect at the least cost. Therefore, planners must understand both the sources of the enemy's strength and where the enemy is vulnerable.

We call a key source of strength a "center of gravity." It represents something without which the enemy cannot function. In broad terms, centers of gravity are the characteristics, capabilities, or localities from which a military force derives its freedom of action, physical strength, or will to fight. In practice, planners must distinguish between a strategic center of gravity and an operational center of gravity. A strategic center of gravity is an objective whose seizure, destruction, or neutralization will have a profound impact on the enemy leadership's will or ability to continue the struggle. It may be something tangible, like a political leader, a particular military force, or a capital city, or it may be intangible, like a popular belief in a cause or faith in eventual victory. An operational center of gravity, on the other hand, is normally an element of the enemy's armed forces. It is that concentration of the enemy's military power that is most dangerous to us or the one that stands between us and the accomplishment of our mission. The degree of danger that a force poses may depend on its size or particular capabilities, its location relative to ourselves, or the particular

skill or enterprise of its leader. MCDP 1-2 contains detailed information on centers of gravity and critical vulnerabilities.

Often we cannot attack enemy strengths directly because they are too well protected. Rather, we seek to attack a weakness that allows us to strike at the enemy's center of gravity indirectly, pitting our power against its weakness. A vulnerability cannot be critical unless it undermines a key strength. It also must be something that we are capable of attacking effectively.

However, even critical vulnerabilities may not be easy to attack. We may have to design a progressive sequence of actions that expose, create, or isolate a vulnerability that creates, over time, an opportunity to strike the decisive blow. An example would be to peel away the enemy's air defenses in order to permit a successful air attack on key command and control facilities. These facilities become the critical vulnerability that allow us to disable or destroy the enemy's air force, which is one of its centers of gravity.

In supporting the maneuver warfare tenet of orienting on the enemy, Marine aviation operations draw on both the center of gravity and critical vulnerability concepts. Aviation expands the operational reach of the MAGTF, potentially exposing a wide range of the enemy's potential critical vulnerabilities to attack. At the same time, it contributes greatly to the protection of friendly centers of gravity and critical vulnerabilities. Just as we pursue our enemy's critical vulnerabilities, we should expect the enemy to pursue ours. The ACE can play a proactive role in identifying those aspects of the enemy defense that are vulnerable to attack by air. The ACE is also responsible for planning air defense for the MAGTF and ensuring that the MAGTF's assets are not exposed to enemy aviation.

## **b. Philosophy of Command**

Our philosophy of command must support the way we fight. First and foremost, to generate the tempo of operations we desire and to best cope with the uncertainty, fluidity, and disorder of

combat, command and control must be decentralized. Marine aviation adheres to the MAGTF's maneuver warfare philosophy of centralized command and decentralized control. Typically, the ACE is commanded by a single commander located in the TACC, who then delegates the control of aviation assets to the subordinate agencies of the MACCS involved in the execution of operations.

## **c. Decisive Actions**

Decisive actions on the battlefield are those actions that most directly and expeditiously lead to the imposition of our will on the enemy by destruction of its forces and capability to wage warfare or the destruction of the enemy's will to resist. By concentrating our efforts and assets on actions that have a maximum impact on the enemy, we can minimize the number of decisive engagements required to attain victory.

It is possible for aviation forces to provide the decisive action in a battle. Normally, however, aviation forces are but one of several forces in the MAGTF that together conduct decisive actions. The MAGTF fights as a combined-arms team where the actions of the whole are greater than the sum of the actions of the individual parts. The MAGTF is more likely to be decisive (e.g., accomplish its mission) when it is employed as a whole, rather than employing its major subordinate elements sequentially, separately, or piecemeal. It does not rely on any one element alone to achieve a decisive action. Marine aviation makes its greatest contribution to MAGTF decisive action when the individual actions of aviation forces are integrated with those of the MAGTF's other elements.

## **d. Shaping Action**

To influence an action to our advantage, we must project our thoughts forward in time and space. Since war is inherently disorderly and we cannot expect to dictate its terms with any sort of precision, we attempt to shape the general conditions of war. We shape the battlespace to create situations of advantage. Shaping actions are intended to render the enemy vulnerable to attack, facilitate the maneuver of friendly forces, and dictate the

time and place for decisive battle. Shaping operations occur at all levels of war.

Aviation contributes to the MAGTF's shaping efforts in several ways. Aviation can make the enemy react against its will. It can impede or prevent the enemy from moving when it must. Aviation can hinder or prevent the massing of enemy forces and equipment by delaying the arrival of those forces, compelling enemy commanders to commit their forces piecemeal, and denying the enemy the supplies it needs to remain operational. Aviation can diminish the enemy's physical capabilities, upset its plan, and stifle its initiative. Aviation also helps shape the battlespace through the operational range and mobility that it provides Marine ground forces. The option for vertical insertion of ground forces adds yet another dimension to the ground commander's maneuver options.

Shaping actions, by all elements of the MAGTF, are also used to maximize aviation capabilities. Special operations forces can identify, disrupt, or destroy portions of the enemy's air defense system. Enemy aircraft can be destroyed on the ground through OAAW. Ground forces can seize an airfield needed as a FOB to extend the reach of aviation. CSS units can ensure the uninterrupted supply of fuel and ammunition at FARPs to enhance aviation responsiveness. The combined shaping efforts of all elements provide aviation with the freedom of action necessary to conduct successful air operations.

The MAGTF commander uses organic ACE aviation to set the course of operations in support of the JFC's campaign plan well in advance of the GCE's close combat operations. Successful MAGTF shaping maximizes aviation's ability to provide continuous, uninterrupted air support; delay enemy reinforcements through interdiction; degrade critical enemy functions or capabilities such as command and control, OAS, or logistics; and manipulate the enemy's perceptions.

The most important shaping operation performed by aviation is to gain air superiority. Air superiority is the degree of dominance in the air battle of one force over another that permits the conduct of

operations by the former and its related land, sea, and air forces at a given time and place without prohibitive interference by the opposing force. Successful MAGTF operations are contingent on the ability to operate freely within the battlespace and to deny the enemy freedom of action. The ACE's ability to shape both the close and deep battlespace, provide potent and responsive firepower and enhance mobility are key contributions to the MAGTF's achievement of battlespace dominance.

Air superiority is *essential* to the conduct of all functions of Marine aviation and therefore weighs heavily in creating conditions for successful aviation operations. Theater-wide air superiority cannot always be achieved immediately. At times, it may be necessary only to achieve local air superiority in order to facilitate a particular phase of a campaign.

Control of the air must be a priority for the entire MAGTF—not just the ACE. Air superiority extends beyond the realm of air-to-air combat. It requires the combined efforts of the MAGTF to neutralize or destroy enemy air defenses, airfields, and air command and control facilities. Once air superiority is achieved, aviation is free to provide effective support to the MAGTF.

This is also true for a joint force, where MAGTF actions, at least initially, will be integrated into the joint force's goal of achieving a degree of air superiority. One of the most important aspects of the initial air operations phase of Operation Desert Storm (January 17 to February 23, 1991) was to gain and maintain air superiority. The effectiveness of this action was illustrated by the fact that at no time during the subsequent ground operations phase (February 24 to 27, 1991) did Iraqi aviation possess either the capability or the will to interfere with our actions. Aviation operations seldom achieve a decisive result alone, but the advantage that air superiority provides in the conduct of MAGTF or joint operations is significant.

Although Marine aviation is designed largely for tactical operations, air superiority provides pro-

found operational and strategic benefits. During the island-hopping campaign of World War II, naval aviation's ability to attack virtually anywhere compelled the Japanese to spread their combat forces to defend everywhere (e.g., the concept of divide and conquer). It forced the Japanese to man literally hundreds of outposts. Thinly spread, the Japanese military proved unable to mass forces to withstand the combined might of U.S. air, land, and sea forces. This placed the Japanese on the defensive, created an opportunity to turn the course of the war in the Pacific, and achieved a decision.

### e. Decisionmaking

Decisionmaking is essential to the conduct of war since all actions are the result of decisions or of nondecisions. Warfare, by its very nature, is fraught with uncertainty. Uncertainty is exacerbated by the lack of time—a critical factor and a fundamental constraint in effective decisionmaking. The commander must always balance the value of gaining more information to mitigate uncertainty against the need to shorten the decisionmaking process.

Decisionmaking may be an intuitive process based on experience, particularly when time is extremely constrained. This will likely be the case at lower command echelons and in fluid, uncertain situations like those in an ATC center or in the cockpit. Alternatively, decisionmaking may be a more analytical process that is based on comparing several options. This will more likely be the case at higher echelons or in deliberate planning situations found in the future planning cell of the TACC, where the planning horizon is longer.

In execution, decisionmaking becomes a time-competitive process, and timeliness of decisions becomes essential to generating tempo. Tempo is the use of time as a weapon, and it is a critical consideration for the ACE commander. Being able to consistently generate a tempo of operations that the enemy cannot handle is crucial to the conduct of maneuver warfare. However, the highest tempo of operations, of which a force is capable, is not normally sustainable over extended periods.

Two levels of operational activity exist for aviation: sustained and surge. Sustained operations match the regeneration capabilities of the system (maintenance, manpower, and supply) to the utilization rate, thus achieving tempo that maintains a steady state. Surge operations can temporarily increase tempo in order to take advantage of battlefield opportunities. However, surge rates are obtained at the expense of all or a portion of the regenerative capability. Aviation units operating at a sustained rate can maintain a specific tempo of operations for an extended period of time. These same units operating at the surge rate can maintain a heightened tempo, but only for a limited period. The ACE commander must employ an appropriate mix of sustained and surge operations to control the operational tempo and maintain momentum without exhausting assets before the culminating point is reached.

### f. Mission Tactics

MCDP 1 and MCDP 6, *Command and Control*, both emphasize a command and control philosophy based on mission orders and mission tactics. This approach to command and control lies at the heart of maneuver warfare. Under this approach, seniors assign missions and explain their underlying intent but allow subordinates as much latitude as possible in the manner of accomplishment. It is the assignment of a subordinate a mission without specifying how the mission must be accomplished.

Mission tactics works in conjunction with aviation's philosophy of centralized command and decentralized control. It allows the senior commander to focus on higher-level concerns rather than the details of subordinate execution and serves as a contract between senior and subordinate commanders. The senior prescribes the method of execution only to the degree needed for coordination. The pace, complexity, and uncertainty of modern warfare necessitate this decentralization of control. The actual degree to which control is decentralized depends on the unique requirements of the specific situation. In some instances detailed and highly centralized control (e.g., ATC) is required. Centralized planning may be employed to enhance unity of effort and to

concentrate resources on an identified main effort. However, whenever possible, decentralized control is used to increase the speed and agility of the MAGTF—including its aviation arm.

Once the mission and plan have been prepared and briefed by the commander and the staff, subordinates are expected to exercise their initiative based on their understanding of the commander's intent. Aviation groups supply the aircraft and crews to meet the air tasking order (ATO) or air plan. They execute the assigned mission with the latitude necessary to accomplish it. MACCS agencies execute the plan for command and control without interference from the commander. Mission tactics are fundamental to Marine aviation operations and provide the flexibility necessary to adapt to rapidly changing situations and exploit fleeting opportunities.

#### **g. Commander's Intent**

There are two parts to any mission: the task to be accomplished and the reason or intent behind it. The task describes the action to be taken, and the intent describes the purpose of the action. The intent is part of every mission and is established by the commander assigning it. The commander's intent, clearly stated, enables unity of effort while decentralizing command and control. Once the mission is assigned, the commander develops a vision of how the operation should unfold in order to achieve the desired goal. This vision is shared with subordinates and includes the commander's intent. In the absence of detailed instructions, which are often unavailable in the midst of uncertainty and rapid changes in the battlespace, the intent provides the purpose and direction. The commander's intent is a device used at all command echelons within the MAGTF to enable subordinates to take the initiative. The MAGTF commander provides his intent to the ACE commander, the ACE commander provides his intent to his group commanders, and group commanders provide their intent to their squadron commanders. Prior to launching any aviation sortie, the mission commander, flight leaders, and individual pilots review the commander's intent and analyze how it applies to a particular mission so they will

be prepared to take the initiative as the situation dictates.

#### **h. Main Effort**

The main effort is the designated subordinate unit whose mission is most critical to overall mission success. Commanders design an operation carefully so that success by the main effort facilitates the success of the entire force. The main effort receives priority for support of any kind, and all other units support the main effort. Unlike commander's intent, which is a harmonizing device for subordinate initiative, the main effort is a unifying device that concentrates the MAGTF's efforts on the most important goal. Support of the main effort becomes an overriding factor in all decisions. When the MAGTF commander designates an element (ACE, GCE, or CSSE) of the MAGTF as the main effort, the other elements assume a supporting role. Thus, the main effort is the supported unit (one element of the MAGTF), while the supporting effort is provided by the supporting units (other elements of the MAGTF). The ability to shift the emphasis or to change the main effort from one element to another provides the MAGTF commander with flexibility. Any element of the MAGTF can be designated as the main effort. But, typically, only the ACE or GCE (or any portion thereof) with their inherent capability to maneuver and fire is designated as the main effort during combat operations. Since MOOTW encompasses a wide spectrum of operations, any of the three MAGTF elements (ACE, GCE, or CSSE) can be designated as the main effort. The ACE provides the MAGTF commander with firepower, flexibility, mobility, force protection, sustainability, and command and control, whether it is designated as the main effort or as the supporting effort.

Within the ACE, the concept of main effort is critical to the decisions made in the planning and execution of all aviation operations. With the ACE as the main effort, both the GCE and CSSE provide full support to ensure the success of the ACE. For example, the MAGTF commander might designate the ACE as the main effort when his operation plan or the JFC's campaign plan requires air superiority. In this case, the GCE and

CSSE could provide suppression of enemy air defenses or security for a FOB, or they could give priority in fuel and ammunition transportation to aviation units.

When the ACE is not the MAGTF's main effort, it assumes a supporting role. The ACE commander focuses all internal ACE resources (maintenance, manpower, supply, etc.) on the aviation functions and capabilities needed to support the MAGTF's main effort. The ACE commander may still designate a main effort within the ACE to achieve maximum ACE support to the MAGTF's main effort.

### **i. Surfaces and Gaps**

Surfaces are enemy strengths, also referred to as hard spots. Gaps are enemy weaknesses, also referred to as soft spots. We avoid enemy strengths and focus our efforts against the enemy's weaknesses. Whenever possible, we exploit existing gaps or we create gaps as needed. Surfaces and gaps are a tactical application of the operational concept of finding and attacking a center of gravity through a critical vulnerability. Surfaces and gaps can be, but are not always, centers of gravity or critical vulnerabilities. The commander strives to match the MAGTF's strength against the enemy's weakness.

Because of the fluid nature of war, gaps will rarely be permanent and will usually be fleeting. To exploit them requires flexibility and speed. The characteristics of Marine aviation make it ideally suited to temporarily fill gaps or to create gaps where none exist. Marine aviation's ability to rapidly and accurately concentrate firepower in a small area can be effective in creating gaps, and its continuous and aggressive aviation reconnaissance can seek out existing gaps. Once gaps are located, exploitation by fast-moving, mobile forces is critical. Aviation units can prevent enemy forces from closing the gap or they can be used to exploit the gap with assault support forces.

Exploitation usually occurs at a gap and extends the destruction of the enemy by maintaining continuous offensive pressure. Exploitation destroys

the enemy's cohesion. In a classic demonstration of maneuver warfare, the commander aims to render the enemy incapable of effectively resisting by shattering his moral, mental, and physical cohesion and his ability to fight as an effective, coordinated whole. Marine aviation offers the commander the speed and flexibility needed to support exploitation in a number of ways. It can provide direct air support to the main effort to prevent enemy forces from disengaging, withdrawing, reconstituting, or reinforcing. It can also support a committed reserve, either with firepower or mobility, at the moment when the opportunity for exploitation is realized. As enemy cohesion breaks down, the exploitation may develop into a pursuit.

The pursuit seeks to annihilate the enemy force once resistance has completely broken down. The condition of the enemy may determine whether an exploitation becomes a pursuit. The opportunity to conduct a pursuit is often fleeting and must be seized quickly by the commander. An effective pursuit requires the integrated efforts of the MAGTF's combat arms. During a pursuit, a direct-pressure force must have sufficient combat power to maintain pressure on the enemy. An encircling force must have continuous fire support and greater mobility than the enemy. The ability of aviation to move quickly to destroy enemy forces and deny them routes of escape makes aviation particularly valuable as an encircling force in the pursuit. The main effort may shift to the ACE during the pursuit to maintain pressure on the enemy or to destroy the enemy's will to resist.

### **j. Combined Arms**

Ten years after the first combat use of aircraft, the Italian air power theorist, Giulio Douhet, recognized the need to focus all combat forces toward one common goal. Douhet believed that the use of military ground, naval, and aerial forces in war should be focused on a single outcome—to win. Douhet cautioned that the best results can be obtained only by a proper apportioning of ground, naval, and aerial forces. To attain maximum effectiveness, these forces must be coordinated and in harmony with one another. These three forces

should function as ingredients (or factors) that produce a single product.

Douhet was speaking of combined arms. The MAGTF is the epitome of a combined-arms organization that focuses all combat forces on one common goal. Within the Marine Corps, combined-arms warfare is the full integration of various arms in such a way that to counteract one, the enemy must make itself more vulnerable to another. We present the enemy with more than one problem—a dilemma in which any action he takes makes him vulnerable to attack.

We accomplish combined arms through the tactics and techniques we use at the lower levels and through task organization at higher levels. In so doing, we take advantage of the complementary characteristics of different types of units and enhance our mobility and firepower. Firepower and mobility are complementary. Firepower aids mobility by causing the destruction and chaos necessary to render the enemy helpless to oppose our movement. Mobility enhances firepower by placing the attacker in a position where the target can be more accurately and effectively engaged. In combat, firepower and mobility are inseparable parts of a larger whole.

Firepower damages or threatens to damage enemy personnel, facilities, and equipment. Firepower sometimes fulfills the purpose of the mission—to destroy an enemy force or keep it from using a certain resource. Firepower aids our movement; e.g., using an air attack to destroy an enemy emplacement whose fires have immobilized our ground force. The benefits of firepower are not limited to physical destruction, but include the fear and mental chaos that firepower produces in the enemy. The appropriate application of firepower can have wide-ranging effects, from destruction to intimidation, to outright submission, to surrender. Operation Desert Storm is an example of the integrated application of aviation firepower in combined arms and its ability to condition and mold the enemy mentally. The innovative application of firepower and mobility in Operation Desert Storm created conditions for

success that allowed coalition forces to exploit the enemy's loss of will and means to fight.

Combining the effects of all combat resources is essential in achieving a decision. For example, consider the outcomes of Operation Strangle versus Operation Diadem. The difference in the outcomes illustrates the difference in effectiveness between aviation acting alone and aviation acting as part of a combined-arms team to achieve a decisive action.

Conducted in the spring of 1944, Operation Strangle was designed by the Allies to use aviation alone to destroy and disrupt German resupply efforts in Italy. Allied aviation assets were used to interdict railway systems that delivered supplies to the Germans. Unfortunately, without an Allied ground operation that supported the air effort, the German troops had a low supply expenditure rate and were actually able to stockpile resources during Operation Strangle.

Operation Diadem was conducted immediately following Operation Strangle. With the ground forces designated as the main effort, aviation supported the ground effort by interdicting targets in the German rear areas. The combined ground and aviation efforts soundly broke the German resolve and allowed the Allies to liberate Rome.

Within the ACE, the combined-arms concept is applied to the tailoring of mission packages to ensure that each has the appropriate mix of mutually supporting aviation capabilities, is focused on a common goal, and are guided by the commander's intent. The actual make-up of mission packages varies significantly and is usually situation dependent. For example, an assault support mission package may include transport helicopters; attack helicopters; fixed-wing AAW, EW, and attack aircraft; and command and control aircraft that represent all six functions of Marine aviation.

Success in battle requires the integration of many disparate efforts. Effective action in any one effort is rarely decisive in and of itself. However,



**Table 3-1. Functions of Aviation in Support of Warfighting Functions.**

Functions of Marine Aviation	Warfighting Functions and the Type of Support Provided					
	Command and Control	Maneuver	Fires	Intelligence	Logistics	Force Protection
Assault Support	Support	Primary	Support	Support	Primary	Support
AAW	Support	Support	Support	Support	Support	Primary
Air Reconnaissance	Support	Support	Support	Primary	Support	Support
EW	Support	Support	Primary	Primary	Support	Primary
OAS	Support	Support	Primary	Support	Support	Primary
Control of Aircraft and Missiles	Primary	Support	Support	Support	Support	Support

the overall effect is greater when all efforts are combined and coordinated toward a single goal. The Marine Corps achieves this combined-arms synergy by organizing and coordinating all of these efforts into six warfighting functions: command and control, maneuver, fires, intelligence, logistics, and force protection. The six functions (i.e., capabilities) of Marine aviation are integrated and provide a significant contribution to each of these warfighting functions. Table 3-1 aligns the six functions of Marine aviation with the six warfighting functions. This alignment is a necessary first step in redefining the six functions of Marine aviation in terms applicable to emerging doctrinal concepts.

### 3005. The ACE in Maneuver Warfare

A maneuver element is a distinct force that uses both fire and movement in engaging the enemy to generate and exploit an advantage over it as a means of achieving a specific objective. Using the Marine aviation forces of the ACE as a maneuver element provides a wide range of possibilities for mission accomplishment. It also increases the number of courses of action (COAs) available to the MAGTF commander. Marine aviation forces can provide essential fires in support of ground maneuver elements, assault support aviation can vastly enhance ground forces' mobility and maneuverability, or Marine aviation forces can also be used purely or predominantly as a maneuver

element. Aviation leaders and planners should be familiar with the variety of roles that combat forces can play in maneuver and think imaginatively about ways in which aviation can contribute.

Opportunities to employ and commit the ACE will depend on the nature of the enemy, the terrain, and the situation. By employing the ACE or its forces as a maneuver element, the MAGTF commander can fully capitalize on a force's range, speed, and agility. In that role, aviation can provide the main effort, provide a supporting effort, or serve as part of the MAGTF reserve.

Some tactical tasks and/or missions in which aviation units or forces may be able to perform as a maneuver element are listed below:

- | Envelopment (single, double, vertical).
- | Block.
- | Rupture.
- | Spoiling attack.
- | Counterattack.
- | Feint.
- | Demonstration.
- | Diversion.
- | Reconnaissance.
- | Raid.
- | Exploitation.
- | Pursuit.
- | Fix.
- | Screen.

- 1 Guard.
- 1 Cover.

*Note: While aviation forces are capable of performing the tasks and/or missions listed above, they will seldom execute them alone. Marine Corps doctrine dictates that Marine forces operate as a combined-arms team, and most tasks and/or missions will be conducted with a variety of integrated, mutually supporting forces.*

### 3006. Aviation in Offensive and Defensive Operations

The six functions of Marine aviation each play a significant role in both offensive and defensive operations. Because aviation inherently assumes an offensive role, it supports either offensive or defensive operations in exactly the same way. Aviation can continue offensive operations while the GCE is conducting defensive operations. The ACE commander apportions aviation assets as needed to best support the concept of operations and its assigned tasks and missions while remaining consistent with the MAGTF commander's intent.

#### a. Offensive Operations

The MAGTF conducts four types of offensive operations: movement to contact, attack, exploitation, and pursuit. It uses five forms of maneuver to effect offensive operations:

- 1 A *frontal attack* can create a gap through which the attacking force can conduct a penetration. Aviation forces use fires to create gaps in the enemy's front or to prevent or delay enemy reinforcements reaching the front lines.
- 1 A *penetration* is accomplished by concentrating overwhelmingly superior combat power on a narrow front and in depth in order to rupture the enemy's position and widen the gap. Mechanized and aviation forces are used to rupture the enemy's position and exploit the rupture.
- 1 A *flanking attack* is directed at the flank of an enemy. A supporting effort engages the enemy's front with fire and maneuver, while the

main effort maneuvers to attack the enemy's flank. Aviation forces support the main and supporting efforts as needed.

- 1 An *envelopment* uses attacking forces to bypass the enemy's principal defensive positions to secure objectives to the enemy's rear. The operational reach and speed of aviation forces make them an ideal force to conduct envelopments.
- 1 A *turning movement* uses attacking forces to pass around or over the enemy's principal defensive positions to secure objects deep in the enemy's rear. Aviation forces may serve as fixing forces or conduct the exploitation and pursuit in a turning movement.

In today's nonlinear battlespace, it is likely that several combinations of different types of operations and forms of maneuver will occur simultaneously. The ACE, with an area of operations that matches that of the entire MAGTF, must carefully allocate its assets to ensure a focus of effort that is responsive to the constantly changing situation. Depending on the circumstances, the ACE can support all forms of maneuver. Whether aviation provides the main or a supporting effort, its contribution with the six functions of Marine aviation in all types of offensive operations is significant. The ACE commander ensures that the focus of aviation remains commensurate with the MAGTF commander's priorities.

#### b. Defensive Operations

Defensive operations represent a coordinated effort to defeat the enemy and prevent it from achieving its objective. The purpose of defensive operations is to cause an enemy attack to fail and to achieve specific objectives, such as gaining time. These operations act as a prelude to offensive operations or serve to protect friendly forces and centers of gravity. An effective defense is never passive. Commanders at every level seek every opportunity to seize the initiative and shift to the offensive. The ACE is no less dynamic in defensive operations than in offensive operations, and it continuously seeks to create and exploit opportunities in order to defeat the enemy. The two fundamental types of defense are mobile defense and position defense. Commanders will rarely use one type or the other exclusively.

**(1) Mobile Defense.** A mobile defense is the defense of an area or position in which maneuver is used together with fire and terrain to seize the initiative from the enemy. A mobile defense focuses on the destruction of the enemy by permitting him to advance into positions that expose him to counterattack by a strong, mobile reserve. Minimal force is placed forward to canalize, delay, disrupt, and deceive the enemy as to the actual location of our defenses. By retaining the mobile forces until the critical time and place are identified, the commander can then focus combat power in violent and rapid counterattacks throughout the depth of the battlespace. Marine aviation provides vital support to all defending forces and may serve as the main or only counterattack force.

**(2) Position Defense.** A position defense (sometimes referred to as an area defense) places the bulk of the defending force in selected tactical positions (where the decisive battle will be fought). It denies the enemy critical terrain or facilities. A position defense focuses on the retention of terrain by absorbing the enemy into a series of interlocked positions from which he can be destroyed, largely by a combination of fire and maneuver. Principal reliance is placed on the ability of the forces in the defended positions to maintain their positions and to control the terrain between them. Marine aviation can provide the fires necessary for this form of defense.

## 3007. Aviation in Security Operations

Security is an aspect of all operations, whether offensive, defensive, or retrograde. Security operations are assigned missions. They involve the measures taken by a unit to protect itself against all acts that might impair its effectiveness. There are three types of security missions: screen, guard, and cover. Each of these missions entails placing a force between the enemy and our main force. As part of a task-organized security force, Marine aviation can provide various functional capabilities that extend a security mission's reach, responsiveness, and effectiveness. Depending on the nature of the enemy, weather, and terrain,

fixed-wing and/or rotary-wing aircraft may be able to perform the security mission by themselves. However, most security operations include a mutually supporting mix of forces.

### a. Screen

A screen observes, identifies, and reports information. It fights only in self-protection and—

- 1 Provides early warning of enemy approach.
- 1 Gains and maintains enemy contact and reports enemy activity.
- 1 Conducts counterreconnaissance within its capabilities.
- 1 Impedes and harasses the enemy within its capabilities.

A screen provides only surveillance and early warning of enemy action, not physical protection. It can be employed as an economy-of-force measure in a low-risk area because it provides security on a broad frontage with limited assets. Marine aviation combat forces are ideally suited to performing a screen because of the large areas to be screened during rapid and deep offensive operations. However, the cost in resources over time is a factor. For example, a screen consisting of one section of fighter and/or attack aircraft may require commitment of an entire squadron plus supporting aircraft (e.g., to provide EW and target acquisition) to ensure 24-hour coverage. Also, surveillance from the air has certain limitations and the enemy may have the ability to conceal its forces and facilities from aerial observation.

### b. Guard

A guard protects the main force from attack, direct fire, and ground observation by engaging the enemy in order to gain time while also observing and reporting information. It also—

- 1 Provides early warning of enemy approach.
- 1 Provides maneuver space to the front, flanks, or rear of the force.
- 1 Screens, attacks, defends, or delays (within its capabilities) to protect the force.

An advance guard provides early warning, develops the situation, and provides time and maneuver

space for an attacking force. A flank guard operates to the flank of a moving or stationary force to protect it from enemy ground observation, direct fire, and surprise attack. A flank guard must protect the entire depth of the main force's flank. A rear guard protects the rear of the column from hostile forces. It attacks, defends, and delays as necessary. The commander may order the guard to hold for a specified period of time. Marine aviation's reconnaissance capabilities, speed, range, firepower, and mobility make it ideal for a guard mission.

### c. Cover

A covering force operates apart from the main force to intercept, engage, delay, disorganize, and deceive the enemy before it can attack the main body. It prevents surprise during the advance. It also—

- 1 Gains and maintains contact with the enemy.
- 1 Denies the enemy information about the size, strength, composition, and intention of the main force.
- 1 Conducts counterreconnaissance and destroys enemy security forces.
- 1 Develops the situation to determine enemy dispositions, strengths, and weaknesses.

Aviation forces assets may provide covering forces because of their speed, range, reconnaissance, and communications capabilities. A cover screens, guards, attacks, defends, and delays as necessary to accomplish its mission. It is a self-contained maneuver force that operates beyond the range of friendly artillery positioned with the main force. A covering force may be task-organized (including infantry and aviation forces, artillery, and combat service support) to operate independently. The cover mission may be expressed in terms of time or enemy disposition (e.g., delay the enemy for 3 hours before battle handover or delay the enemy until the advance guard is defeated).

## 3008. Aviation in Military Operations Other Than War

MOOTW involves the use of military forces in situations other than large-scale, sustained military operations. MOOTW focuses on deterring war, resolving conflict, promoting peace, and supporting civil authorities in response to domestic crises. As in war, MOOTW's goals are to achieve national objectives as quickly as possible and to conclude operations on terms that are favorable to the United States and its allies. MOOTW may involve elements of both combat and noncombat operations and may occur during either peacetime or war. JP 3-07, *Joint Doctrine for Military Operations Other Than War*, lists the following 16 types of MOOTW:

- 1 Arms control.
- 1 Combatting terrorism.
- 1 Department of Defense support to counterdrug operations.
- 1 Enforcement of sanctions and/or maritime intercept operations.
- 1 Enforcing exclusion zones.
- 1 Ensuring freedom of navigation and overflight.
- 1 Humanitarian assistance.
- 1 Military support to civil authorities.
- 1 Nation assistance or support to counterinsurgency, which includes—
  - 1 Security assistance.
  - 1 Foreign internal defense.
  - 1 Humanitarian and civic assistance.
- 1 Noncombatant evacuation operations (NEOs).
- 1 Peace operations, which include—
  - 1 Peace enforcement.
  - 1 Peacekeeping.
  - 1 Operations in support of diplomatic efforts (which include preventive diplomacy, peacemaking, and peace building).
- 1 Protection of shipping.
- 1 Recovery operations.
- 1 Show of force operations.
- 1 Strikes and raids.
- 1 Support to insurgency.

NEOs involve the protection and subsequent removal of noncombatants from potentially hostile or dangerous situations. Like raids, NEOs involve the swift insertion of a force, the temporary occupation of objectives, and a planned withdrawal. It is the most frequently conducted MOOTW by Marine forces. Marine aviation is a critical resource in the conduct of NEOs.

Marine aviation is versatile enough to deliver security forces to a remote area, evacuate threatened noncombatants, conduct rapid force withdrawal, and provide covering and supporting fires throughout. Its speed and mobility generate tempo, often allowing friendly forces to act before opponents can react. The inherent flexibility and capabilities of aviation, coupled with the forward presence of the MAGTF, make Marine aviation an ideal asset for MOOTW. For example, during January 1991, while conducting training for Operation Desert Storm off the coast of Oman, the 4th Marine Expeditionary Brigade received orders to conduct a NEO in Mogadishu, Somalia. While elements of the 4th Marine Expeditionary Brigade

were steaming from Oman to Somalia, MAGTF aircraft were launched to begin the NEO. Thereby demonstrating Marine aviation's flexibility to rapidly transition from combat to MOOTW.

Another important consideration is the ACE's logistic capabilities. The ACE's logistic capabilities will sometimes prove far more important than firepower in a MOOTW. On April 29, 1991, a cyclone killed more than 130,000 people in Bangladesh. The country's entire infrastructure along the Bay of Bengal was destroyed, leaving an estimated 3 million people homeless. Operation Sea Angel provided MAG-50 helicopters that were loaded with supplies, food, water, water-making facilities, medicine and medical units, communications and liaison teams, area air reconnaissance, and basic air transportation. By the time the amphibious task force departed Bangladesh on May 29th, Marine aircraft had flown 1,167 helicopter sorties in 1,114 flight hours, moved 5,485 passengers, and delivered close to 700 tons of relief supplies.

## Chapter 4

# Command and Control of Marine Aviation Operations

*“The lines of communication are part of that unity. They link the army to its base, and must be considered . . . its arteries. . . .*

*These arteries, then must not be permanently cut, nor must they be too long or difficult to use.”<sup>4</sup>*

—Carl von Clausewitz

The ultimate objective of command and control is to effect the conduct of military action. Command and control includes activities such as gathering and analyzing information, making decisions, organizing resources, planning, communicating instructions and other information, monitoring results, and supervising execution. The principal objectives of the MACCS are to enhance unity of effort, integrate elements of the command and control system, and help maintain the commander’s situational awareness. The MACCS facilitates these objectives by providing the command and control architecture to integrate and execute aviation operations. It uses both mission control and detailed control, with emphasis on mission control. The MACCS supports the MAGTF philosophy of centralized command and decentralized control.

### 4001. Command Relationships

Command relationships consist of the interrelated responsibilities between commanders as well as the authority of commanders in the chain of command. The JFC organizes forces as needed to accomplish the assigned mission. The organization provides for unity of effort, centralized planning, and decentralized execution. The JFC establishes subordinate commands, establishes appropriate command and support relationships, and assigns responsibilities. Command relationships may differ from one operation to another; therefore, they

require clear definition in directives issued at the JTF level.

As clearly stated in JP 0-2, forces, not command relationships, are transferred between commands. When forces are transferred, the command relationship the gaining commander will exercise over those forces must be specified by the JFC. Therefore, when forces are **assigned** from one command to another (which is relatively permanent), the combatant commander will exercise combatant command (command authority) and the subordinate JFC will exercise OPCON or tactical control (TACON) over assigned forces. When forces are **attached** from one command to another (which is relatively temporary), the JFC will exercise OPCON or TACON, as specified, over the attached forces. These same rules apply to forces assigned or attached to the MAGTF.

The following subparagraphs briefly describe relevant command relationships. For more details, see JP 3-0, *Doctrine for Joint Operations*.

#### a. Operational Control

OPCON is the authority to perform the functions of command over subordinate forces that involve organizing and employing commands and forces, assigning tasks, designating objectives, and giving authoritative direction necessary to accomplish the mission.

## b. Tactical Control

TACON is the command authority over assigned or attached forces or commands, or over a military capability or force made available for tasking, that is limited to the detailed and, usually, local direction and control of movements or maneuvers necessary to accomplish missions or tasks assigned. A Marine aviation unit can be under TACON of another component commander in a joint force even though the Marine component commander retains command.

## c. Support

Support relationships are established by a superior commander between subordinate commanders when one organization should aid, protect, complement, or sustain another force. Establishing supported and supporting relationships between components is a useful option that is needed to accomplish varying tasks. Each subordinate element of the joint force can support or be supported by other elements. Unless limited by the establishing directive, the commander of the supported force will have the authority to exercise general direction of the supporting effort. General direction includes the designation and prioritization of targets or objectives, timing and duration of the supporting action, and other instructions necessary for coordination and efficiency. The supporting commander has the responsibility to ascertain the needs of the supported commander and to fulfill those needs within existing capabilities. At the same time, the supporting commander must stay consistent with priorities and requirements of other assigned tasks.

MCWP 6-2, *MAGTF Command and Control*, describes four categories of support: general, direct, mutual, and close. General support is the action that is given to the supported force as a whole rather than to a particular subdivision thereof (e.g., the ACE in general support of the entire MAGTF). Direct support is a mission that requires a force to support another specific force and authorizes it to directly answer the supported force's request for assistance (e.g., an attack squadron in direct support of one subordinate unit of the GCE). Mutual support is the action that

units render each other because of their assigned tasks, their positions relative to each other, and their inherent capabilities. Close support is the action of the supporting force against targets or objectives that are sufficiently near the supported force. This close proximity requires detailed integration or coordination of the supporting action with fire, movement, or other actions of the supported force (e.g., aviation units providing CAS to units in contact).

## 4002. Aviation Combat Element Command and Support Relationships

Central to the concept of employment for the ACE is the philosophy of centralized command and decentralized control. The commander needs to plan, direct, and coordinate all aspects of aviation employment for the MAGTF (i.e., centralized command). The ACE commander also wants to optimize the flexibility, versatility, and responsiveness of aviation by allowing control of assets to be conducted by subordinate agencies. These subordinate agencies are both responsive to the commander and in touch with the changing dynamics of the battle (i.e., decentralized control). Plans and orders are brief and general. Execution depends on the sound judgment of well-trained subordinates, their initiative, and their understanding of the commander's intent. This style of command and control supports rapid decision-making in a time-constrained environment. It allows the ACE to maintain a high operational tempo. The tasks that must be accomplished by centralized command are as follows:

- 1 Planning aviation operations.
- 1 Planning use of the battlespace.
- 1 Planning and coordinating the availability of aircraft, crews, ordnance, fuel, and facilities.
- 1 Coordinating Marine aviation with joint and multinational aviation operations and resources.
- 1 Tasking Marine aviation.
- 1 Directing and coordinating the employment of Marine aviation.

Tasks that the ACE commander expects the MACCS to perform through decentralized control include the following:

- 1 Executing aviation operations through the six functions of Marine aviation.
- 1 Providing air and missile defense to friendly units within the operating area.
- 1 Managing and controlling the air portion of the MAGTF battlespace.
- 1 Coordinating with joint and multinational air control agencies.
- 1 Executing the MAGTF ATO or air plan.
- 1 Providing timely and accurate information to the subordinate commanders to support tactical decisions.

**a. General Support**

The command support relationship established for the ACE by the MAGTF commander is almost always in general support of the MAGTF. This command relationship supports the philosophy of centralized command and decentralized control (see fig. 4-1). Since availability of aviation assets for mission tasking rarely meets the demand, the MAGTF commander keeps the ACE in general support of the MAGTF. This allows Marine aviation to fight or to provide support throughout the MAGTF area of operations and allows the most efficient and effective allocation of aircraft to the

MAGTF. This process is orchestrated through the air tasking cycle, allowing flexible and prioritized tasking. By using and completing the air tasking cycle, planners can ensure that finite aviation assets are allocated to achieve maximum effect with correct prioritization based on the main effort.

The ACE will be assigned the role of general support and supports the MAGTF commander’s main effort. The general support command relationship is a formal relationship that is established between the MAGTF and ACE commanders. This relationship provides the ACE commander the most flexible, efficient, and effective means of apportionment, allocation, and prioritization of all aviation assets in support of the MAGTF. The ACE commander retains centralized command over the subordinate units, including establishing the priority of their efforts. This prevents supporting aviation units from dealing directly with various GCE and CSS agencies. Sorties allocation will be promulgated through the ATO cycle to requesting units. The ACE commander exercises decentralized control of these sorties through the MACCS. For example, a GCE or CSSE unit will submit requests for immediate air support through the DASC or preplanned air support requests to the TACC. The ACE commander maintains flexibility in how and when to fill those requests as long as the MAGTF commander’s apportionment and prioritization guidance is met.

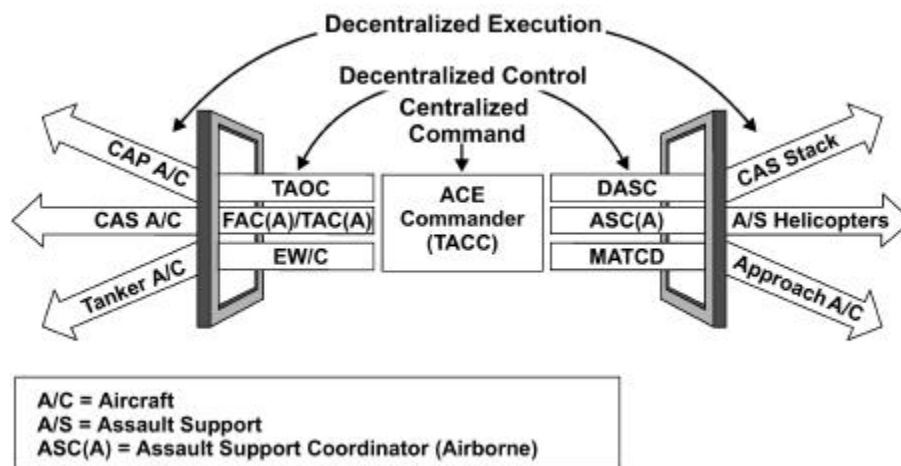

Figure does not display all control agencies or executors.

**Figure 4-1. Centralized Command and Decentralized Control.**



## b. Direct Support

Direct support is a mission requiring a force to support another specific force and authorizing it to answer directly the supported force's request for assistance. This support relationship is rarely established by the MAGTF commander for aviation units due to the scarcity of fixed-wing and rotary-wing assets. The ACE will normally be in general support of the MAGTF. With the designation of an aviation unit to the direct support role comes the requirement to establish direct liaison, direct communications to receive critical information, coordination of local security, and logistic support from the supported unit.

The MAGTF commander will rarely establish a direct support relationship between the ACE, GCE or CSSE. If a direct support relationship exists, it is not a command support relationship that is designated between higher, lower, and adjacent echelon commanders within the MAGTF. These types of support relationships usually exist only within the context of mission tasking, where individual sorties are allocated for a specific MAGTF unit conducting a particular mission (usually of short duration). Since these sorties do not represent the ACE's subordinate units, the ACE's general support command relationship does not change. When ACE units are assigned these types of command support relationships, they will, in most cases, be aviation ground units.

An ACE unit assigned a direct support role is immediately responsive to the needs of the supported unit. It furnishes continuous support to that unit and coordinates its operations to complement the concept of operations of the supported unit. The direct support role creates a one-to-one relationship between supporting and supported units. The higher headquarters of the supporting and supported units becomes involved only on a "by exception" basis. However, each unit must keep its higher headquarters informed of its operations and plans. Examples include an attack squadron in direct support of one subordinate unit of the GCE, a helicopter section in direct support of a maneuver battalion, or a LAAD battery in direct support of an infantry battalion.

*Note: Mutual and close support relationships are not usually established within the MAGTF context; however, LAAD units may find themselves in such relationships during joint or multinational operations.*

## 4003. Marine Aviation Command Relationships in a Joint Force

Within a joint force, JFCs may establish support relationships to enhance unity of effort for given operational tasks, emphasize or clarify priorities, provide a subordinate with an additional capability, or combine the effects of similar assets. Aviation is often placed in a supporting relationship but can be either the supported or supporting force. The JFC can organize and conduct operations through Service component commanders, functional component commanders, or a combination of the two.

### a. Service Components

Conducting operations through Service components has certain advantages, including clear and uncomplicated command lines. This relationship is appropriate when stability, continuity, economy, ease of long-range planning, and scope of operations dictate preserving the organizational integrity of Service forces. These conditions apply when most of the required functions in a particular dimension are unique to a single-Service force or when Service force capabilities or responsibilities do not significantly overlap.

When the JFC conducts joint operations through Service component commanders, the Marine Corps component commander and the other Service component commanders have OPCON and ADCON of their assigned Service forces (see fig. 4-2). Marine aviation forces under this command relationship follow the normal MAGTF chain-of-command relationship. All Marine forces, including aviation assets, come under the command of the Marine Corps component commander. To facilitate operations, the JFC may also establish a support relationship between Service components. In this case, the Marine Corps component commander may provide aviation assets in a support relationship such as general or direct support.

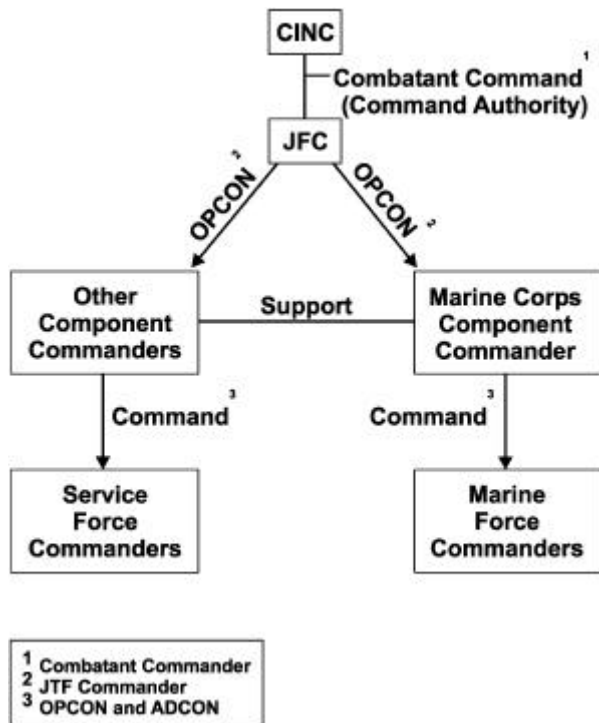

Figure 4-2. Joint Operations Conducted Through Service Components.

## b. Functional Components

A JFC may also conduct operations through functional components and/or employ them to coordinate selected functions. Functional components can be appropriate when forces from two or more military departments must operate in the same dimension or medium or the assigned mission breaks down into distinct functional aspects.

Clear command relationships must be established when the JFC centralizes direction and control of certain functions or types of joint operations under functional component commanders. In joint operations, each Service has its own aviation element and the JFC may appoint a joint force air component commander (JFACC) (see JP 3-56.1 for a detailed discussion on the JFACC). The JFC may, because of the interrelationship of the functions, choose to assign the responsibilities of JFACC, area air defense commander (AADC), and airspace control authority (ACA) to the same person, but not always. The JFC establishes command relationships that will most effectively accomplish the campaign plan's objectives.

The JFC must designate the military capability that will be made available for tasking by the functional component commander and the appropriate command relationship(s) that the functional component commander will exercise. For example, a JFACC is normally delegated TACON of the sorties or other available military capabilities. The command and control of Marine Corps aviation is specifically covered by Joint Pub 0-2 (see below). The MAGTF commander will make available to the JFC, for tasking through the JFACC, sorties in excess of MAGTF direct support requirements.

The MAGTF commander will retain operational control of organic air assets. The primary mission of the MAGTF air combat element is the support of the MAGTF ground element. During joint operations, the MAGTF air assets will normally be in support of the MAGTF mission. The MAGTF commander will make sorties available to the joint force commander, for tasking through the joint force air component commander, for air defense, long-range interdiction, and long-range reconnaissance. Sorties in excess of MAGTF direct support requirement will be provided to the joint force commander for tasking through the joint force air component commander for the support of other components of the joint force or the joint force as a whole. Nothing herein shall infringe on the authority of the geographic combatant or joint force commander in the exercise of operational control to assign missions, redirect efforts (e.g., the reapportionment and/or reallocation of any Marine Air-Ground Task Force (MAGTF) TACAIR sorties when it has been determined by the joint force commander that they are required for higher priority missions), and direct coordination among the subordinate commanders to ensure unity of effort in accomplishment of the overall mission, or to maintain integrity of the force.<sup>5</sup>

—Joint Pub 0-2, *Unified Action Armed Forces (UNAFF)*

*Note: Sorties provided for air defense (DCA), long-range interdiction and air reconnaissance, and EW are not “excess” sorties. These sorties provide a distinct contribution to the overall joint force effort and will be covered in the ATO. The JFC must exercise integrated control of air defense, long-range reconnaissance, and interdiction aspects of the joint operation or theater campaign.*

The Marine Corps component commander retains command of those Marine Corps forces and capabilities not designated by the JFC for tasking by functional component commanders. The JFACC will normally not have TACON of Marine aviation units, but will have TACON of Marine aviation sorties provided to the JFC for tasking. The Marine Corps component commander advises functional component commanders on the most effective use of Marine Corps aviation sorties that are made available. Marine aviation sorties are then designated as under TACON of the functional component commander for operational matters. All Marine Corps forces respond to the Marine Corps component commander for administrative and logistic support. The JFC may also establish a

support relationship between components to facilitate operations (see fig. 4-3).

Forward-deployed naval forces (including Marine Corps forces) are usually the first conventional forces to arrive in an austere theater or area of operations during expeditionary operations. The Marine Corps component commander’s inherent capability to command and control Marine Corps forces (and attached or assigned forces of other Services or nations) allows command and control of a functional component. The Marine Corps component commander may serve as a functional component commander. The JFC can designate the Marine Corps component commander as the joint force maritime component commander (JFMCC), joint force land component commander (JFLCC), or JFACC. If the Marine Corps component commander is assigned as the JFACC, the command and control agency (the joint air operations center [JAOC]) is provided by the MACCS. Figure 4-4 shows the command relations for a JFACC.

### 4004. Other Command Authorities

Administrative control (ADCON) is the direction or exercise of authority over subordinate or other organizations in respect to administration and support. It includes the organization of Service forces, control of resources and equipment,

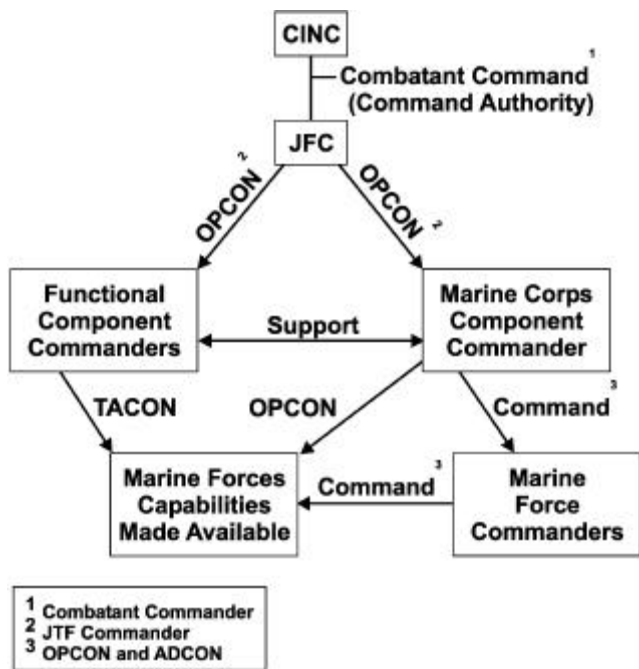

Figure 4-3. Joint Operations Conducted Through Functional Components

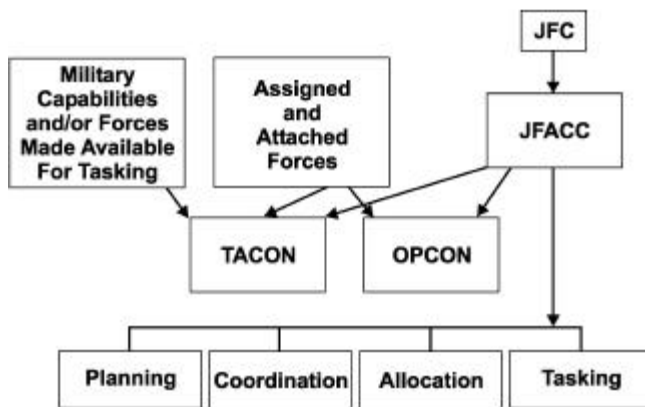

Figure 4-4. Command Relations for Joint Force Air Component Commander.

readiness, mobilization, personnel management, unit logistics, individual and unit training, demobilization, discipline, and any other matters not included in the operational missions of subordinate or other organizations. ADCON normally occurs in conjunction with OPCON. However, a specialized aviation unit could be separated from its parent unit for a significant amount of time, thereby requiring that ADCON be given to another headquarters.

### 4005. The Marine Air Command and Control System

The MACCS consists of various air command and control agencies that provide the ACE commander with the ability to monitor, supervise, and influence the application of Marine aviation’s six functions (see fig. 4-5). The ACE commander uses the MACCS to plan and direct ACE operations and to employ aviation assets in a responsive, timely, and effective manner. The MACCS provides facilities to control aircraft and missiles as well as to establish links with joint, multinational, other Services, and civil air command and control systems. Another function of the MACCS is to advise the MAGTF commander and JFC on

the application and employment of Marine aviation. The design of the MACCS allows the ACE commander to conduct centralized planning and optimize the use of limited resources. At the same time, the MACCS allows the subordinate commanders of the ACE to execute the plan in a decentralized manner. The MACCS provides the capability to conduct airspace command and control and deconflict aviation assets through centralized planning of airspace control procedures. It exercises air direction and decentralized execution of the airspace control plan through its subordinate agencies.

#### a. Air Direction

Air direction is a form of aircraft control used by the MACCS. It is the authority to regulate the employment of air resources by balancing an air resource’s availability against its assigned priorities and missions.

#### b. Air Control

Air control is a form of aircraft control used by the MACCS. Air control is the authority to direct the physical maneuver of aircraft in flight or to direct an aircraft or surface-to-air weapons unit to engage a specific target. Air control is composed of airspace control and terminal control. Airspace control directs the maneuver of aircraft to use the available airspace effectively. It is made up of positive control and procedural control. Terminal control directs the delivery of ordnance, cargo, or personnel by aircraft to a specific geographic location or target. MCWP 3-25.3, *Marine Air Command and Control System Handbook*, contains detailed discussions and definitions on the various forms of aircraft control.

#### c. Airspace Management

Airspace management is distinct from airspace control. Airspace management is the coordination, integration, and regulation of airspace usage in a defined dimension that results in the optimal use of available space. The MACCS uses effective airspace management to maximize freedom of use within the airspace while remaining consistent with the level of operational risk that is acceptable to the commander.

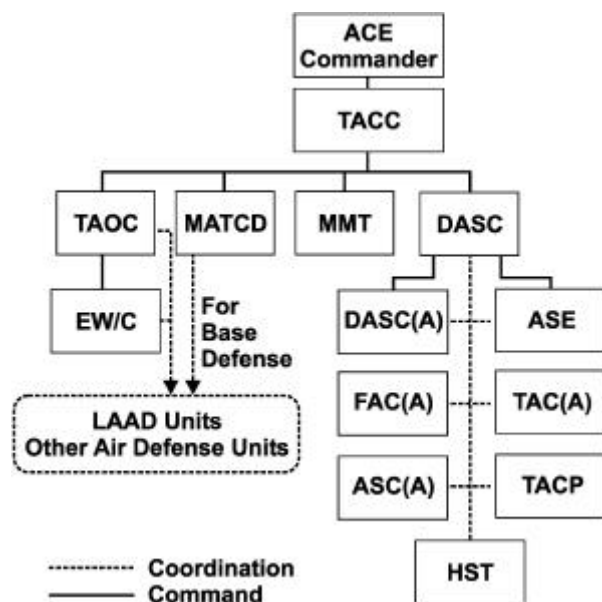

Figure 4-5. Marine Air Command and Control System Organization.

#### d. Marine Air Control Group

The MACG establishes, operates, and maintains the MACCS. The MACG contains subordinate units that provide the major agencies of the MACCS (see fig. 4-6). MEU support is provided to the ACE through task-organized MACG detachments. These detachments typically consist of a MASS, a MACS, a LAAD Stinger Section, and a MWCS. The MACG normally consists of the following:

- ┆ MACG headquarters.
- ┆ MTACS.
- ┆ MASS.
- ┆ MACS.
- ┆ LAAD battalion.
- ┆ MWCS.
- ┆ VMU.

#### e. Tactical Air Command Center

The principal air command agency for the ACE is the TACC. It provides the command post from which the ACE commander and staff plan, supervise, coordinate, and execute all current and future MAGTF air operations, including deep operations. The TACC integrates these functions with the MAGTF command element through linkage with the MAGTF FFCC and combat opera-

tions center (COC). The TACC is operated and maintained by personnel from the MTACS, with augmentation from the ACE staff and the MACG.

Although the TACC is primarily a command facility, it will also control the execution of deep operations from the deep battle cell in current operations. It provides the capabilities necessary to integrate, coordinate, and direct air operations in support of the MAGTF. The TACC interfaces with the other ACE command and control agencies, other MAGTF elements, and external civil and military air control organizations. Its primary interface with the MAGTF command element is through the force fires coordination center (FFCC) at the MEF level and the FSCC at levels below the MEF. The TACC's primary external interfaces are with the U.S. Army's tactical operations center (TOC), the U.S. Navy's tactical air control center (also called the TACC), and the U.S. Air Force's airfield operations center (AOC). If another Service component commander has been designated as the JFACC, then that commander's respective operations center will become the joint air operations center (JAOC). At that time, the JAOC becomes the TACC's primary external interface. In addition to serving as the ACE command post, the TACC provides the capabilities necessary for the ACE commander to serve as the JFACC, at which time the TACC will become the JAOC. Detailed information on the TACC can be found in MCWP 3-25.4, *Tactical Air Command Center Handbook*.

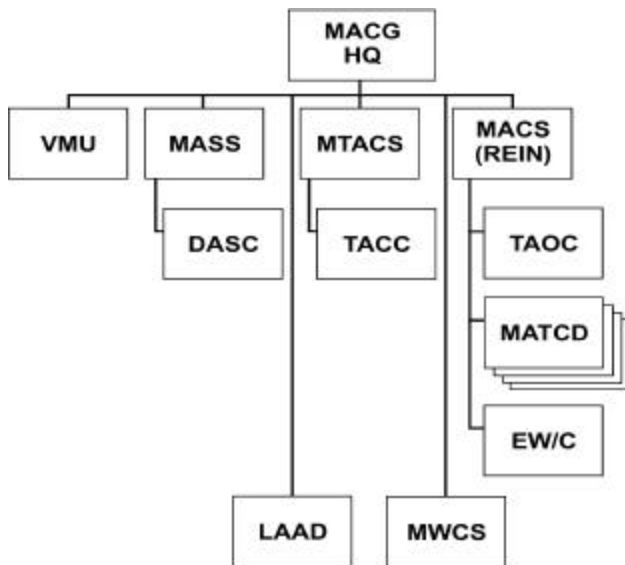

Figure 4-6. Notional Marine Air Control Group Organization.

#### f. Direct Air Support Center

The DASC is the principal MACCS air control agency responsible for the direction of air operations directly supporting ground forces. It processes and coordinates requests for immediate air support and coordinates air missions requiring integration with ground forces and other supporting arms. The DASC is usually the first principal MACCS agency ashore. It functions in a decentralized mode, but is subordinate to and directly supervised by the TACC. MCWP 3-25.5, *Direct Air Support Center Handbook*, contains detailed information on the DASC.

The DASC is established by the MASS and processes immediate requests for air support, coordinates aircraft employment with other supporting arms, and manages terminal control assets such as FAC(A) and assault support coordinator (airborne) (ASC[A]) in the support of ground forces. It will provide procedural control of assigned aircraft, UAVs, and itinerant aircraft transiting through its assigned area. The DASC can employ a DASC(A) aboard a KC-130 that will provide extended line of sight communications with low flying aircraft. In amphibious operations, the DASC normally lands in the same scheduled or on-call wave as the senior FSCC phased ashore.

The DASC will normally be collocated or electronically linked with the senior FSCC within the GCE. In a MEF operation that consists of multiple maneuver elements (divisions) within the GCE, the MEF commander may assume the role of GCE commander and require the MEF FFCC to also function as the senior FSCC of the GCE. In this instance, the DASC may be located with the MEF FFCC or the senior GCE FSCC in order to centralize management of CAS and assault support between the GCE maneuver elements (divisions) and to support the MAGTF commander's intent. DASC support of a multi-division GCE requires the assets and personnel from more than one MASS. In the multi-division GCE, there will be a DASC employed at the senior FSCC of the GCE and a DASC or air support element (ASE) for each division's FSCC. The circumstances that may require an ASE to be employed at the division level will be dictated by operational necessity, although ASEs are normally only employed with a MEU. These subordinate DASCs or ASEs provide the necessary links to the MACCS in order to request and coordinate direct air support. The size and composition of each DASC and ASE varies and can be expanded or reduced as the current situation requires and assets are available. Only the DASC and ASE have the capability to provide procedural control for aircraft operating in its area of responsibility.

The DASC has several employment options available, including an airborne configuration in a KC-130. MASS assets are tailored to provide support

based on the mission. A MEF could require a task organization that uses the assets of more than one MASS. At the MEU level, a MASS detachment would be task-organized as an ASE and would have a reduced capability due to its size. The size and capability of the MEF's DASC depends on the number of units that will be requesting air support and the number of aircraft executing air support missions. The DASC maintains communications connectivity with the other MACCS agencies, the FSCC, the FFCC, aircraft under its control, and joint and other Services' air support organizations. The DASC also requires connectivity with forward-based air assets to request a launch in support of ground forces.

The DASC operates through several air control organizations (see MCWP 3-25.3 for detailed information). These air control organizations are discussed in the following subparagraphs.

**(1) Tactical Air Control Party.** A tactical air control party (TACP) is a subordinate operational component of a tactical air control system. It provides air liaison to land forces and provides for the control of aircraft. In the Marine Corps, TACPs are organic to infantry divisions, regiments, and battalions. TACPs establish and maintain facilities for liaison and communications between parent units and airspace control agencies, inform and advise the ground unit commander on the employment of supporting aircraft, and request and control air support. The TACP is an agency of the MACCS, but administratively it is not part of the MACG. It is located within the GCE and provides ground commanders with the means to access direct air support.

**(2) Tactical Air Coordinator (Airborne).** A TAC(A) is an officer who coordinates, from an aircraft, the action of combat aircraft engaged in close support of ground or sea forces. Within the MACCS, the TAC(A) is a naval aviator and/or naval flight officer. The TAC(A) is the senior air coordinator and has air authority over all aircraft operating in an assigned area. The TAC(A)'s primary mission is to act as an airborne extension of the DASC, TACC, and/or FSCC. The TAC(A) contributes to coordination among TACPs,

FAC(A)s, and the fire direction of artillery and naval gunfire.

**(3) Forward Air Controller (Airborne).** A FAC(A) is a specifically trained and qualified aviation officer who exercises control from the air of aircraft engaged in close air support of ground troops. The FAC(A) is normally an airborne extension of the TACP. Within the Marine Corps, the FAC(A) is a naval aviator and/or naval flight officer who is specifically trained, qualified, and designated to perform air reconnaissance and surveillance, conduct terminal control of aircraft engaged in OAS operations, control artillery and naval surface fire support missions, act as a radio relay, and control landing zone preparations.

**(4) Assault Support Coordinator (Airborne).** An ASC(A) is an aviator who coordinates, from an aircraft, the movement of aviation assets during assault support operations. The ASC(A) is an experienced aviator with extensive knowledge of the MACCS who acts as an airborne extension of the DASC. This individual assists in providing situational awareness to the assault force, relays requests to the DASC, exercises launch authority for immediate and on-call missions, coordinates with the TAC(A), and provides routing recommendations to the air mission commander.

**(5) Helicopter Support Team.** A helicopter support team (HST) is a task organization formed and equipped for employment in a landing zone to facilitate the landing and movement of helicopter-borne troops, equipment, and supplies, and to evacuate selected casualties and enemy prisoners of war. Within the Marine Corps, HSTs are sourced from the force service support group (FSSG), specifically, the landing support company of the support battalion.

## g. Tactical Air Operations Center

The TAOC is responsible for airspace control and management. It provides the ACE with real-time surveillance of assigned airspace; the capability to detect, identify, and control the interception of hostile aircraft and missiles; and the direction,

positive control, and navigational assistance for friendly aircraft. The TAOC collects and displays information from its own sensors, other Marine Corps sources, and external sources that can be used to enhance the ability of the TACC to prosecute the ACE's support of deep operations.

Although collocated with the TAOC, the SAAWC is not an air command and control agency. He serves as an extension of the TACC, focusing on air defense planning and management. The SAAWC is the MAGTF's air defense battle manager. The SAAWC manages and coordinates all active defense weapons within an assigned sector, plans air defense operations, manages air defense resources, supervises the employment of air defense assets, and coordinates with higher and adjacent air agencies and activities.

The MACS provides the equipment and personnel need to operate the TAOC. MACS personnel assigned to the TAOC use specialized information systems, sensors, and dedicated communications links to search the MEF's airspace and to coordinate air defense. The TAOC controls friendly aircraft in the interception of hostile aircraft and assists missile units in locating and destroying hostile aircraft. Information gained through radar assets and tactical digital information links is transmitted to the TACC to update the air picture for the ACE commander. The TAOC also interfaces with the Air Force air operations center and its control and reporting center to coordinate joint air defense efforts.

The TAOC is movable, but not mobile. It is located in the rear of the MEF area of operations. The TAOC, with its organic sensors, is located to best facilitate surveillance coverage of the MAGTF sector. A MEF will normally deploy with one reinforced MACS that is task-organized to operate and maintain the TAOC. Normally, a MEU has no requirement for a TAOC, but an early warning and control capability may be task-organized as part of a SPMAGTF if required. For additional MACS information, see MCWP 3-25.6, *Marine Sector Antiair Warfare Coordinator Handbook*, and MCWP 3-25.7, *Tactical Air Operations Center Handbook*.

## **h. Marine Air Traffic Control Detachments**

The MATCD is the primary terminal ATC organization within the MACCS. It is organized and equipped to satisfy the ATC requirements for EAFs and FOBs. The detachment provides airspace control, management, and surveillance for its designated sector or area of responsibility. MATCD services include all-weather radar approach and departure control, en route ATC services within assigned controlled airspace, precision and instrument approaches, control tower operations, and tactical air navigation. Additionally, the MATCD contributes to the overall air surveillance effort. It coordinates air defense activities within designated base defense zones by assisting in the detection of hostile aircraft for LAAD Stinger teams assigned to airbase defense. The detachment serves as the MAGTF's liaison with host-nation, national, and international civil ATC agencies.

ATC detachments are components of the MACS. The MACS usually has four ATC detachments. All four detachments would be required to support a MEF operation in which four EAFs and up to four other air facilities or sites could be established. Large radar systems, support equipment, and shelters are used to provide MEF-level support. Deployment options include a mobile team capability. The mobile team is task-organized to provide an initial rapid response capability for the establishment and control of tactical landing zones. At the MEU level, the MACG detachment contains a task-organized MATCD mobile team. More detailed information on the MATCD can be found in MCWP 3-25.8, *Marine Air Traffic Control Detachment Handbook*.

## **i. Low Altitude Air Defense**

The LAAD battalion provides close-in, low-altitude, surface-to-air weapons fires in defense of forward combat elements, vital areas, and installations. It also provides surface-to-air weapons support for units engaged in special or independent operations. The battalion uses man-portable

Stinger missiles and a pedestal-mounted vehicular version (Avenger) that furnishes a shoot-on-the-move capability. LAAD units provide early warning to other elements of the MACCS through appropriate communications nets.

The LAAD battalion establishes a COC from which the battalion commander exercises overall command and control of battalion operations. The LAAD battalion COC is usually collocated with the SAAWC facility at the TAOC to receive cueing and increase situational awareness. The battalion comprises two batteries, with three platoons per battery and three sections per platoon. A section, which is the smallest employable LAAD element, has five Stinger teams. These may employ either the man-portable Stinger or the vehicle-mounted Avenger system. A MEF is normally supported by the entire battalion and a MEU is normally supported by one reinforced section. LAAD units are routinely task-organized to support various contingencies.

When the LAAD operates in general support of the MAGTF, its collocation with the TAOC is desirable to facilitate integration into the overall MEF air defense effort and to provide access to the air defense picture. When the LAAD operates in direct support of the GCE, its collocation with the DASC is a more effective location to receive the air defense picture and cueing from MACCS sensors. When information from other MACCS sensors is not available, the section employs a lightweight, short-range organic radar to detect aircraft and cue Stinger teams.

The LAAD battalion provides the MAGTF's only organic surface-to-air defense. Marine Corps forces have no organic means of ground-launched medium- or high-altitude air defense or theater missile defense, which was formerly provided by the Hawk missile system. The MAGTF depends on naval or another Services support to provide those requirements. More detailed information on the LAAD battalion can be found in MCWP 3.25.10, *Low Altitude Air Defense Handbook*.



## **j. Marine Wing Communications Squadron**

The MWCS provides communications for the ACE. It is not an agency of the MACCS, but the MWCS provides the backbone for ACE communications. It is responsible for the installation, maintenance, and operation of two distinct communications structures. These communications structures provide the ACE commander with the means to direct the efforts of subordinate commanders and provide connectivity among the sub-elements of the MACCS.

The MWCS installs, operates, and maintains expeditionary communications for the ACE, including the phased deployment of task-organized

elements. It provides digital backbone communications support; tactical automated switching and telephone services; electronic message distribution; single-channel radio communications; and WAN, deployed LAN, and server support. The headquarters and one detachment normally deploy and collocate with the ACE headquarters. When required, personnel and equipment from operational platoons are used to support the integration of MACCS agencies as well as support the ACE headquarters. At the MEU level, the MACG detachment consists of a task-organized MWCS communications team. More detailed information on the MWCS can be found in MCWP 3-25.9, *Marine Air Command and Control Systems Communications Handbook*.

## Chapter 5

# Aviation Planning

*“A good plan violently executed now is better than a perfect plan next week.”<sup>6</sup>*

—Gen George S. Patton, Jr.

Planning is a continuous, anticipatory, interactive, and cyclic process. There are many planning cycles that take place within the context of the force commander’s overall planning, decision, execution and assessment (PDE&A) cycle. Some of the cycles that relate to aviation planning are shown in figure 5-1. However, these planning cycles are not conducted separately, but collectively, and often simultaneously. They are inevitably linked together, with the inputs and outputs of each cycle interacting with other cycles on a continuous basis. All of these processes support the overall goal of producing a plan—a vital tool used to prosecute a campaign.

The process of planning is of utmost importance because it drives operations. Planning cannot be done *to* or *for* an organization; it must be done *by* it. Any commander or organization affected by a plan should have the opportunity to contribute to the planning process. This provides users an understanding of how and why the plan was constructed and provides an opportunity to affect how the commander will accomplish the assigned mission.

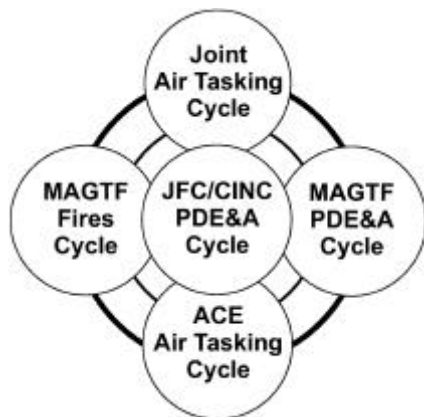

Figure 5-1. Linked Planning Cycles.

There are two major aspects of aviation planning: support of the operation plan (OPLAN) and/or fragmentary order (FRAGO) development and production of a daily ATO. Both allocate aviation assets, munitions, and support. Marine Corps operations and their requisite OPLANs are mission focused, intent driven, and event and/or condition based. ATO production is a continuous cycle based on assets and time. Aviation planning is the translation of the MAGTF commander’s event-and/or condition-based plan into a time-based plan of action for the ACE.

This chapter describes the ways in which aviation planning reflects and interacts with other cycles and planning concepts to produce the force’s overall operation order. It addresses the cyclical process that produces the ATO or air plan. MCWP 5-11.1, *MAGTF Aviation Planning*, contains a detailed discussion on all aspects of aviation planning, which culminate into an ATO or air plan.

### 5001. The Commander’s Role in Planning

The commander—whether the JFC, amphibious task force (ATF) commander, or MAGTF commander—is responsible for providing top-down planning guidance. Detailed aviation planning must embody the supported commander’s overall intent and concept of operations. The ACE commander is the MAGTF commander’s chief aviation expert and advisor and must simultaneously participate in the aviation planning process at three levels: within the ACE, within the MAGTF command element, and at the naval or joint force

headquarters (if any). The ACE commander directs the ACE staff in the execution of the aviation planning process. The ACE commander's inputs are key to the development of Marine aviation planning documents. The ACE battlestaff assists the ACE commander in executing duties by providing specialized expertise and advice. The ACE battlestaff (see fig. 5-2) consists of the chief of staff, the principal staff officers (i.e., G-1, G-2, G-3, G-4, G-6, and aviation logistics division [ALD] representative), and special staff officers (e.g., staff judge advocate, surgeon, chaplain) required by the situation or the ACE commander. The ACE commander's responsibilities include—

- 1 Acting as the MAGTF commander's principal Marine aviation advisor.
- 1 Advising and assisting the MAGTF commander and staff in developing the overall concept for the employment of aviation in support of the MAGTF.
- 1 Coordinating air operations with the GCE and the CSSE.
- 1 Coordinating with the naval expeditionary force and joint task force as necessary.
- 1 Developing the MAGTF ATO or air plan and/or Marine input to the joint ATO through the air tasking cycle.

## 5002. Staff Organization for Aviation Planning

From the TACC, the ACE commander conducts future operations planning and current operations monitoring. Each Marine aviation function (OAS, AAW, assault support, air reconnaissance, EW, and control of aircraft and missiles) has representatives in the TACC. The future operations section produces the air plan, ATO, or Marine input to the joint ATO. The current operations section manages the execution of the air plan or ATO. The G-3 or a senior G-3 representative serves as the senior watch officer within the current operations section. Key inputs to overall aviation planning are developed by the relevant organizations.

The TACC is organized as a fully integrated facility to promote the intra- and inter-staff coordination necessary for responsive and synchronized MAGTF air operations. The TACC enables the ACE staff to align functionally and organizationally with the MAGTF staff (see figs. 5-3 and 5-4). This facilitates inter-staff coordination, which is critical for effective planning and execution of MAGTF air operations. See MCWP 3-25.4 for detailed information on TACC organization and functioning.

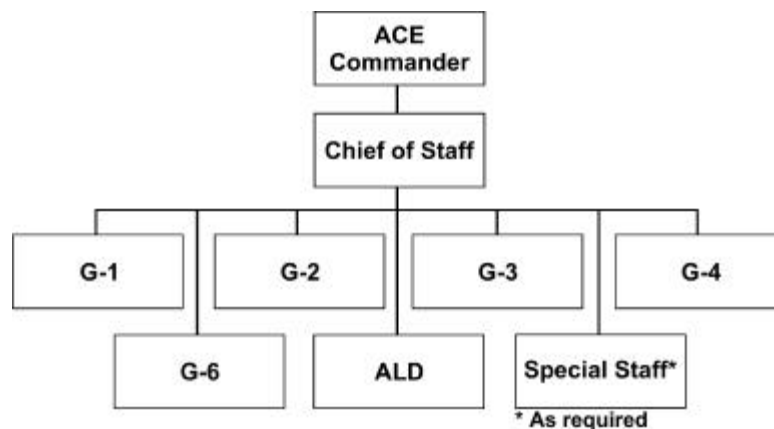

Figure 5-2. The ACE Battlestaff.

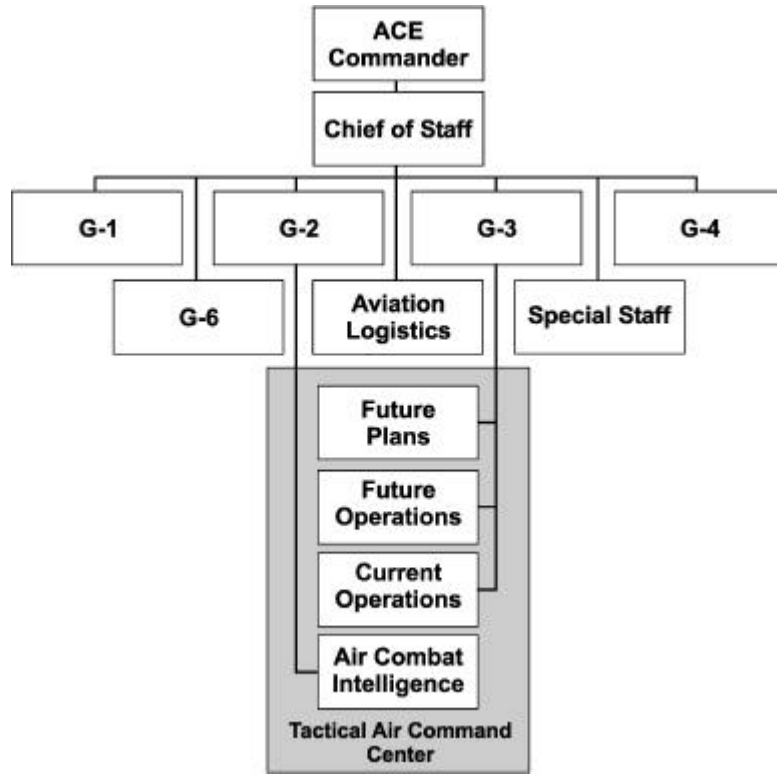

Figure 5-3. TACC Organizations and Command Relationships to the ACE Battlestaff.

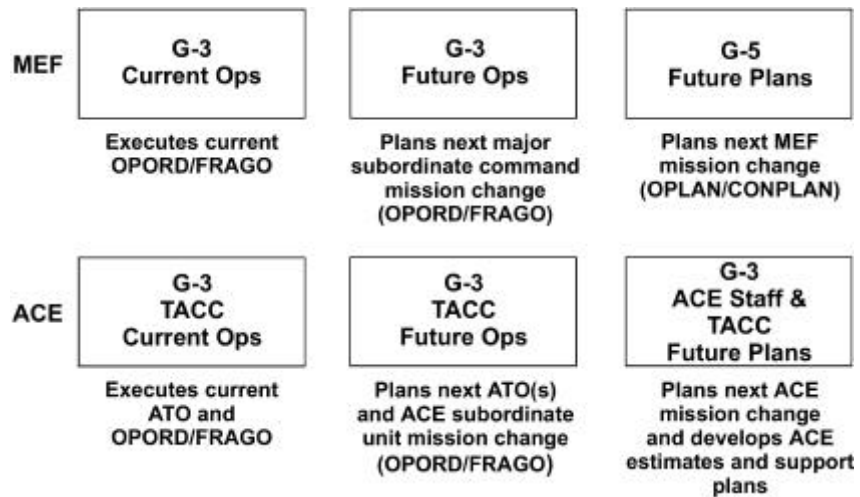

Figure 5-4. MEF-ACE Staff Alignment.

## 5003. Planning Cycles

All aviation planning takes place within the planning cycles of larger organizations: the JTF, the ATF, and the MAGTF. Planners at those levels will require inputs from aviation elements at each phase of their own planning, and their planning products will drive aviation planning. Moving from the general to the specific, key planning cycles and planning concepts include the following:

### a. The Planning, Decision, Execution, and Assessment Cycle

The commander and staff use the PDE&A cycle to plan operations, make accurate and timely decisions, direct the effective execution of operations, and assess the results of those operations. It is a series of continuous, interrelated processes that frame military operations.

The PDE&A cycle is a continuous cycle—from initial receipt of the mission through mission accomplishment. It is both time- and event-driven. It supports the commander's effort to assimilate information in the chaotic environment of war to increase tempo through timely and decisive action. For example, the ATO is critical to planning and executing operations and is produced in a cycle that requires timely input from subordinates. Planning the next operation also requires a constant flow of information from current operations.

### b. Integrated Planning Through the Warfighting Functions

The integrated approach to planning provides a functional approach that is systematic, coordinated, and thorough. It is based on the six warfighting functions: command and control, maneuver, fires, intelligence, logistics, and force protection. The warfighting functions encompass all activities in the battlespace.

Focusing on warfighting functions instead of specific arms or organizations allows the commander to fully integrate all actions into supporting the mission of the force as a whole. This helps the force achieve focus and unity of effort across all

organizational lines. For example, the GCE does not concern itself solely with maneuver, nor does the ACE concern itself solely with fires. Rather, each organization considers how it can contribute to each warfighting function in order to accomplish the force's overall mission. When all warfighting functions are focused to accomplish the desired strategic objective in the shortest time possible and with minimal casualties, the MAGTF can obtain maximum impact. The key to integrated planning within the command is the use of representatives for each warfighting function on the planning staff and between commands the warfighting functions are represented by liaison officers.

### c. The Marine Corps Planning Process

Within the PDE&A cycle, specific MAGTF operations and supporting aviation operations are planned by using the standard framework of mission, enemy, terrain and weather, troops and support available, time available (METT-T) and the cyclical, six-step Marine Corps Planning Process (MCP) (see fig. 5-5). MCWP 5-1 discusses the MCP in detail.

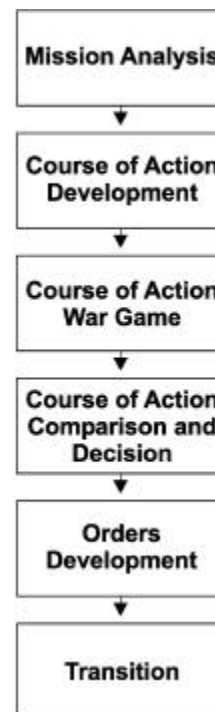

Figure 5-5. Marine Corps Planning Process.

The MCPP provides a logical and orderly method for planning operations. Each successive step in the process is linked. The output from one step becomes the input for the next. Interactions among various planning steps allow a concurrent, coordinated effort that maintains flexibility, makes efficient use of available time, and facilitates continuous information sharing. Aviation planning uses the MCPP and adjusts it as necessary to address the specific requirements associated with the planning and execution of air operations. By applying the MCPP to ACE planning, the tenets of the MCPP (single-battle concept, top-down planning and integrated planning) are also incorporated into ACE operations. The following subparagraphs provide a brief description of the six steps of the MCPP.

**(1) Mission Analysis.** Mission analysis is the first step in planning. The purpose of mission analysis is to review and analyze orders, guidance, and other information provided by higher headquarters and to produce a unit mission statement. Mission analysis drives the MCPP. The aviation commander will advise the commander on the aviation implications of the mission assigned.

**(2) Course of Action Development.** During COA development, planners use the mission statement (which includes higher headquarters' tasking and intent), commander's intent, and commander's planning guidance to develop several COAs. Each prospective COA is examined to ensure that it is suitable, feasible, different, acceptable, and complete with respect to the current and anticipated situation, the mission, and the commander's intent. In accordance with the commander's guidance, approved COAs are developed in greater detail. Each fully developed COA will include a concept of air employment.

**(3) Course of Action War Games.** During COA war games, each friendly COA is examined against selected threat COAs. This analysis involves a detailed assessment of each COA as it pertains to the threat and the environment. COA war games assist the planners in identifying strengths and weaknesses, associated risks, and asset shortfalls for each friendly COA. It is also

used to identify branches and potential sequels that may require additional planning. Short of actually executing the COA, COA war games provide the most reliable basis for understanding and improving each COA. For the war game of each COA, aviation planners must supply an estimate of supportability. The format for the aviation estimate of supportability can be found in MCRP 5-11.1A, *Aviation Planning Documents*.

**(4) Course of Action Comparison and Decision.** In COA comparison and decision, the commander evaluates all friendly COAs against established criteria. The COAs are then evaluated against each other. The commander selects the COA deemed most likely to accomplish the mission.

**(5) Orders Development.** During orders development, the staff takes the commander's COA decision, intent, and guidance and develops orders to direct the actions of the unit. Orders serve as the principal means by which the commander expresses his decision, intent, and guidance. Aviation planners produce an operations order and participate in the preparation of many other higher level orders.

**(6) Transition.** Transition is the orderly hand over of a plan or order as it is passed to those tasked with execution of the operation. It provides mission executors with the situational awareness and rationale for key decisions that are necessary to ensure a coherent shift from planning to execution. For aviation units, transition occurs at the aviation confirmation brief, during which the aviation plan is fully briefed to the commander, the staff, and key participants.

## 5004. Aviation Planning as an Element of MAGTF Planning

Aviation planning is conducted concurrently and in coordination with other MAGTF planning by using the steps of the MCPP and integrating the functions of aviation into the warfighting functions. While the MAGTF command element is planning overall MAGTF operations, the ACE

commander and staff are concurrently planning air operations in support of the MAGTF and coordinating with other elements of the MAGTF to determine their aviation support requirements. This concurrent, parallel approach to planning is possible through the use of mission-type orders, a clear understanding of the MAGTF commander's intent, and close and continuous liaison among the MAGTF command element, ACE, GCE, and CSSE and external organizations. Concurrent, parallel planning provides aviation planners with the time necessary to execute the air tasking cycle while enhancing the tempo of MAGTF operations. This form of planning also ensures that ACE operations are focused on attainment of MAGTF objectives in concert with the MAGTF commander's concept of operations.

### a. Aviation Planning and the Operation Order

Because aviation contributes to so many of the warfighting functions, aviation planners must provide input to the overall MAGTF operation order in many areas, including intelligence, operations, and logistic annexes. For example, the operations order, Annex C, contains an appendix on fire support that contains a tab on the air fire plan. MCWP 5-1 provides the full structure of an operation order. Details on the aviation operations annex can also be found in MCWP 5-11.1 and MCRP 5-11.1A.

Aviation planners produce numerous subordinate plans and documents, such as the airspace control plan (ACP) and the ATO. Annex W incorporates the aviation concept of operations (see MCWP 5-1 for an example) and may include any or all of the following appendixes (most of which include several subordinate tabs):

- ┆ Appendix 1, Air Defense/Anti-air Warfare.
- ┆ Appendix 2, Offensive Air Support.
- ┆ Appendix 3, Assault Support.
- ┆ Appendix 4, Reconnaissance and Surveillance Plan.
- ┆ Appendix 5, Supplementary Air Operations.
- ┆ Appendix 6, Aircraft Armament.
- ┆ Appendix 7, Air Control.
- ┆ Appendix 8, Air Communications.

- ┆ Appendix 9, Air Movement Plan/Flight Ferry.
- ┆ Appendix 10, Aircraft Schedules.
- ┆ Appendix 11, Air Tasking.

This information may be included in Appendix 17 (Aviation Operations) to Annex C (Operations) of the MAGTF operations order for smaller scale operations such as MEUs or (SP) MAGTFs.

### b. The Air Tasking Order

The JFACC or the ACE commander generates the ATO (MCRP 5-11.1A contains the ATO format). The ATO is used to task and disseminate to components, subordinate units, and command and control agencies the targets and specific missions of projected sorties, capabilities, and forces. It normally provides both general instructions and specific instructions, including call signs, targets, and controlling agencies (see JP 3-56.1). The ATO may include the airspace control order or the airspace control order may be issued separately. It also includes special instructions that provide amplifying notes, important details, and changes. The ATO, airspace control order, and special instructions provide operational and tactical direction at appropriate levels of detail. The level of detail should be very explicit when forces operate from different bases or when multi-component and/or composite missions are tasked. In contrast, less detail is required when missions are tasked to a single component or base. See JP 3-52, *Doctrine for Joint Airspace Control in a Combat Zone*, for further discussion.

Each ATO covers a 24-hour period. There are usually four ATOs at any given time. They include—

- ┆ The ATO undergoing assessment (yesterday's plan).
- ┆ The ATO in execution (today's plan), which is monitored by the current operations staff.
- ┆ The ATO in production (tomorrow's plan).
- ┆ The ATO in planning (the following day's plan) by the future operations staff.

Because input to the joint ATO must be provided 3 to 4 days in advance, the ATO can represent only a starting point for daily flight operations. It is impractical to predict every need in advance.

The MAGTF commander must have the flexibility to launch or to divert any aircraft as necessary to complete the mission, even if this requires short-notice deviations from the ATO.

In accordance with the character of maneuver warfare, the ATO must be flexible enough to change with the needs of the force as the situation changes. It is not a rigid constraint on operational flexibility. Because the ATO represents a great deal of necessary coordination and deconfliction of air assets and airspace, necessary deviations from the ATO should be well justified and relevant headquarters should be informed as quickly and as fully as possible. The JFC directs how changes are made to the ATO.

During Navy and Marine Corps operations afloat, an ATO may not exist, rather a consolidated flight schedule or ship's air plan is used. All squadron flight schedules are consolidated with the needs of the MAGTF, ship, amphibious ready group (ARG), or carrier battle group (CVBG) at an air board. The air board works on current and future plans for air support. The results are published as the ship, ARG, or CVBG air plan. The air board also provides the input for the joint ATO.

Most, if not all, missions involving squadron flight schedules and air plans will appear on the

joint ATO. This includes all MAGTF fixed-wing, rotary-wing, and UAV flights that operate within the JTF's airspace. This is necessary in order to coordinate airspace and minimize risk of fratricide. Those flights which may or may not be included in the joint ATO are usually routine helicopter functional check flights or ship-to-ship or ship-to-shore logistic flights. These routine flights have a negligent effect on airspace coordination and have been pre-approved and/or coordinated to be conducted on a regular basis.

Ships (particularly aircraft carriers) may also operate outside of the JTF's airspace. Missions that do not enter JTF airspace will not appear on the joint ATO. Nonetheless, every mission that is submitted and approved for the joint ATO must appear on squadron flight schedules and the MAGTF, ship, ARG, or CVBG air plan.

### 5005. The Air Tasking Cycle

The air tasking cycle (see fig. 5-6) is the key tool used by aviation planners to plan air operations that support the MAGTF's mission and produce the MAGTF ATO or air plan. The six-phase MAGTF air tasking cycle is compatible with the six-phase joint air tasking cycle. The six phases of

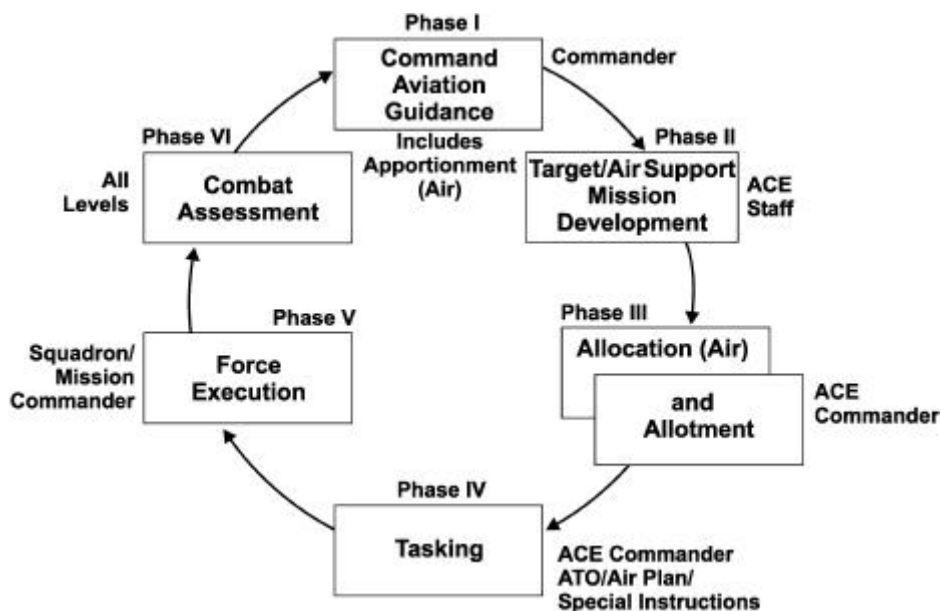

Figure 5-6. MAGTF Six-Phase Air Tasking Cycle.



the air tasking cycle are command aviation guidance, target/air support mission development, allocation and allotment, tasking, force execution, and combat assessment. JP 3-56.1 addresses the joint air tasking cycle. JP 3-09 and MCWP 3-42.1 address the targeting cycle.

### a. Command Aviation Guidance

The MAGTF air tasking cycle begins when the commander assigns a mission to the ACE commander. The MAGTF commander provides guidance through mission orders, clearly conveying the mission intent and designating the MAGTF main effort. In preparing this guidance, the MAGTF commander will normally consult with subordinate commanders to assess the results of the warfighting effort to date and to discuss future OPLANs. This provides subordinate commanders with an opportunity to introduce recommendations, describe their ability to support other elements, and list support requirements.

The commander's guidance and objectives identify targeting priorities, procedures, joint fire support coordinating measures, rules of engagement, and a definition of direct support sorties. The development of the concept of fires and targeting guidance is the responsibility of the MAGTF force fires coordinator and is based on the commander's intent and input from the major subordinate element commanders.

The MAGTF commander's uses the recommendations of the ACE commander and staff and the MAGTF force fires coordinator to make apportionment decisions. These decisions identify the total level of effort that should be dedicated to aviation tasks in order to accomplish the assigned mission. As the battle progresses, the MAGTF commander revises apportionment decisions to meet the requirements of the current situation. Apportionment is usually expressed as a percentage of the total aviation effort and helps to ensure the efficient use of limited aviation resources. If the MAGTF is part of a joint force, the MAGTF mission statement may include the JFC's apportionment guidance for Marine aviation if Marine sorties are to be provided to the joint force. The following is an example of the

MAGTF commander's apportionment for an amphibious assault operation:

#### Pre-Assault Operations

- | DAS, AAW, or SEAD sorties = 70% (a portion of these will go to the joint effort).
- | CAS sorties = 0%.
- | Assault support sorties = 10%.
- | EW sorties = 10%.
- | Command and control = 5%.
- | Excess sorties (any type) = 5% (will go to the joint effort).

#### During the Initial Assault

- | DAS, AAW, or SEAD sorties = 10% (a portion of these will go to the joint effort).
- | CAS sorties = 30%.
- | Assault support sorties = 45%.
- | EW sorties = 5%.
- | Command and control = 10%.
- | Excess sorties (any type) = 0% (there may be no excess sorties available).

*Note: Excess sorties are those sorties available for tasking, but are not needed by the MAGTF. Sorties provided for air defense, long-range interdiction, and long-range reconnaissance are not excess sorties and will be provided up front to the JFC as required. These sorties provide a distinct contribution to the overall joint force effort. The JFC must exercise integrated control of air defense, long-range reconnaissance, and interdiction aspects of the joint operation or theater campaign. Excess sorties are in addition to these sorties (see JP 3-56.1 for more details).*

### b. Target/Air Support Mission Development

The specific objectives described by the commander are used to focus specific target and air support mission development. All potential targets and air support requests are processed through the appropriate staff sections, which will identify, prioritize, and select specific targets/air support missions that meet the commander's objectives and guidance and support the concept of operations.

Overall target planning is the responsibility of the MAGTF force fires coordinator. The ACE commander and staff assist in this effort and provide essential guidance in the evaluation and selection of aviation targets. Targets are selected from joint target lists (if any), requests from all elements of the MAGTF, intelligence recommendations, EW inputs, and current intelligence assessments.

Air support mission development (including those missions involving the attack of targets) is also an essential component of this phase of the ATO development cycle. Air support mission requests are generated, evaluated, and prioritized in the same manner as targets. Since all of these missions require the allocation of ACE assets and those assets are usually finite, the ACE commander and staff play a central role in their evaluation. The MAGTF commander will ultimately approve the prioritization of both the target list and the air support mission list.

In accordance with the commander's objectives and component targeting/air support mission requirements, the ACE staff develops air OPLANs to employ all available and appropriate capabilities and forces. The end product of this phase of the ATO cycle is a MAGTF prioritized list of targets and air support missions.

### **c. Allocation and Allotment**

After receiving the commander's apportionment directive and understanding the targeting/air support mission requirements, the ACE commander allocates the planned effort. Allocation (air) is the translation of the air apportionment decision into the total numbers of sorties (by aircraft type) available for each operation or task. Allocation (air) includes the submission of all air support requests (OAS, DAS, AAW, assault support, and command and control) to the MAGTF FSCC and/or air center. When all air support requests have been received, the ACE commander presents the allocation request to the MAGTF commander. Once the allocation request has been approved, the allocated sorties are distributed, or allotted, to support the MAGTF and its elements. Allotment decisions allow MAGTF elements to plan and coordinate the integration of sorties into their fire

and maneuver efforts. The GCE and CSSE commanders determine the appropriate distribution of these sorties.

### **d. Tasking**

Tasking is the process of translating allocation and allotment decisions into an ATO or air plan and then passing the tasks to the units involved. The MAGTF ATO or air plan assigns missions and mission support responsibilities to specific squadrons.

If a Marine headquarters is designated as the ACA and/or JFACC, ATO interoperability with other Services depends to some degree on the Contingency Theater Automated Planning System (CTAPS). CTAPS is a hardware and software system composed of a variable number of workstations on a LAN that are linked with geographically remote terminals. The focus of CTAPS is the ATO that tasks operational units to fly specified combat and combat support missions and to maintain aircraft and aircrews at specified alert states. CTAPS functions are currently scheduled to be replaced by modules of the U.S. Air Force's Theater Battle Management Core Systems (TBMCS) program. TBMCS is an umbrella program that assimilates the ATO's production, dissemination and execution that currently resident in CTAPS. Additionally, TBMCS contains software modules that automate the DASC and theater missile defense planning functions. TBMCS is intended to resolve those problems of compatibility and interoperability associated with CTAPS. TBMCS links the organizational levels of command with automated tools as they relate to air operations, creating the functional capabilities for planning, intelligence, and operational execution. Ultimately, TBMCS will receive, display, and integrate a common space, air, ground, and maritime situation for all forces.

### **e. Force Execution**

Aircraft squadrons assign individual aircrews and aircraft to specific mission numbers and issue squadron flight schedules once they receive the ATO or air plan. Actual mission planning and coordination with the MAGTF command element,

ACE, GCE, and CSSE staffs are performed by the designated mission commander. Task-organized flights of aircraft then execute the assigned missions. During execution, the ACE commander exercises command and control of aviation forces through the MACCS, including the dynamic re-tasking of assets to meet the changing situation.

#### **f. Combat Assessment**

Effective campaign planning and execution require a continuing evaluation of the impact of combat operations on the overall campaign. Combat assessment is focused at the MAGTF level; however, it is done (in varying degrees) at all levels. Normally, the ACE G-3/S-3, assisted by the G-2/S-2, is responsible for coordinating combat assessment of ACE missions. The G-3/S-3's assessment is forwarded to the MAGTF staff for further evaluation.

Combat assessment evaluates a combat operation's effectiveness in achieving command objectives. The ACE staff continually evaluates the results of air operations and provides these evaluations to the MAGTF commander for consolida-

tion and overall evaluation of current operations. Combat assessment assesses the effects, relative to friendly objectives and strategy, of both specific air support missions and air operations in general against the specific targets attacked, whole target systems, and remaining enemy warfighting capabilities. It should include BDA, munitions effects assessment, and reattack recommendations. It must take into consideration the capabilities, forces, munitions, and attack timing employed.

Assessors should weigh future enemy COAs and remaining enemy combat capabilities against established targeting/air support mission priorities to determine future objectives and reattack recommendations. The ACE staff assessment is forwarded to the force commander to determine overall mission success and to recommend changes regarding COAs. Combat assessment marks the end of the air tasking cycle, but it also provides the inputs for the next air tasking cycle and subsequent command guidance, target/air support mission development, allocation and allotment, tasking, force execution, and combat assessment.

## Chapter 6

# Aviation Logistics

*“I don’t know what the hell this ‘logistics’ is that Marshall is always talking about, but I want some of it.”<sup>7</sup>*

—Adm Ernest J. King

ACE commanders and logisticians must plan and execute both aviation ground support operations conducted by the MWSS and aviation logistics operations conducted by the MALS. The MALS provides aviation-peculiar logistic support and the MWSS provides aviation ground support (EAF, aircraft rescue and fire fighting, etc.) as well as ground-common combat service support. A CSS detachment from the CSSE provides ground-common logistic support beyond the capability of ACE’s organic CSS units. These logistic operations must sustain the ACE, which in turn provides worldwide expeditionary support to the MAGTF. Direct support for naval aviation (Navy and Marine) is sourced and funded by the Navy, therefore components of the ACE use two sets of procedures for supply and maintenance operations: aviation logistic functions are prescribed by naval publications and aviation ground support logistic functions are prescribed by Marine Corps publications.

### **6001. Strategic Aviation Logistics and Aviation Ground Support**

Within the Marine Corps, the Deputy Chief of Staff for Aviation is responsible for planning and coordinating staff activities for all matters relative to the organization, equipment, manpower, training, and support of Marine Corps aviation units and installations, including all aviation logistic and/or aviation ground support matters. Since Marine Corps aviation is an integral part of naval aviation, the Deputy Chief of Staff for Aviation (a Marine Corps designation) is also designated as a OPNAV (N88M) (the Navy equivalent). This

makes the Marine Corps’ Deputy Chief of Staff for Aviation equal to the Navy’s Head, Air Warfare Division OPNAV (N88). In this capacity, the Deputy Chief of Staff is responsible to the Chief of Naval Operations to ensure that Marine Corps aviation is in consonance with the overall naval aviation program.

Within Headquarters Marine Corps the Department of Aviation, Aviation Logistics Support Branch is responsible for the equipping, supporting, and maintaining of aircraft and aviation units and installations across the logistic spectrum. The Aviation Logistics Support Branch coordinates with the Chief of Naval Operations (OPNAV) staff and numerous Naval Systems Commands to plan needed aviation logistic support of Marine Corps forces. Specifically, it plans the aviation logistic and aviation ground logistic support in matters of policy, management, procurement, supply, and distribution of materiel (including the acquisition, planning, programming, construction, management, maintenance, and disposition of real estate and facilities).

### **6002. Operational Aviation Logistics and Aviation Ground Support**

The MAGTF’s power-projection capability is based on its ability to move rapidly to and operate freely within an objective area anywhere in the world. To maintain this power-projection capability, the MAGTF requires responsive air support during all phases of its operations. To provide responsiveness in austere expeditionary environments, Marine aviation must consider basing

options and available logistic support. Marine aviation basing selections must consider versatility, capability, vulnerability, footprint, and sustainability regardless of whether it operates from the sea or from shore-based airfields located close to or in the area of operations.

### a. Seabasing

Aviation logistic operations from aircraft carriers, aviation-capable amphibious ships, and aviation logistics support ships (TAVBs) can eliminate the need to establish vulnerable, relatively immobile support facilities ashore. This reduces footprints ashore and translates into greater freedom of maneuver and operational flexibility and a lessened vulnerability for the ACE. Seabasing of Marine aviation also eliminates the political problems associated with obtaining host nation permission to use airfields and facilities. However, the operational situation may be such that the limited space and facilities aboard ship are overtaxed or the distance from the ship to the operating area is great. In those cases, aviation forces may require a FOB and retain as much of the aviation logistic support as possible at sea.

### b. Forward Operating Bases

When it is necessary to meet operational demands, the ACE can operate from shore-based, FOBs. A FOB is any airfield used to support tactical operations without establishing full support facilities ashore. FOBs include main air bases, air facilities, air sites, and air points. FOBs increase responsiveness by decreasing the distances between the aviation base and the supported unit. Whenever possible, shore-based ACE operations exploit existing facilities in the area of operations. Host government airfields are used when available and tactically acceptable. Abandoned or captured airfields are also used to reduce construction and infrastructure requirements. If existing airfields are not adequate or suitable, roads and highways may be used to provide austere runways. Finally, if facilities are inadequate or nonexistent, Navy and Marine units can be utilized to build an EAF. The MALS/MWSS uses task-organized support packages (see para. 6002c) to provide aviation logistics and aviation ground support for

FOBs. ATC support is provided by task-organized MATCD or mobile teams resident within the MACG or MACS (see chap. 4).

**(1) Expeditionary Airfields.** EAFs are portable airfields that can be constructed, used, dismantled, and moved to another site for reuse. They are constructed on-site by the MWSS and Navy mobile construction battalions. The EAF can be used to support the full range of FOBs, from small austere sites to large main bases. The EAF system is unique and flexible. It permits Marine aviation to operate from captured or damaged runways, parking lots, or roads and to establish bases where none previously existed. This flexibility allows the ACE to adjust to an ever-changing operational situation. The development of EAF technologies and the storage of these assets on maritime prepositioning force (MPF) ships have reduced the U.S. deployment time to any theater of operations in the world from 9 or 10 weeks to 2 or 3 weeks.

**(2) Forward Arming and Refueling Points.** Since existing air bases or air facilities may not exist in a dynamic, nonlinear battlespace, the ACE commander can deploy a FARP to provide the required aviation support. It is temporary and, it is established for a specific mission. A FARP is sometimes referred to as a laager point.

A FARP permits combat aircraft to rapidly and simultaneously refuel and rearm from a forward location. It provides the fuel and ammunition necessary for employment of aviation maneuver units in combat. To reduce response time and maximize aviation's capabilities, the FARP is positioned as close to the objective area as the tactical situation allows.

**(3) Austere Forward Operating Sites.** In some situations, particularly when operating in underdeveloped areas of the world, Marine aviation forces may be forced to use extremely austere sites as bases for aviation operations. Such sites possess a minimal ground support capability. They may be nothing more than a jungle clearing that is large and firm enough to support helicopter or V/STOL operations, or they may be a stretch of

highway that is sufficient to accommodate fixed-wing aircraft.

### **c. The Marine Aviation Logistics Support Program**

Navy-funded aircraft logistic support is provided under MALSP and administered and maintained by the MALS. MALSP, together with TAVB and assets prepositioned aboard MPF ships, provides the supporting MALS the ability to support either fixed-wing or rotary-wing aircraft of the ACE.

While the MEU ACE is embarked aboard an air-capable ship (e.g., LHA, LHD), aviation logistics is the responsibility of the aircraft intermediate maintenance department (AIMD) and the ship's supply department rather than the MALS. While Marine Corps aircraft squadrons operate from a carrier, they receive aviation logistic support from the AIMD and the carrier's supply department. Maintenance and supply personnel from both the MALS and Marine Corps aircraft squadrons augment the ship's AIMD and supply department.

MALSP provides flexible and effective aviation logistic support to the deployed MAGTF ACE. It enables ACE logisticians to rapidly and efficiently identify, marshal, and deploy aviation logistic elements needed to support a task-organized mix of ACE aircraft.

By structuring aviation logistic support into force modules, MALSP provides credible and replenishable sustainment packages while reducing lift requirements and force closure times. Required aviation logistic elements (personnel, spares, support equipment, and mobile facilities) are formed into specific support packages that are retained within every MALS. Specific support packages consist of fly-in support packages (FISPs), contingency support packages (CSPs), and follow-on support packages (FOSPs). They are sized and tailored to meet the aviation logistic requirements of each type, model, and series aircraft. These packages are used in a "building block" fashion to maintain aircraft availability during every phase of an operation.

FISPs are considered enabling packages. They provide the organizational-level spare parts (remove and replace) that allow Marine aircraft to begin flight operations immediately upon arrival in theater. FISPs are airlifted to the operating site as part of the fly-in echelon (FIE). When combined with aviation support equipment and class V(A) ammunition transported aboard MPF ships or flight ferry aircraft, FISPs provide the critical aviation support required for 30 days of combat flying. If flight operations are too extensive in scope or duration (i.e., longer than 30 days), the next building blocks, CSPs, are transported into theater. CSPs augment FISPs by adding the common and peculiar aviation logistics needed for sustained aviation maintenance, supply, and ordnance operations. CSPs integrate the support equipment, mobile facilities, spares, and personnel to sustain deployed aircraft for up to 90 days.

FOSPs are the final MALSP building block. A FOSP provides the support that the FISP and CSP do not provide. It provides ACE aircraft with the same support that it would receive in garrison and includes first degree engine repair.

Training squadron allowances are built to support a 30-day endurance period at peacetime flying hours. It consists of separate, aviation logistics support items added to the allowances of a garrison MAG. Training squadron allowance items are separate from contingency support packages so that during times of extended expeditionary operations, CONUS-based training squadrons will retain the necessary aviation logistic elements that will enable them to continue training operations.

### **d. Aviation Logistics Support Ship**

The TAVB's primary mission is to provide dedicated sealift for movement of I-level aviation logistic support for use in the rapid deployment of a MAGTF ACE. It is designed to transport critical I-level maintenance and supply assets to a forward operating area as part of a MEF-sized MAGTF contingency. The TAVB's primary concept of operations is to support MPF operations, but it can also be tasked to support an amphibious operation. Traditionally, an amphibious operation exerts a forcible entry into an objective area,

however a TAVB requires an unopposed entry into an objective area (similar to an entry required for a MPF) before offloading the MALS and its composited contingency support packages ashore. If the embarked MALS is phased ashore, the TAVB can be used to perform a secondary mission of serving as a strategic sealift asset that is controlled by the commander in chief.

To enhance MALS responsiveness, one ship (USS Wright, TAVB 3) is berthed on the east coast (Baltimore, MD) and another ship (USS Curtiss, TAVB 4) is berthed on the west coast (Port Hueneme, CA). On notification of movement, the TAVB is expected to arrive in the objective area within 30 days to marry with supported aircraft squadrons, personnel, and aviation logistic assets already in theater. Both ships can be configured to provide I-level support operations while underway, in stream, or pier-side. In consonance with the operational concept and if conditions permit, The MALS can be transferred ashore upon arrival.

### e. Maritime Prepositioning Force

Aircraft that are part of an ACE can be supported in combination by one, or more, of the three MPS squadrons. Each MPF squadron contains the following operational and logistic support assets: class V(A) munitions, O-level and limited I-level aircraft support equipment, EAF matting and airfield lighting, and ground common CSS assets for utilization by the supporting MWSS. These assets are required to support the notional MPF ACE aircraft mix as defined by MCBul 3501, *Maritime Prepositioning Force (MPF) Marine Air-Ground Task Force (MAGTF) Force List*. See MCWP 3.32, *MPF Operations*, for more information.

## 6003. Tactical Aviation Logistics and Aviation Ground Support

Logistic support for the ACE may be categorized as either aviation logistics, aviation ground support (e.g., EAF, aircraft rescue and fire fighting), or combat service support. Aviation ground support and combat service support are primarily

funded by the Marine Corps. Aviation logistics (aviation-peculiar) is primarily funded by the Navy. The following subparagraphs provide an overview of the unique tactical aspects of aviation logistic support of the ACE. See MCWP 3-21.1, *Aviation Ground Support*, and MCWP 3-21.2, *Aviation Logistics*, for an in-depth discussion of aviation ground support,

### a. Aviation-Peculiar Logistic Support

Each MALS is organized to provide a core group of supervisory and support personnel that, when augmented by aircraft-specific maintenance personnel from aircraft squadrons, provide an intermediate maintenance capability for either fixed-wing or rotary-wing aircraft. Aircraft squadrons are responsible for organizational-level maintenance. The following comprise the core capabilities of a MALS:

- 1 Provide intermediate-level (I-level) maintenance for aircraft and aeronautical equipment of all supported units, when authorized, perform first degree repair on specific engines.
- 1 Provide aviation supply support for aircraft and Navy-funded equipment to all supported units.
- 1 Provide class V(A) ammunition logistic support to ACE squadrons. This support encompasses the requisitioning, storage, handling, assembly, transportation, inventory reporting of class V(A) ammunition, and planning for and operating an ammunition issue point at expeditionary sites.
- 1 Interpret, implement, audit, inspect, and provide oversight for the MAG commanding officer for all policies and procedures relating to the administration and management of operations and maintenance, Navy (less TAD) funds, aviation supply, aircraft maintenance, cryogenics, aircraft ordnance, avionics, and data processing for all units within the MAG and the ACE.
- 1 Coordinate with the MWSG, MWSS, MACG, and other supporting Navy and Marine Corps activities in planning for the support required to execute aviation logistics.
- 1 Screen and inspect nonservicable aeronautical equipment and material for testing and repair, shipment to another repair facility, or disposal.

- 1 Maintain the capability to deploy and to provide MALSP packages as integral units or as tailored aviation logistic elements assigned to another MALS to support aircraft assigned to a host MAG, MALS, or ACE.
- 1 Conduct individual and unit training to qualify organic and supported squadron personnel for performance of assigned missions and tasks.
- 1 Provide data processing support to facilitate execution of aviation supply, maintenance, and Navy-funded financial functions of the MAG and ACE.

### **b. Aviation Ground Support**

The MWSS provides aviation ground support and CSS functions for airfield operations. Specific services include EAF, explosive ordnance disposal, weather services, military police support, engineering support, materials handling equipment, motor transportation, intra-airfield communication, aircraft rescue and fire fighting, utilities support and maintenance, field messing, medical support, and aircraft and ground vehicle refueling. The MWSS routinely performs the camp commandant functions and provides the nucleus for rear area security and air base defense. MWSSs are designed to support either fixed-wing or rotary-wing operations; however, a single MWSS can

be task-organized to simultaneously support fixed-wing and rotary-wing operations.

### **c. Combat Service Support Detachment**

A CSSD from the CSSE provides additional combat service support to the ACE. CSSD capabilities include—

- 1 Transporting fuel, ordnance, and other supplies required by the ACE from the point of entry in the MAGTF area of operations to the EAF site for distribution by a MWSS and/or MALS.
- 1 Performing third echelon maintenance on engineer, motor transport, and communications equipment that is supported by the Marine Corps and operated by the ACE.
- 1 Providing postal, disbursing, exchange, legal, civil affairs, and graves registration services.
- 1 Providing supply, general engineering, health services, and other support that cannot be satisfied by a MWSS.

CSSDs will be formed from the CSSE to provide the required support based on specific support requirements that are determined, requested, and coordinated by the ACE G-4/S-4.



## Chapter 7

# Marine Aviation in Navy, Joint, and Multinational Operations

*“When a team takes to the field, individual specialists come together to achieve a team win. . . .*

*But they all must also believe that they are part of a team, a joint team, that fights together to win.*

*This is our history, this is our tradition, this is our future.”<sup>8</sup>*

—Colin L. Powell

The Marine Corps’ most significant contribution to a Navy, joint, or multinational operation is the MAGTF. Marine aviation is normally committed as the MAGTF’s ACE, but individual units may also be assigned to support other operations. These units may function as an integral part of a Navy carrier force, or they may provide specific functions (e.g., EW) in general support of a JTF in joint or combined operations.

### 7001. Navy Fleet Operational Support

The primary mission of Marine aviation is to participate as the air component of the MAGTF in the seizure and defense of advanced naval bases and to conduct land operations that are essential for the prosecution of a naval campaign. A collateral mission for Marine aviation is to participate as an integral component of naval aviation in the execution of other Navy functions as fleet commanders direct. In this role, they normally become part of the Navy component of a joint force. In either case, Marine aviation assets are part of an integral force and are not normally separated from that force.

### 7002. Joint Operations

Joint operations are military actions conducted by joint forces or Service forces in relationships (e.g., support, coordinating authority) that of themselves do not create joint forces. Joint operations are conducted in support of the JFC’s campaign and the commander in chief’s theater campaign plan.

The MAGTF has a unique, self-contained air-ground capability. However, Marines must be prepared to become a self-sustaining, contributing part of joint operations ashore under the command of a JFC. A JFC synchronizes the actions of air, land, sea, space, and special operations forces to achieve strategic and operational objectives through integrated, joint campaigns and major operations. Their goal is to increase the total effectiveness of the joint force, not necessarily to involve all forces or to involve all forces equally.

The job of planning and tasking Marine aviation to support the MAGTF commander becomes more complex when operating in a joint environment. MAGTF planners and operators must understand the MAGTF planning and operating

environment, the joint planning and operating environment, and how the two interface (see chap. 4 for more information).

The JFC organizes forces to best accomplish the assigned mission: along Service lines conducting operations through Service component commanders, along functional lines (air, ground, etc.) conducting operations through functional component commanders, or a combination of the two approaches and assigning functional commands to the Service component that is best prepared to control each function. Examples of functional component commanders include the joint force air component commander (JFACC), joint force land component commander (JFLCC), and joint force maritime component commander (JFMCC). The JFC can also use other functional commanders, such as the AADC, joint special operations forces commander, and joint force information warfare commander.

Normally collocated with the JFC, the JFACC functions as a coordinator of the JTF's aviation resources to deliver direct support to certain components while exploiting the flexibility of air operations to achieve campaign objectives. The JFACC recommends apportionment of the joint air effort to the JFC for approval or revision and translates the JFC's apportionment decision into sortie allocation. The JFACC determines allocation by mission, but individual components assign missions to specific units. The JFACC is also responsible for tasking available component air sorties for support of the joint campaign, normally through the ATO. Tasking is done at the JFACC level for joint targets and missions and at the MAGTF level for Marine Corps targets and missions. There is a single ATO for all joint air operations.

The MAGTF's expeditionary nature, coupled with Marine aviation and its associated command and control capabilities, allows the Marine component commander to function as the JFACC in small-scale operations. The Marine component commander may also initially serve as the JFACC at the early stages of a larger conflict. As forces continue to build up in theater, the JFC normally designates the commander with the preponder-

ance of aviation assets and the ability to command and control all aviation assets as the JFACC.

In joint operations, the JFC normally tasks the MAGTF commander to provide certain types of sorties for tasking through the JFACC. But the MAGTF commander retains OPCON of all MAGTF ACE assets. This tasking normally includes sorties for air defense (DCA), long range air interdiction and air reconnaissance, and EW.

It is important to understand that the MAGTF commander will retain operational control of organic air assets (TACAIR) during joint operations. This entire policy is outlined in chapter 4, page 5, and described in more detail in JP 0-2, UNAAF. This policy will allow the MAGTF commander to meet the needs of the JFC while maintaining the tactical and operational integrity of the MAGTF component. Key to this arrangement is the premise outlined in JP 3-0, Doctrine for Joint Operations, which states: "The JFC (and CINCs) should allow Service tactical and operational groupings to function generally as they are designed." Further, JP 3-56.1 states that one of the most important aspects of this guidance is the requirement for an air capable component to "provide the JFACC a description of their direct support plan (DSP) to allow for coordination and deconfliction of targeting efforts between each component and the JFC staff and agencies."

The DSP is crucial in clarifying to the JFC at the outset of the joint campaign what the Commander Marine Corps Forces (COMMARFOR) requires to sustain Marine Corps operations in support of the joint campaign plan. It should comprise the following key elements as stated by the COMMARFOR:

- 1 His intent to retain OPCON of his aviation capability/forces;
- 1 That all Marine sorties should be made available to the JFC for tasking by the JFACC in support of the JFC's overall objectives and campaign plan prior to assignment of ground combat responsibilities since the MARFOR requires no direct support sorties or shaping operations during this period. This includes long range air interdiction and air reconnaissance,

electronic warfare and air defense (defensive counter air) sorties when required by the JFC;

- l His intent to use organic aviation assets in direct support of his forces in order to accomplish his JFC-assigned mission in the designated MARFOR area of operations (AO). Critical DSP sub elements to this are:
  - n His intent to consolidate, deconflict, prioritize and nominate targets to the joint targeting coordination board (JTCCB) to be included on the joint integrated prioritized targeting list (JIPTL).
  - n Provide a MAGTF generated direct support ATO to merge with the JTF joint ATO via CTAPS/TBMCS.
  - n Allocate sorties in excess of COMMARFOR's direct support requirements to the JFC for tasking by the JFACC for use in execution of joint operations.
  - n Recommend to the JFACC, if designated as the ACA/AADC, airspace control measures (ACM) that enhance integrated command and control in COMMARFOR's AO/areas of responsibility. This includes establishing the MACCS within the MARFOR's AO to provide airspace control functions in the MARFOR's airspace control sectors as designated by the ACA. These details must be incorporated in the air control plan (ACP) and coordinated with the ACA to ensure consistency with JTF airspace control guidance, directives and procedures. COMMARFOR will forward all ACM requests to the ACA via the MARFOR liaison team at the JFACC.

Normally, any sorties in excess of MAGTF direct support requirements are also made available to the JFC. The JFACC uses MAGTF sorties to support the JFC's campaign objectives, often through support to other components of the joint force. In turn, the MAGTF commander can also request aviation support from the JFC when organic Marine aviation assets do not meet the MAGTF's aviation requirements. See MCWP 3-25.4 and JP 3-56.1 for a discussion of the contingency theater automated planning system, which governs the development of the ATO.

*Note: Sorties provided for long-range interdiction, air defense, and long-range reconnaissance are not "excess" sorties. These sorties provide a distinct contribution to the overall joint force effort and will be covered in the ATO. The JFC must exercise integrated control of air defense, long-range reconnaissance, and interdiction aspects of the joint operation or theater campaign.*

### 7003. Multinational Operations

U.S. military operations are often conducted in cooperation with the armed forces of other nations in pursuit of common objectives. Multinational operations, both those that include combat and those that do not, are conducted within the structure of either an alliance or a coalition. An alliance is created by formal agreements among two or more nations in pursuit of broad, long-term objectives. Some alliances (e.g., NATO) have detailed interoperability arrangements, protocols, and procedures. A coalition is an temporary arrangement among two or more nations for a specific purpose. There is no universal doctrine for coalition warfare; protocols and operating agreements are designed to suit the circumstances. Technically, only alliance operations are combined operations, but in common usage the word "combined" is often used to describe any multinational operation.

Joint operations that are part of an alliance or coalition require close cooperation among all forces. Well-managed combined operations can serve to mutually reinforce strengths, reduce vulnerabilities, and provide legitimacy. Effectively planned and executed multinational operations should, in addition to achieving common objectives, facilitate unity of effort without diminishing U.S. freedom of action. Multinational operations should also preserve unit integrity and uninterrupted support.

Each multinational operation is unique. Planning and the conduct of operations vary with the international situation and the perspectives, motives, and values of the operations's members. Whereas alliance members typically have similar political

and economic systems and common long-term goals, coalitions often bring together very diverse elements and cultures for a limited period of time. Typically, if coalition members perceive their membership and participation to be advancing their individual interests, the coalition remains intact. If their objectives or priorities diverge, the coalition may break down. Therefore, military leaders of member nations must emphasize common objectives as well as mutual support. Following, contributing, and supporting are important roles in multinational operations, therefore, the MAGTF is prepared to operate within the frame-

work of an alliance or coalition that is led by a nation other than the United States.

The inherent flexibility of the Marine Corps' combined-arms doctrine, maneuver warfare philosophy, expeditionary nature, and versatile command and control system create a MAGTF that is well-prepared for the complexities of coalition warfare. Of great concern to the MAGTF, and to the ACE in particular, will be the problems of force protection, command and control of vastly dissimilar units, and the avoidance of fratricide.

## Chapter 8

# Emerging Concepts

*“In brief, the whole future of warfare appears to me to lie in the employment of mobile armies, relatively small but of high quality, and rendered distinctly more effective by the addition of aircraft . . . .”<sup>9</sup>*

—Gen. Hans von Seeckt

Operational maneuver from the sea (OMFTS) is both the operational foundation and the capstone of the Marine Corps’ concept of operations for the future. From this foundation flows supporting concepts such as ship-to-objective maneuver, sustained operations ashore, MPF 2010 and beyond, and the Marine aviation concept paper, *MAGTF Aviation and Operational Maneuver From the Sea*. These concepts define the Marine Corps’, and therefore Marine aviation’s, future role in terms of capabilities, operational employment, and joint relationships. These concepts also reflect the Marine Corps’ understanding of and commitment to maneuver warfare.

All of these concepts rely heavily on seabasing. The Marine Corps and the Navy currently conduct OMFTS and seabasing operations, but not to the degree outlined in recent concept papers. Although Marine aviation has a long tradition of ship-based operations, future, large-scale sea-based Marine aviation operations will be far more complex and demanding. If the Marine Corps and Navy are to conduct OMFTS as it is now envisioned, they will require substantial advances in aircraft, ships, command and control systems, and logistic capabilities, as well as organizational and doctrinal refinements to meet the proposed capabilities. This chapter explores the key new concepts and their implications for Marine aviation.

### **8001. Operational Maneuver From the Sea**

The Marine Corps’ capstone operational concept of OMFTS was published in January 1996. It was

built on the foundation provided in . . . *From the Sea*” and “*Forward . . . From the Sea*. This concept encompasses more than how Marines will conduct power projection operations in the 21st century, it is a naval concept developed by the Marine Corps and designed to be executed in concert with the Navy. OMFTS places unprecedented emphasis on operations in the world’s littorals, demands greater integration of naval operations in maneuver warfare, and capitalizes on a naval forces’ ability to use the sea as a maneuver space. It is, in fact, a marriage between maneuver warfare and naval warfare. The philosophy of maneuver warfare provides an understanding of the dynamic nature of military conflict and the requirement for skillful operations at a high tempo. The underlying ideas of naval warfare reflect the advantages inherent in seaborne movement and seabased logistics. OMFTS requires enhanced battlespace mobility, intelligence, command and control, fire support, and sustainment. It enables forward-deployed forces to provide the appropriate response to events throughout the range of military operations.

A key element in OMFTS is the seabasing of command and control, logistics, and most fire support functions. The seabasing of command and control greatly reduces the force’s vulnerability and footprint ashore. By reducing logistic requirements ashore and relying heavily on naval surface fires and aviation fires, ground forces are permitted greater mobility. Seabased fire support enhances and complements the effectiveness of ground-based fire support. Seabased forces enable commanders to providing CSS assets to fighting units without being distracted by the rear area security concerns inherent in shore-based logistic

operations. Seabasing thus allows the ATF to put the “teeth” ashore while leaving the support “tail” afloat, significantly enhancing the flexibility and tempo of land maneuver operations.

Marine aviation plays a vital part in OMFTS. From staging areas over the horizon, aviation will provide responsive and sustained fires and logistic support directly into objective areas ashore. The concept of seabased aviation is not a new one. Marines have used helicopters to resupply ground forces since fielding the helicopter in the early 1950's. ACE aircraft have always been based on and supported by the ships of the amphibious ready group. In OMFTS, however, ACE aircraft will depart from over the horizon, with the assault support forces embarked, and proceed to objective area landing zones deep inland. The main differences are the sizes of the assault forces to be lifted, the distances to be transited, and the magnitude of the operations to be executed. The MV-22 tilt-rotor will provide the speed, endurance, combat radius, payload, and survivability needed to permit true maneuver warfare from the sea on a scale that supports the OMFTS concept.

## **8002. Ship-to-Objective Maneuver**

OMFTS requires new tactical concepts for amphibious operations. Historically, amphibious operations have been constrained by the requirement to establish a lodgment ashore and by reliance on Navy command and control during the assault. Although amphibious-based vertical assault has been a MAGTF maneuver technique for more than 30 years, amphibious operations have not exploited the full potential of maneuver warfare. STOM takes advantage of emerging mobility and command and control systems to maneuver landing forces in their tactical array from the moment they depart their ships in order to project a combined-arms force by air and surface means directly against inland objectives. True STOM is not aimed at seizing a beach. Its goal is to thrust combat units ashore at their decisive place, in their fighting formations, and in sufficient strength to ensure mission accomplishment. Landing forces

will engage enemy units only as necessary to achieve the freedom of action required to accomplish operational objectives. STOM replaces the preponderous ship-to-shore movement of current amphibious warfare with true amphibious maneuver.

Although STOM's focus is on the operational objectives ashore, the sea becomes an essential maneuver space for the landing force to generate the tempo it needs to exploit enemy weaknesses. STOM provides the opportunity to achieve tactical as well as operational surprise, which has been hard to obtain in past amphibious operations. Operations will progress with a speed and flexibility of maneuver that will deny the enemy warning and reaction time. Vulnerabilities will be exploited before they are corrected, opportunities seized before they vanish, and traps sprung before they are discovered. Tactical flexibility that is combined with reliable intelligence will allow the landing force to bypass, render irrelevant, or unhinge and collapse the enemy's defensive measures. Opposing forces will not be able to react effectively or in time.

STOM operations will rely on highly capable multi-role aircraft with assault support assets that are capable of much longer ranges and greater combat payloads. These operations will also require a substantially improved aviation command and control system. Control of aircraft and missiles in this environment will require greatly enhanced information integration, coordination, and execution.

Command, control, communications, computers, and intelligence will become even more critical as traditional lines of coordination become less distinct and/or overlap in the widely dispersed, dynamic, and fluid operations of tomorrow. In a nonlinear battlespace, advanced command and control and information systems and the shared situational awareness that they create among Marine leaders will have an increasingly profound impact on all operations. Accurate, real-time information will enhance weapon accuracy, aircraft survivability, friendly maneuver, and all

aspects of force protection. It will also reduce the possibility of fratricide.

The Common Aviation Command and Control System (CAC2S) will integrate the functions of aviation command and control into an interoperable naval system that supports OMFTS. In conjunction with organic sensors and weapons systems, CAC2S will bring Marine aviation command and control fully on line with other joint command and control systems and support MACCS missions with a suite of scalable modules. CAC2S components are specifically designed to be operated in an expeditionary mode, thereby providing the equipment to support any operational contingency.

### **8003. Sustained Operations Ashore**

Although the MAGTF will continue to possess the capability to conduct initial forcible entry through OMFTS, the MAGTF's full potential lies in its capability to function as an operational maneuver element for the JFC in sustained operations ashore. The employment, organization, and basing of the MAGTF will be responsive to the requirements of the JFC and to specific circumstances within the area of operations. The MAGTF of the future will provide the JFC with an agile, versatile, and responsive force that is able to strike directly at operational centers of gravity or critical vulnerabilities. Therefore, the MAGTF will be one of the JFC's principal tools for conducting decisive maneuver. In sustained operations ashore, the MAGTF will be primarily seabased, but some elements of the MAGTF will go ashore to create or exploit an operational advantage, achieve greater integration with Army or Air Force components, or provide increased depth in aviation support or sustainment.

Future basing options during sustained operations ashore must support both fixed-wing and rotary-wing tactical aircraft with a mobile, self-deploying capability. This will significantly reduce deck cycles and transit time from amphibious shipping

to an inland objective area. Reduction of refueling and rearming times is as critical as minimizing flight time from bases to the objective area. The time that ground personnel can save refueling and rearming will equate to greater responsiveness and increased aircraft time on station, which supports the MAGTF over the entire objective area.

To support OMFTS, the MAGTF must continue to use FOBs to increase its depth of support and sustainment of aviation forces ashore. The purpose of the FOB is to decrease response time and to minimize turnaround time in support of sustained operations ashore. EAF operations are key to the Marine Corps' ability to establish FOBs in austere locations ashore. FARP operations can further extend the reach and responsiveness of aviation forces and can be run from an expeditionary FOB. The introduction of short takeoff and vertical landing aircraft, with their ability to operate from shorter runways, will reduce the need for conventional runways and their associated arresting equipment. These aircraft must be designed to operate from any combination of expeditionary fields, existing runways, hard surface roads, or sea based.

### **8004. MPF 2010 and Beyond**

OMFTS requires a more robust ability to conduct in-stream offloading and to accommodate various levels of combat loading than currently exist. Existing technologies must be exploited and new technologies pursued that will permit the next generation MPF to contribute to operational employment of MAGTFs across the full range of operations, including the rapid reinforcement of forward-deployed amphibious forces. MPF 2010 and Beyond is the concept under which the next generation MPFs will contribute to forward presence and power projection. These capabilities will remain central to U.S. deterrence and conflict resolution strategies. MPF 2010 and Beyond will provide indefinite sustainment by serving as a seabased conduit for logistic support. This support will flow from bases located in the United States or overseas via the seabase provided by MPF 2010 and Beyond then on to Marine units conducting operations at sea or ashore. This may

be accomplished as part of a larger, seabased logistic effort that includes not only MPSs, but also TAVBs, hospital ships, and offshore petroleum distribution systems.

Future MPSs will not have a true forcible entry capability, but they will be able to reinforce the striking power of an ATF. Future MPFs will participate in OMFTS by using selective offloading capabilities to reinforce the assault echelon of an

ATF. MPSs will be multipurpose and will provide facilities for the tactical employment of assault support aircraft, surface assault craft, advanced assault amphibious vehicle, and the ships' own organic lighterage. The ships' communications systems will be fully compatible with the tactical command and control architecture of the ATF. This will allow access to the advanced capabilities and shared situational awareness of future command and control systems.



## Appendix A

# Marine Aviation Organization

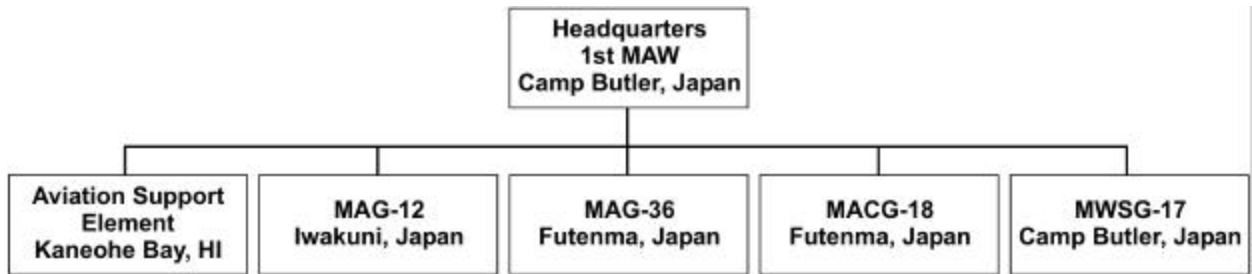

Figure A-1. 1st Marine Aircraft Wing.

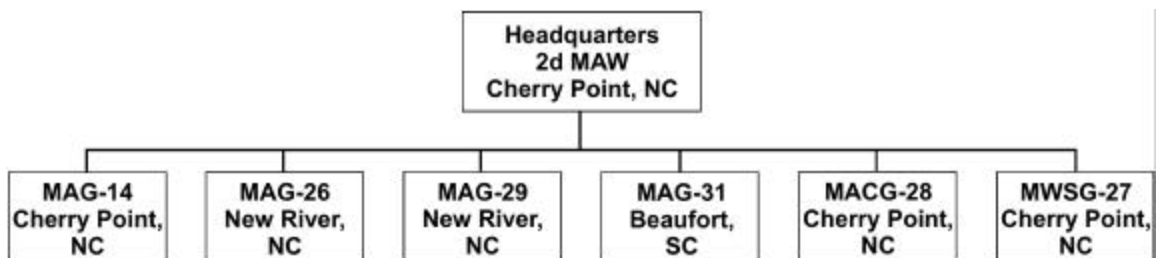

Figure A-2. 2d Marine Aircraft Wing.

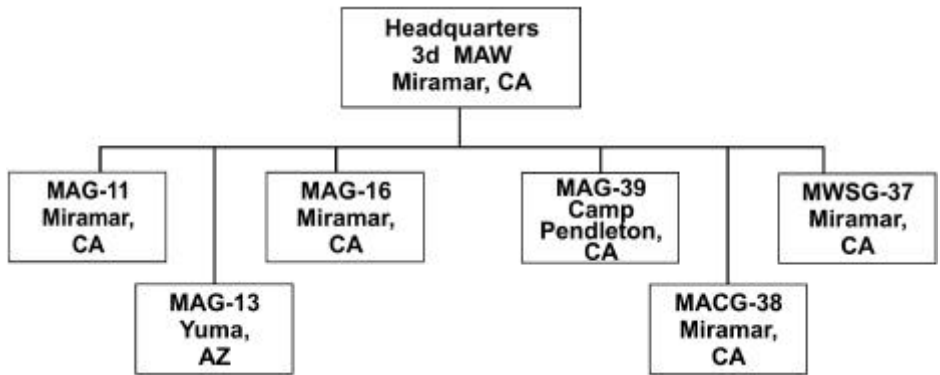

Figure A-3. 3d Marine Aircraft Wing.

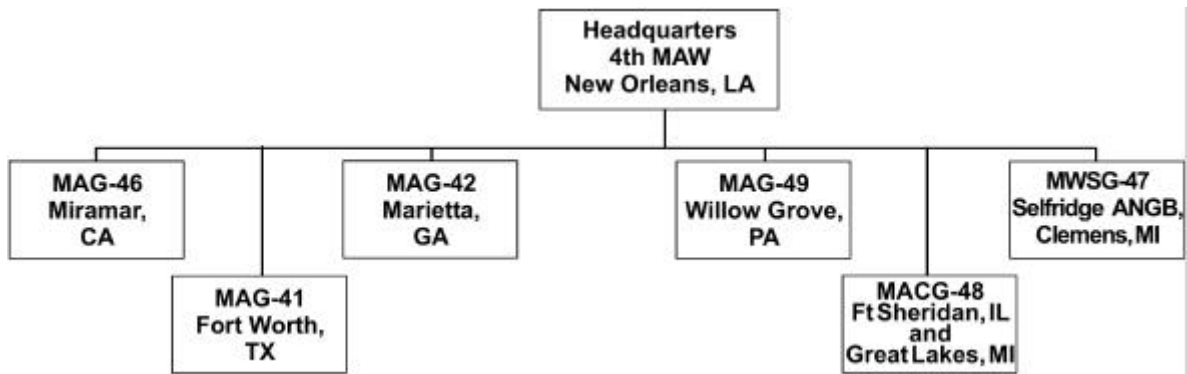

Figure A-4. 4th Marine Aircraft Wing.

## Appendix B

# Glossary

### Section I. Acronyms and Abbreviations

AADC .....	area air defense commander	EA .....	electronic attack
AAW .....	antiair warfare	EAF .....	expeditionary airfield
ACA .....	airspace control authority	EP .....	electronic protection
ACE .....	aviation combat element	ES .....	electronic warfare support
ACP .....	airspace control plan	EW .....	electronic warfare
ADCON .....	administrative control	EW/C .....	early warning/control
AIMD .....	aircraft intermediate maintenance department	FAC .....	forward air controller
ALD .....	aviation logistics division	FAC(A) .....	forward air controller (airborne)
AOC .....	airfield operations center	FARP .....	forward arming and refueling point
ARG .....	amphibious ready group	FFCC .....	force fires coordination center
ASC(A) .....	assault support coordinator (airborne)	FIE .....	fly-in echelon
ASE .....	air support element	FISP .....	fly-in support package
ATARS .....	advanced tactical airborne reconnaissance system	FMF .....	Fleet Marine Force
ATC .....	air traffic control	FOB .....	forward operating base
ATF .....	amphibious task force	FOSP .....	follow-on support package
ATO .....	air tasking order	FRAGO .....	fragmentary order
BDA .....	battle damage assessment	FREST .....	Fleet replacement enlisted student training
CAC2S .....	Common Aviation Command and Control System	FSCC .....	fire support coordination center
CAS .....	close air support	FSSG .....	force service support group
CE .....	command element	GCE .....	ground combat element
COA .....	course of action	HMH .....	Marine heavy helicopter squadron
COC .....	combat operations center	HMLA .....	Marine light/attack helicopter squadron
CONUS .....	continental United States	HMM .....	Marine medium helicopter squadron
CSAR .....	combat search and rescue	HST .....	helicopter support team
CSP .....	contingency support package	JAOC .....	joint air operations center
CSS .....	combat service support	JCSAR .....	joint combat search and rescue
CSSE .....	combat service support element	JFACC .....	joint force air component commander
CTAPS .....	Contingency Theater Automated Planning System	JFC .....	joint force commander
CVBG .....	carrier battle group	JFLCC .....	joint force land component commander
DAS .....	deep air support	JFMCC .....	joint force maritime component commander
DASC .....	direct air support center		
DCA .....	defensive counterair		

JP.....	joint publication	NATO .....	North Atlantic Treaty Organization
JSTARS .....	joint surveillance, target attack radar system	NDP .....	naval doctrine publication
JTF .....	joint task force	NEO .....	noncombatant evacuation operation
LAAD .....	low-altitude air defense	NGF .....	naval gunfire
LAN .....	local area network	OAAW .....	offensive anti-air warfare
LHA .....	general purpose amphibious assault ship	OAS .....	offensive air support
LHD .....	multipurpose amphibious assault ship (with internal dock)	OCA .....	offensive counterair
MACCS .....	Marine air command and control system	OMFTS .....	operational maneuver from the sea
MACG .....	Marine air control group	OPCON .....	operational control
MACS .....	Marine air control squadron	OPLAN .....	operation plan
MAG .....	Marine aircraft group	PDE&A .....	planning, decision, execution, and assessment
MAGTF .....	Marine air-ground task force	SAAWC .....	sector anti-air warfare coordinator
MAG VF/VA .....	fixed-wing MAG	SAM.....	surface-to-air missile
MAG VH .....	rotary-wing MAG	SEAD .....	suppression of enemy air defenses
MALS .....	Marine aviation logistics squadron	SPMAGTF .....	special purpose MAGTF
MALSP .....	Marine Aviation Logistic Support Program	STOM .....	ship-to-objective maneuver
MASS.....	Marine air support squadron	TAC(A).....	tactical air coordinator (airborne)
MATCD .....	Marine air traffic control detachment	TACC.....	tactical air command center
MAW .....	Marine aircraft wing	TACON.....	tactical control
MCDP .....	Marine Corps doctrinal publication	TACP .....	tactical air control party
MCPP .....	Marine Corps Planning Process	TAOC.....	tactical air operations center
MCRP .....	Marine Corps reference publication	TAVB.....	aviation logistics support ship
MCWP .....	Marine Corps warfighting publication	TBMCS .....	Theater Battle Management Core System
MEF .....	Marine expeditionary force	TOC .....	tactical operations center
METT-T .....	mission, enemy, terrain and weather, troops and support available—time available	UAV .....	unmanned aerial vehicle
MEU.....	Marine expeditionary unit	UNAAF.....	Unified Action Armed Forces
MEU(SOC)	Marine expeditionary unit (special operations capable)	VMA .....	Marine attack squadron
MOOTW .....	military operations other than war	VMAQ .....	Marine tactical electronic warfare squadron
MPF .....	maritime prepositioning force	VMAT.....	Marine attack training squadron
MPS .....	maritime prepositioning ships	VMFA .....	Marine fighter/attack squadron
MTACS.....	Marine tactical air command squadron	VMFA(AW).....	Marine fighter/attack (all weather) squadron
MWCS .....	Marine wing communications squadron	VMFAT .....	Marine fighter/attack training squadron
MWHS .....	Marine wing headquarters squadron	VMGR .....	Marine aerial refueler transport squadron
MWSG .....	Marine wing support group	VMGRT .....	Marine aerial refueler transport training squadron
MWSS.....	Marine wing support squadron	VMM .....	Marine medium tilt-rotor squadron
		VMMT .....	Marine medium tilt-rotor training squadron

VMO-6.....	Marine Observation Squadron (Fixed-Wing)-6	V/STOL .....	vertical/short takeoff and landing
VMU .....	Marine unmanned aerial vehicle squadron	WAN.....	wide area network

## Section II. Definitions

**aviation combat element**—The core element of a Marine air-ground task force that is task-organized to conduct aviation operations. The aviation combat element provides all or a portion of the six functions of Marine aviation necessary to accomplish the Marine air-ground task force's mission. These functions are anti-air warfare, offensive air support, assault support, electronic warfare, air reconnaissance, and control of aircraft and missiles. The aviation combat element is usually composed of an aviation unit headquarters and various other aviation units or their detachments. It can vary in size from a small aviation detachment of specifically required aircraft to one or more Marine aircraft wings. The aviation combat element may contain other Service or foreign military forces assigned or attached to the Marine air-ground task force. The aviation combat element itself is not a formal command. Also called **ACE**. (approved for next edition of MCRP 5-12C)

**air board**—In Navy/Marine Corps operations, all squadron flight schedules are consolidated with the needs of the MAGTF/ship/ARG/CVBG at an air board. The air board meets every day in the SACC. It works on current and future plans for air support. The results are published as the ship/ARG/CVBG air plan. The air board also provides the input for the joint ATO. (proposed definition for MCRP 5-12C)

**air superiority**—That degree of dominance in the air battle of one force over another which permits the conduct of operations by the former and its related land, sea and air forces at a given time and place without prohibitive interference by the opposing force. (JP 1-02)

**air tasking cycle**—The cyclical planning process that Marine aviation planners use to plan air operations in support of the MAGTF mission and to produce the MAGTF ATO or air plan. The six phases of the MAGTF air tasking cycle are command aviation guidance, target/air support mission development, allocation and allotment, tasking, force execution, and combat assessment. (The parallel six-phase joint air tasking cycle is described in JP 3-56.1.) (proposed definition for MCRP 5-12C)

**allocation (air)**—The translation of the air apportionment decision into total numbers of sorties by aircraft type available for each operation or task. (JP 1-02)

**allotment**—The temporary change of assignment of tactical air forces between subordinate commands. The authority to allot is vested in the commander having combatant command (command authority).

**apportionment**—In the general sense, distribution for planning of limited resources among competing requirements. Specific apportionments (e.g., air sorties and forces for planning) are described as apportionment of air sorties and forces for planning, etc. (JP 1-02) See also **allocation (air)**; **apportionment (air)**. (JP 1-02)

**apportionment (air)**—The determination and assignment of the total expected air effort by percentage and/or by priority that should be devoted to the various air operations and/or geographic areas for a given period of time. (JP 1-02)

**base defense zone**—An air defense zone established around an air base and limited to the engagement envelope of short-range air defense weapons systems defending that base. Base defense zones have specific entry, exit, and identification, friend or foe procedures established. (JP 1-02)

**battlespace**—All aspects of air, surface, subsurface, land, space, and electromagnetic spectrum which encompass the area of influence and area of interest. (MCRP 5-12C)

**battlespace dominance**—The degree of control over the dimensions of the battlespace which ensures friendly freedom of action and denies enemy freedom of action. It permits force sustainment and application of power projection to accomplish the full range of potential operational and tactical missions. It includes all actions conducted against enemy capabilities to influence future operations. (MCRP 5-12C)

**carrier battle group**—A standing naval task group consisting of a battle group command and control element organized and trained to command naval, joint and combined operations. It consists of an aircraft carrier with embarked air wing, surface combatants, submarines, and other assigned forces with organic combat logistics, operating as a cohesive, task-organized unit to achieve battlespace dominance over designated areas both ashore and afloat and to project power ashore. Also called a **CVBG**. (Navy proposal for revision of JP 1-02)

**centers of gravity**—Those characteristics, capabilities, or localities from which a military force derives its freedom of action, physical strength, or will to fight. (JP 1-02)

**close operations**—Military actions conducted to project power decisively against enemy forces which pose an immediate or near term threat to the success of current battles or engagements. These military actions are conducted by committed forces and their readily available tactical reserves, using maneuver and combined arms. (MCRP 5-12C)

**coalition force**—A force composed of military elements of nations that have formed a temporary alliance for some specific purpose. (JP 1-02)

**combined arms**—The full integration of combat arms in such a way that to counteract one, the enemy must become more vulnerable to another. (MCRP 5-12C)

**critical vulnerability**—An aspect of a center of gravity that if exploited will do the most significant damage to an adversary's ability to resist. A vulnerability cannot be critical unless it undermines a key strength. (MCRP 5-12C)

**deep operations**—Military actions conducted against enemy capabilities which pose a potential threat to friendly forces. These military actions are designed to isolate, shape, and dominate the battlespace and influence future operations. (MCRP 5-12C)

**flight ferry**—The self-deployment of aircraft from one station to another. Although conduct of the movement is administrative in character, its purpose may be operational.

**force sustainment**—Capabilities, equipment, and operations that ensure continuity, freedom of action, logistic support, and command and control. (MCRP 5-12C)

**joint force**—A general term applied to a force composed of significant elements, assigned or attached, of two or more Military Departments, operating under a single commander authorized to exercise operational control. (JP 1-02)

**joint force air component commander**—The joint force air component commander derives authority from the joint force commander who has the authority to exercise operational control, assign missions, direct coordination among subordinate commanders, redirect and organize forces to ensure unity of effort in the accomplishment of the overall mission. The joint force commander will normally designate a joint force air component commander. The joint force air component commander's responsibilities will be assigned by

the joint force commander (normally these would include, but not be limited to, planning, coordination, allocation, and tasking based on the joint force commander's apportionment decision). Using the joint force commander's guidance and authority, and in coordination with other Service component commanders and other assigned or supporting commanders, the joint force air component commander will recommend to the joint force commander apportionment of air sorties to various missions or geographic areas. Also called **JFACC**. (JP 1-02)

**main effort**—The designated subordinate unit whose mission at a given point in time is most critical to overall mission success. It is usually weighted with the preponderance of combat power and is directed against a center of gravity through a critical vulnerability. (MCRP 5-12C)

**maneuver warfare**—A warfighting philosophy that seeks to shatter the enemy's cohesion through a variety of rapid, focused, and unexpected actions which create a turbulent and rapidly deteriorating situation with which the enemy cannot cope. (MCRP 5-12C)

**Marine air-ground task force**—The Marine Corps principal organization for all missions across the range of military operations, composed of forces task-organized under a single commander capable of responding rapidly to a contingency anywhere in the world. The types of forces in the Marine air-ground task force (MAGTF) are functionally grouped into four core elements: a command element, an aviation combat element, a ground combat element, and a combat service support element. The four core elements are categories of forces, not formal commands. The basic structure of the Marine air-ground task force never varies, though the number, size, and type of Marine Corps units comprising each of its four elements will always be mission dependent. The flexibility of the organizational structure allows for one or more subordinate MAGTFs, other Service and/or foreign military forces, to be assigned or attached. Also called **MAGTF**. (approved for next edition of MCRP 5-12C)

**operational level of war**—The level of war at which campaigns and major operations are planned, conducted, and sustained to accomplish strategic objectives within theaters or areas of operations. Activities at this level link tactics and strategy by establishing operational objectives needed to accomplish the strategic objectives, sequencing events to achieve the operational objectives, initiating actions, and applying resources to bring about and sustain these events. These activities imply a broader dimension of time or space than do tactics; they ensure the logistic and administrative support of tactical forces, and provide the means by which tactical successes are exploited to achieve strategic objectives. (JP 1-02)

**power projection**—The application of measured, precise offensive military force at a chosen time and place, using maneuver and combined arms against enemy forces. (MCRP 5-12C)

**rear operations**—Military actions conducted to support and permit force sustainment and to provide security for such actions. (MCRP 5-12C)

**rules of engagement**—Directives issued by competent military authority which delineate the circumstances and limitations under which United States forces will initiate and/or continue combat engagement with other forces encountered. Also called **ROE**. (JP 1-02)

**sortie**—In air operations, an operational flight by one aircraft. (JP 1-02)

**special purpose Marine air-ground task force**—A Marine air-ground task force organized, trained and equipped with narrowly focused capabilities. It is designed to accomplish a specific mission, often of limited scope and duration. It may be any size, but normally it is a relatively small force—the size of a Marine expeditionary unit or smaller. It may contain other Service or foreign military forces assigned or attached to the Marine air-ground task force. Also called **SPMAGTF**.

**strategic level of war**—The level of war at which a nation, often as a member of a group of nations, determines national or multinational (alliance or coalition) security objectives and guidance, and develops and uses national resources to accomplish these objectives. Activities at this level establish national and multinational military objectives; sequence initiatives; define limits and assess risks for the use of military and other instruments of national power; develop global plans or theater war plans to achieve these objectives;

and provide military forces and other capabilities in accordance with strategic plans. (JP 1-02)

**tactical level of war**—The level of war at which battles and engagements are planned and executed to accomplish military objectives assigned to tactical units or task forces. Activities at this level focus on the ordered arrangement and maneuver of combat elements in relation to each other and to the enemy to achieve combat objectives. (JP 1-02)



## Appendix C

# References and Related Publications

### Joint Publications (JPs)

0-2	Unified Action Armed Forces (UNAAF)
1-02	Department of Defense Dictionary of Military and Associated Terms
2-0	Doctrine for Intelligence Support to Joint Operations
2-01.1	Joint Tactics, Techniques, and Procedures for Intelligence Support to Targeting (under development)
3-0	Doctrine for Joint Operations
3-01.5	Doctrine for Joint Theater Missile Defense
3-04.1	Joint Tactics, Techniques and Procedures for Shipboard Helicopter Operations
3-07	Joint Doctrine for Military Operations Other Than War
3-09	Doctrine for Joint Fire Support
3-09.3	JTTP for Close Air Support (CAS)
3-50.2	Doctrine for Joint Combat Search and Rescue
3-52	Doctrine for Joint Airspace Control in a Combat Zone
3-56.1	Command and Control for Joint Air Operations
5-0	Doctrine for Planning Joint Operations

### Naval Doctrinal Publications (NDPs)

1	Naval Warfare
3	Naval Operations
4	Naval Logistics

### Marine Corps Publications

#### Marine Corps Doctrinal Publications (MCDPs)

1	Warfighting
1-1	Strategy
1-2	Campaigning
1-3	Tactics
2	Intelligence
3	Expeditionary Operations
4	Logistics
5	Planning
6	Command and Control

**Marine Corps Warfighting Publications (MCWPs)**

- 0-1 Marine Corps Operations (under development)
- 0-1.1 Componentency
- 2-1 Intelligence Operations
- 2-11 MAGTF Intelligence Collection (under development)
- 2-15.4 Imagery Intelligence (under development)
- 3-16 Fire Support Coordination (under development)
- 3-21.1 Aviation Ground Support (under development)
- 3-22 Anitair Warfare
- 3-22.1 Multi-Service Procedure for Antiradiation Missile Employment in a Joint Environment (ARM-J)
- 3-23.1 Close Air Support
- 3-24 Assault Support
- 3-24.1 Helicopter Operating Procedures for Air-Capable Ships
- 3-25 Control of Aircraft and Missiles
- 3-25.1 Integrated Combat Airspace C2 (ICAC 2) Manual (under development)
- 3-25.2 Multi-Service Procedures for Theater Air-Ground Systems (TAGS)
- 3-25.3 Marine Air Command and Control System Handbook
- 3-25.4 Marine Tactical Air Command Center Handbook
- 3-25.5 Direct Air Support Center Handbook
- 3-25.6 Marine Sector Anti-air Warfare Coordinator Handbook
- 3-25.7 Tactical Air Operations Center Handbook
- 3-25.8 Marine Air Traffic Control Detachment Handbook
- 3-25.9 Marine Air Command and Control Systems Communications Handbook (under development)
- 3-25.10 Low Altitude Air Defense Handbook
- 3-25.11 Low Altitude Air Defense (LAAD) Gunner's Handbook (under development)
- 3-35.7 MAGTF Meteorology and Oceanography (METOC) Support
- 4-11.7 MAGTF Supply Operations
- 5-1 Marine Corps Planning Process
- 5-11.1 MAGTF Aviation Planning (under development)
- 6-2 MAGTF Command and Control (under development)

**Marine Corps Reference Publications (MCRPs)**

- 3-22A Multi-Service Procedures for EA-6B Employment in the Joint Environment (J-PROWLER)
- 3-23A Multi-Service Procedures for Joint Air Attack Team Operations
- 3-25A Multi-Service Procedures for Joint Air Traffic Control (JATC)
- 3-25B Multi-Service Air-Air, Air-Surface, and Surface-Air Brevity Codes
- 5-11.1A Aviation Planning Documents (under development)
- 5-12A Operational Terms and Graphics
- 5-12C Marine Corps Supplement to the Department of Defense Dictionary of Military and Associated Terms
- 5-12D Organization of Marine Corps Forces

**Marine Corps Bulletin (MCBul)**

- 3501 Maritime Prepositioning Force (MPF) Marine Air-Ground Task Force (MAGTF) Force List

**Miscellaneous**

. . . From the Sea

Forward . . . From the Sea

MAGTF Aviation and Operational Maneuver From the Sea