

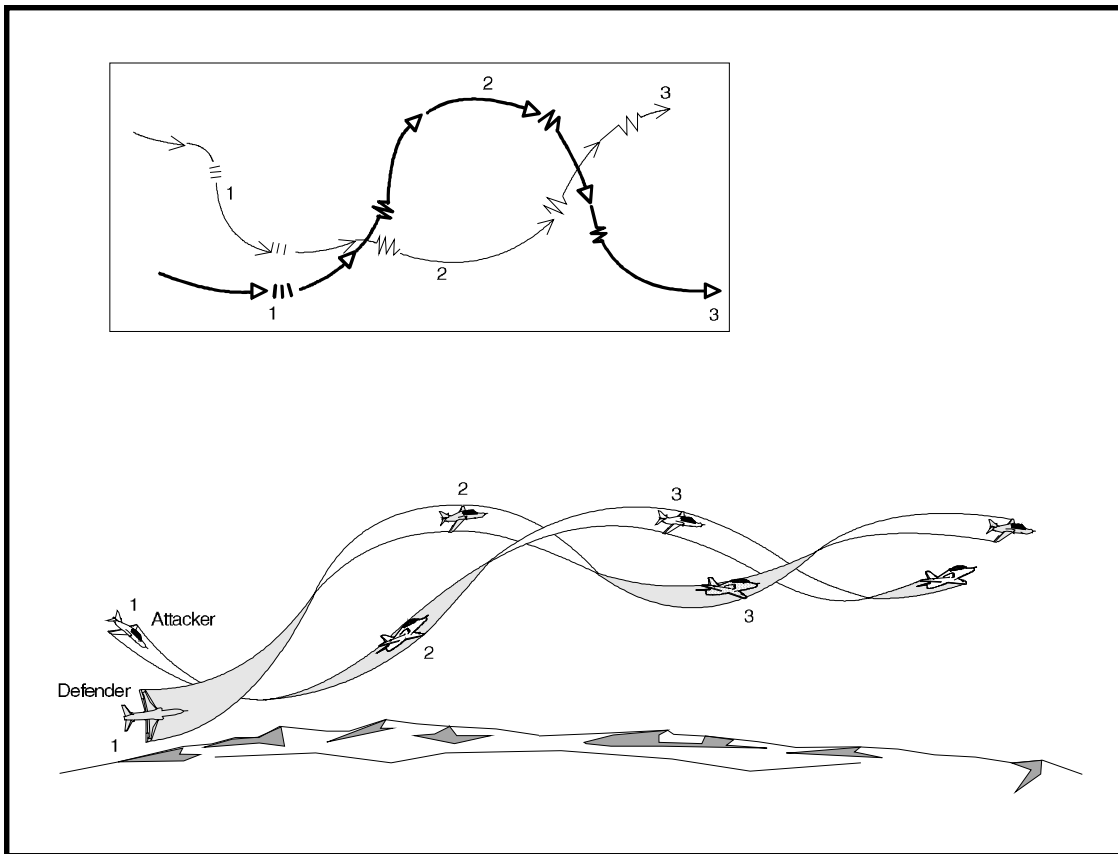

AIR COMBAT MANEUVERING FLIGHT PROCEDURES



FLIGHT SUPPORT LECTURE GUIDE

**FLIGHT SUPPORT LECTURE GUIDE
LIST OF EFFECTIVE PAGES**

| EFFECTIVE PAGES | PAGE NUMBERS | EFFECTIVE PAGES | PAGE NUMBERS |
|--------------------|-----------------|--------------------|-----------------|
| ACMFP-01 | | | |
| Original | Title page(s) | | |
| Original | 1-1 thru 1-34 | | |
| ACMFP-02 | | | |
| Original | Title page(s) | | |
| Original | 2-1 thru 2-38 | | |
| ACMFP-03 | | | |
| Original | Title page(s) | | |
| Original | 3-1 thru 3-36 | | |
| ACMFP-04 | | | |
| Original | Title page(s) | | |
| Original | 4-1 thru 4-12 | | |
| ACMFP-06 | | | |
| Original | Title page(s) | | |
| Original | 6-1 thru 6-102 | | |

FLIGHT SUPPORT LECTURE GUIDE

COURSE/STAGE: T-45A UJPT, ADV, & IUT Air Combat Maneuvering

LESSON TITLE: Introduction to ACM

LESSON IDENTIFIER: T-45A UJPT, ADV, & IUT ACMFP-01

LEARNING ENVIRONMENT: Classroom

ALLOTTED LESSON TIME: .8 hr

TRAINING AIDS:

- * ACMFP CD-ROM
- * T-45 Scale Model

STUDY RESOURCES:

- * T-45A NATOPS Flight Manual, A1-T45AB-NFM-000
- * Air Combat Maneuvering Flight Training Instruction (FTI)

LESSON PREPARATION:

Read:

- * T-45A ACM FTI "Introduction" and "Background" sections with special attention to symbology and terminology

REINFORCEMENT: N/A

EXAMINATION:

The objectives in this lesson will be tested in ACMFP-05X.

(10-98) ORIGINAL

THIS PAGE INTENTIONALLY LEFT BLANK.

LESSON OBJECTIVES**6.7.2.1**

Relate environmental components to ACM performance

6.7.2.3

Relate fixed aircraft factors to ACM performance

6.7.2.4

Relate variable aircraft factors to ACM performance

6.7.2.6.1

Identify energy management components for the T-45A

6.7.8.5

Recall procedure for the performance characteristics exercise

6.7.2.2

Recall basic ACM considerations

6.7.3.5.2

Recall the actions which lead to a one-circle fight

6.7.3.5.5

Recall the advantages/disadvantages of a one-circle fight

6.7.3.5.3

Recall the actions which lead to a two-circle fight

6.7.3.5.6

Recall the advantages/disadvantages of a two-circle fight

6.7.3.5.7

Recall out-of-plane (OOP) maneuveringtactical considerations

6.7.6.1.1

Recall procedures for maintaining sight/lookout doctrine

6.7.1.2

Recall ACM terminology and descriptions

6.7.1.3

Recall ACM symbology

6.7.1.1

Recall training rules for ACM exercises

6.7.1.1.2

Recall procedure for lost comm situation in ACM

6.7.1.1.1

Recall procedure for lost sight situations in ACM

6.7.4.10.3

Recall procedures for conducting G-LOC turns

*Video
Sg 0, fr 2*

MOTIVATIONAL
VIDEO

NOTE: You cannot stop the video after it has started to play. Select "Navigate" to choose the next frame if you do not want to view the entire video.

MOTIVATION

As a major element of America's first line of defense, pilots involved in incidents like this one spend many hours, day and night, to be prepared for that moment. They already know what you are about to find out.

ACM is not something that you learn quickly. You will not become an ace by the end of the ACM block of instruction. You will, however, learn several concepts that will take years to perfect: 1) speed is life—never reach a point where you end up out of airspeed and ideas; 2) know your aircraft to make the enemy fight your fight, not vice versa; 3) your game plan and your reactions in an engagement must be executed automatically; 4) the best fighters press the edge of their operating envelope all the time.

OVERVIEW

This lesson enables you to utilize ACM principles, terminology, and symbology during your preparation for ACM engagements.

In this lesson you will be studying:

- * ACM overview—real world and training command
- * ACM considerations
- * ACM terminology and symbology
- * ACM training rules

REFRESHER

This lesson builds on information presented previously. In particular, recall:

- * T-45A TacForm FTI
 - Mutual support concepts
 - Communications and strategies in loose deuce maneuvering

INTRODUCTION TO ACM

Sg 1, fr 1

- * **Overview**
- * ACM considerations
- * ACM terminology and symbology
- * ACM training rules

PRESENTATION

I. ACM Overview

A. Goal

1. Overall (real world)
 - a. Gain firing solution and destroy aircraft
 - b. Deny firing solution to another aircraft
2. Training Command—to execute maneuvers and practice engagements necessary to reach a firing solution or deny bandit firing solution

Sg 1, fr 2

*Use T-45A
Scale
Model*

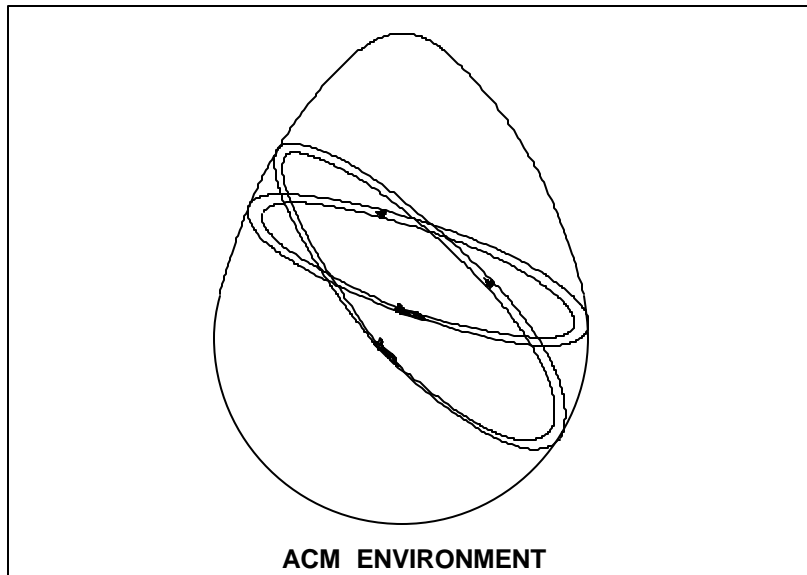

B. ACM environment **6.7.2.1**

1. Three dimensions—defined by longitudinal, lateral, and vertical axes
 - a. Can describe an infinite number of ACM planes from vertical through oblique to horizontal
 - b. Force of gravity
 - (1) Gravity—pulls downward on aircraft
 - (2) Load factor (indicated g)
 - (a) Oriented perpendicular to aircraft wing
 - (b) Vertical component (effective lift) offsets gravity
 - (c) Horizontal component (radial g) used to turn aircraft

Sg 1, fr 3

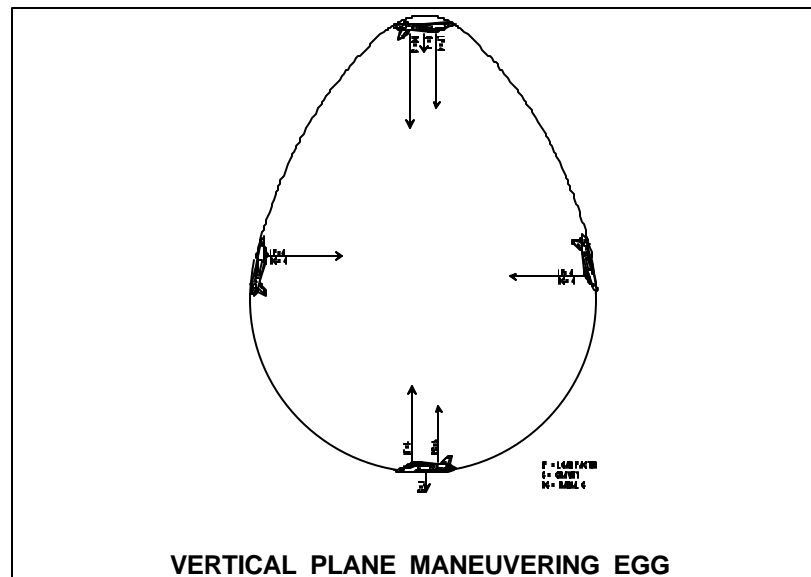

2. "The egg"—represents three dimensional sphere showing effects of gravity and lift vectors on maneuvering
 - a. Vertical maneuvering
 - (1) Represents theoretical loop in vertical plane at constant TAS and constant indicated g
 - (2) Radial g—sum of indicated cockpit g and force of gravity
 - (3) When lift vector above horizon (bottom of egg), radial g lower because of gravity
 - (a) Larger turn radius
 - (b) Slower turn rate
 - (4) When lift vector below horizon (top of egg—fighter inverted), radial g higher because gravity adds to load factor
 - (a) Smaller radius
 - (b) Faster turn rate

- (5) Aircraft pure vertical (side of egg)
- (a) Load factor equals radial g
- (b) Results in intermediate turn performance

Sg 1, fr 4

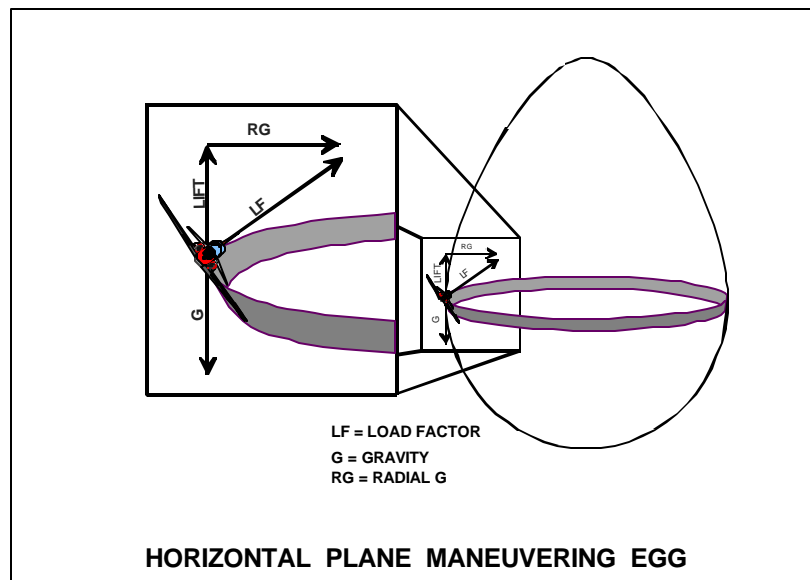

b. Horizontal maneuvering

LESSON NOTES

The instructor/SNP may refer to Figure 2 in the ACM FTI for a more thorough explanation of horizontal maneuvering.

- (1) Represents theoretical circle in horizontal plane at constant TAS and constant indicated g

- (2) Effect of gravity affects horizontal turn performance significantly
- (3) Load factor
 - (a) Lift component overcomes gravity
 - (b) Remaining radial g component enables turn

Sg 1, fr 5

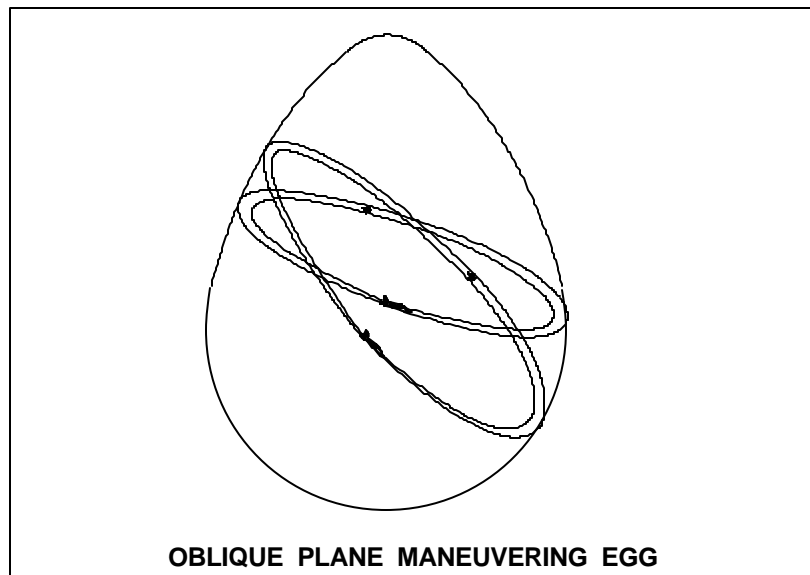

- (4) Results in reduced turn performance due to forces being divided
- c. Oblique maneuvering
- (1) Gravity affects oblique maneuvering in similar manner as it does in the vertical and the horizontal depending upon steepness of maneuvering plane

- (2) Regardless of plane of maneuver
 - (a) Lift vector above horizon—detracts from turn performance
 - (b) Lift vector below horizon—helps turn performance
- d. Geometry of tactics—effective ACM, both offensive and defensive, requires timely and dynamic use of multiple planes of maneuvering

LESSON NOTES

Emphasize the importance of maneuvering in the oblique plane to capitalize on the bandit's horizontal turn performance.

Sg 1, fr 6

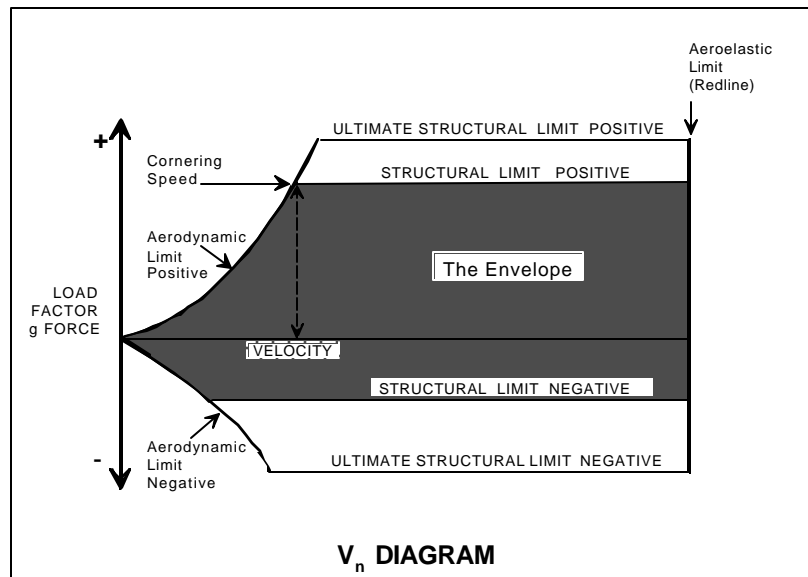

C. Operational maneuverability—changes in altitude, airspeed and direction limited by fixed and variable factors

1. Fixed factors **6.7.2.3**

a. Structural limitations

- (1) Maximum lift that can be supported by airframe structure without yielding
- (2) Maximum g capability—lift/gross weight (limitations vary with fuel/ordnance loads)
- (3) Operating envelope (V_n diagram) displays load factor g limitations

b. Thrust-to-weight

- (1) Thrust varies with altitude and temperature
- (2) Independent of airspeed (jet aircraft)
- (3) Ratio equals aircraft thrust divided by combat weight
- (4) Used to compare performance of aircraft

-
-
- c. Wing loading—combat weight/wing area
 - (1) Aircraft with higher wing loading has larger turn radius and slower turn rate
 - (2) Aircraft with lower wing loading has smaller turn radius and faster turn rate

 - 2. Variable factors **6.7.2.4**
 - a. Altitude—provides potential energy (PE) for maneuvering
 - b. Airspeed—kinetic energy (KE): as altitude increases, TAS increases for constant KIAS airspeed
 - c. Angle of attack
 - (1) At a given AOA, coefficient of lift and drag is constant regardless of airspeed, gross weight, and altitude
 - (2) In an engaging turn (energy sustaining turn), corresponding AOA reflects optimum lift to drag ratio

NOTE: Optimum AOA's are explained in the following energy management section.
 - d. G loading
 - (1) Ratio of lift to weight
 - (2) In turns or direction changes, lift must exceed weight, and g loads greater than 1 g are necessary
 - (3) At constant TAS, as g is increased so does AOA
 - (4) Radial g—determines turn radius and rate
 - (5) Instantaneous g
 - (a) Maximum lift a wing may generate at a given airspeed
 - (b) Dependent upon aircraft airframe/wing

- (c) Displayed on velocity load factor (V_n) diagram
 - (d) ACM relationship—used to generate maximum rate of turn
- (6) Sustained g
- (a) A function of aircraft thrust available with respect to wing loading
 - (b) Maximum g capability in level turn with constant airspeed
 - (c) Increases with higher thrust-to-weight ratio
 - (d) ACM relationship—to maintain energy throughout an engagement
- e. Turn radius
- (1) Distance that aircraft displaces laterally in turn
 - (2) Dependent on TAS and g with constant altitude— TAS^2/g
 - (3) TAS has a greater effect on turn radius than rate
 - (4) Sustainability—given two aircraft at constant TAS, the aircraft that can sustain most g will have the smallest turn radius
- f. Turn rate
- (1) Equates to pitch rate in horizontal plane
 - (2) Dependent on TAS and g with constant altitude (g/TAS)
 - (3) Given two aircraft at a constant TAS, the aircraft that can sustain most g will have fastest turn rate
 - (4) Instantaneous—maximum available turn rate at any given airspeed without regard to energy sustainability

3. Total energy (TE)—combination of aircraft's altitude (PE) and airspeed (KE)

NOTE: Determining the TE advantage determination for a given aircraft is difficult because of the possible speed differences between fighters.

- a. Specific excess power (P_s)—measures ability of aircraft to increase its energy state by using excess thrust

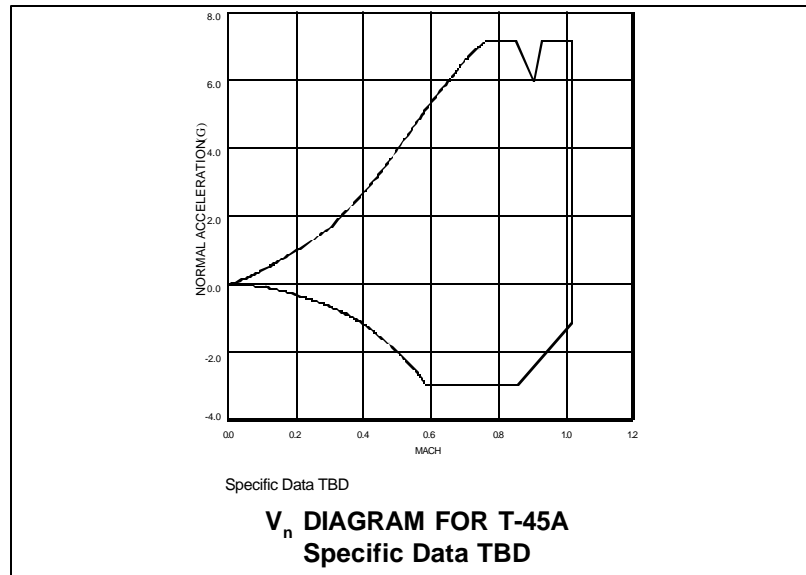
Sg 1, fr 7

b. Cornering speed

NOTE: Cornering speed has previously been referred to as maneuvering speed.

- (1) Minimum airspeed at which maximum structural g can be attained (airspeed for maximum turn rate and minimum turn radius)
- (2) Below this speed
 - (a) Buffet or stall exists at aerodynamic limit
 - (b) Turn radius increases and turn rate decreases at aerodynamic limit
- (3) Above this speed with increased available g
 - (a) Structural limits exceeded resulting in overstress at structural limit
 - (b) Turn radius increases and rate decreases at structural limit

NOTE: Remember that V_n diagrams show only instantaneous turn performance.

D. Energy management for the T-45A **6.7.2.6.1**

1. Cornering speed is approximately 410 kts
2. Maneuvering airspeed band roughly 300-350 KIAS

E. Performance characteristics exercise **6.7.8.5**

1. Purpose—to demonstrate timed turns, timed accelerations, and zero-air-speed departures
2. Application
 - a. Set-up: separate from wingman, climb to 15,000 ft MSL, establish desired airspeed and level flight
 - b. Execution
 - (1) Timed turns
 - (a) At 300 kt, fly a cardinal heading
 - (b) Execute an energy sustaining turn (13-14 units) at MRT for 180 degrees, maintaining 300 kts (IP will record time)
 - (c) Reestablish cardinal heading, execute hard turn (17 units) at MRT for 180 degrees of turn, maintaining 300 kts (IP will record time and energy loss)
 - NOTE: The nose will have to be below the horizon to maintain 300 kts.
 - (d) Climb back to 15,000 ft and reestablish cardinal heading, execute maximum performance turn (break turn 19-21 units) at MRT for 180 degrees of turn, attempting to maintain 300 kts (IP will record time and energy loss)

NOTE: The nose will have to be below the horizon to maintain 300 kts.

(2) Timed acceleration

(a) From 250 kts at level flight, go to MRT and accelerate in level flight to 300 kts, (IP will record time)

(b) Reestablish airspeed at 250 kts, go to MRT, and unload the aircraft to 5-10 units to arrive at 300 kts, (IP will record time)

(3) Zero airspeed departures: same as in OCF

3. Common errors

a. Problem: during maximum performance turn, failing to maintain 19-21 units due to unfamiliarity with aircraft performance

Correction: avoid tendency to relax back stick

*Sg 2, fr 1***INTRODUCTION TO ACM**

- * Overview
- * **ACM considerations**
- * ACM terminology and symbology
- * ACM training rules

*Sg 2, fr 2***ACM CONSIDERATIONS**

- * Mind-set
- * Game plans
- * Out-of-plane (OOP) maneuvering
- * Lookout

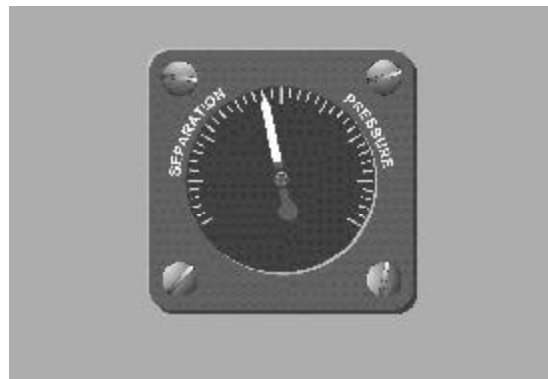
Sg 2, fr 3**MIND-SET****II. ACM considerations****A. Mind-set 6.7.2.2****1. Pressure**

- a. Aggressive
 - b. Many airspeed excursions for position advantage
 - c. Deny opponent's superior weapon system or turn rate advantage
2. Separation
- a. Conservative
 - b. Exploit superior, all-aspect weapons
 - c. Fewer excursions from target airspeed band (normally corner)
-

Sg 2, fr 4

GAME PLANS

- * One-Circle
- * Two-Circle

B. Game plans

Sg 2, fr 5

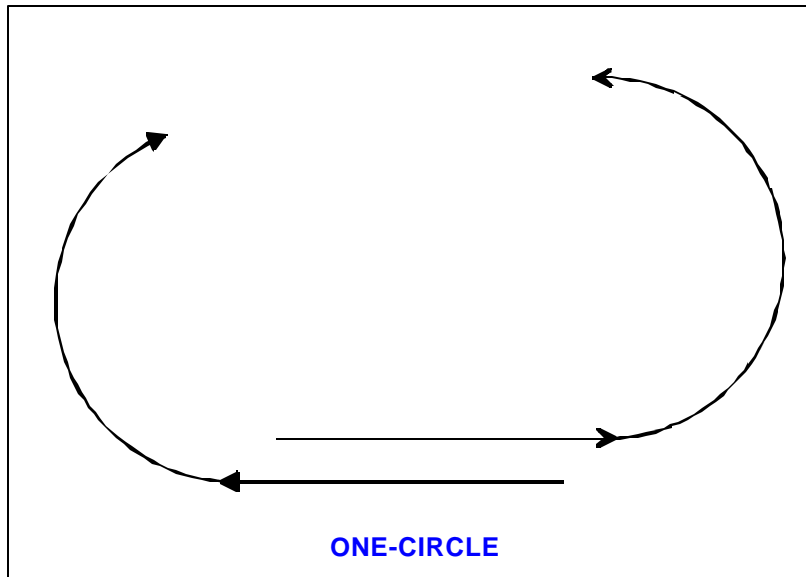

1. One-circle **6.7.3.5.2, 6.7.3.5.5**
 - a. Both aircraft fighting for control of the same turn circle
 - b. Position advantage goes to aircraft with smallest turn circle

Sg 2, fr 6

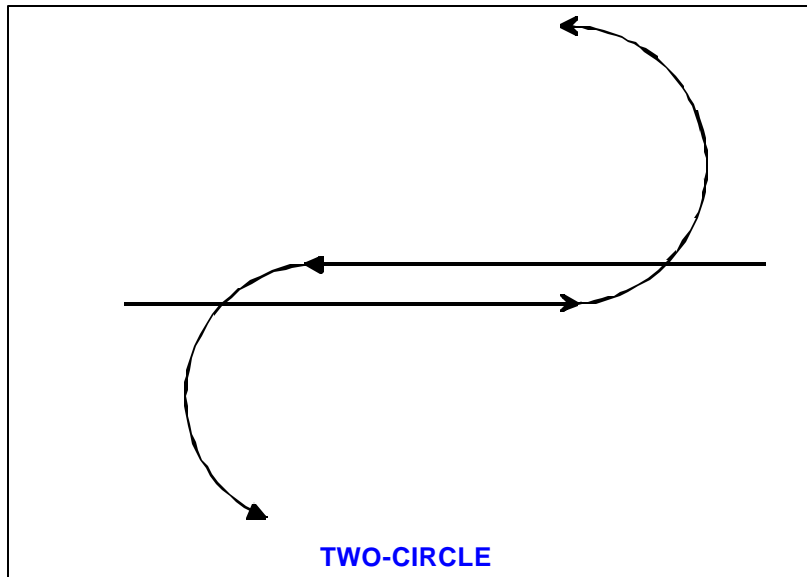

2. Two-circle **6.7.3.5.3, 6.7.3.5.6**

- a. Both aircraft maneuvering within their own turn circle for weapon separation/position advantage
- b. Advantage to aircraft with best turn rate

Sg 2, fr 7

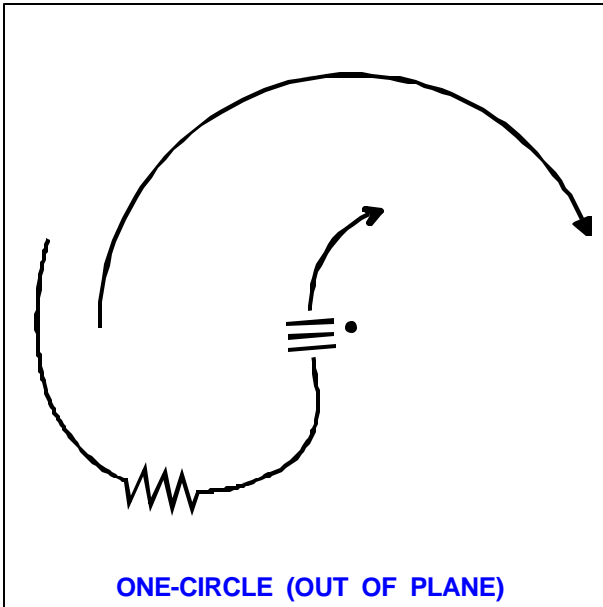

Sg 2, fr 8

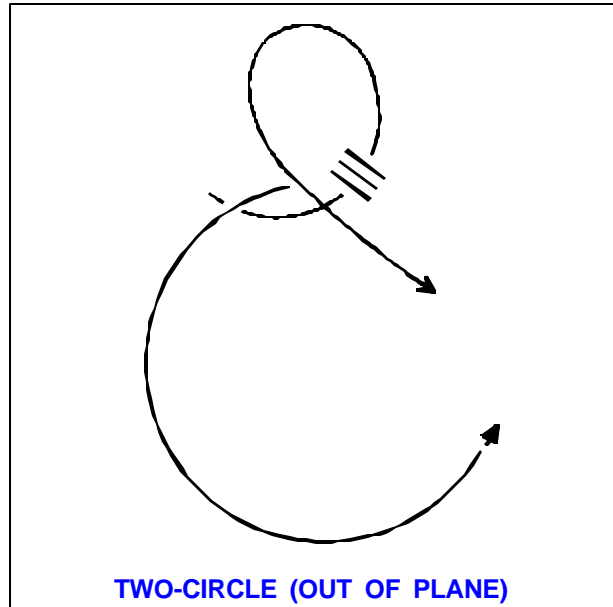

C. Out-of-plane (OOP) maneuvering **6.7.3.5.7**

1. With respect to bandit's plane of motion (POM)
2. Nose high—collapse turn circle and/or stop closure
3. Nose low—increase turn rate/decrease turn radius

Sg 2, fr 9

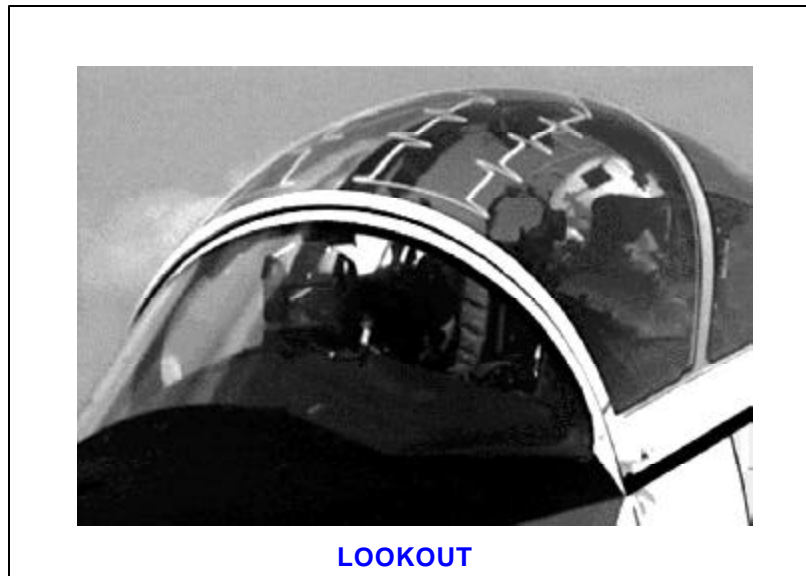

D. Lookout **6.7.6.1.1**

1. Key to winning any engagement is keeping sight
 - a. Preflight gear (no loose comm cords, scratched visors, ill-fitting masks, etc.)
 - b. Flexibility in cockpit (check for freedom of movement before you launch)
 - c. Learn to fly with one hand
2. Develop a lost sight game plan
 - a. Where was he headed the last time I saw him?
 - b. If he isn't there, could he have reversed?
 - c. Don't fixate on sun
 - d. For God's sake, keep fighting the jet while you look!

Sg 3, fr 1

INTRODUCTION TO ACM

- * Overview
- * ACM considerations
- * **ACM terminology and symbology**
- * ACM training rules

III. ACM terminology and symbology

A. Terminology **6.7.1.2**

1. Angles

a. Angle off the tail (AOT)

(1) Angle between defender's longitudinal axis and attacker's line-of-sight

(2) Attacker's position off defender's tail

b. Track crossing angle—angular difference in velocity vectors at any instant

2. Angels—altitude of aircraft in thousands of feet

3. Atoll

a. Soviet IR missile

b. Missile call used by bandit

4. Bandit—unidentified air contact
5. BFM—basic fighter maneuvering. Maneuvering to gain position advantage aft of opponent's wingline so that he may be killed
6. Blind—I do not see my lead/wingman
7. Break—maximum rate turn (20 units AOA) executed to destroy firing solution
8. Bubble—aircraft's max performance turn circle in any given POM
9. Bug out—disengage from ACM to exit safely from fight
10. Buster—fly at MRT
11. Contact—initial and subsequent detections of object by any detecting device
12. Control point—point approximately one instantaneous turn radius aft of the bandit (dependent on airspeed)
13. Control zone—region where all possible control points are located, generally defined as a cone beginning at +/- 20 degrees AOT at 2,000 ft aft of bandit and extending to +/- 40 degrees at 4,000 ft
14. Eyeball—in section forward quarter tactics, fighter who has tally/radar contact and will take bandit close aboard to obtain visual identification (VID) and facilitate his wingman acquiring tally for shot
15. FOX-2—AIM-9 IR missile firing solution
16. GUNS—rear quarter steady state or snap guns firing solution
17. Hard turn—compromise between maximum rate turn and energy conserving turn (300 kt at 17 units AOA)
18. Heads up—Enemy got through (part or all) or I am not in position to engage target

19. Joker—fuel state preparatory to bug out followed shortly thereafter by bugout call
20. Knock it off—Stop fight or current maneuvers
21. Line of Sight (LOS)—bearing to bandit relative to fighter
22. Lufbery—horizontal or slightly oblique stalemate engagement with both aircraft across the circle from each other, turning in same direction at low energy state
23. Merge plot—radar tracks have come together, cannot be distinguished from each other
24. Mil lead—the flight lead
25. No joy—I do not see the bandit
26. On the deck—at minimum altitude
27. Overshoot—two types:
 - a. 3/9 line overshoot—passing from aft of a bandit's wingline to in front of it
 - b. Flight-path overshoot—flying through a bandit's flight path aft of his 3/9 line. Further defined by its relation to Control Zone
28. Padlocked—I have tally and can't take my eyes off bandit for fear of losing contact due to visibility/range, etc.
29. Pigeons—the magnetic bearing and distance of home base (or unit indicated)
30. Pitchback—pulling vertically 60 degrees nose-high at 17 units AOA, used to attempt to meet the bandit head-on with minimum lateral separation in situations where the bandit is less than 1 mile, high above horizon, or at your dead six
31. POM—plane of motion. The two dimensional plane in which an aircraft's turn circle is being scribed.
32. Popeye—in clouds or area of reduced visibility

33. Post—the center of the bubble (one turn radius from the aircraft). The post determines pursuit curves needed for effective BFM.
34. Range—linear distance between two aircraft stated in nm or ft
35. SA (situational awareness)—cognizance of all factors in a tactical arena that affect mission success
36. Say state—transmit Fuel remaining
37. Shackle—turn made to redress section by crossing member to other side, thus resuming proper combat spread position
38. Shooter—as applied to section forward quarter tactics, fighter pulling for shot as his wingman passes close aboard and VIDs the bandit
39. Slice turn—a radical change in direction with minimal lateral displacement and energy/speed bleedoff performed by rolling to place the lift vector below the horizon at some oblique angle and applying g
40. Steady—I am on prescribed heading
41. Steady up—Roll out immediately on present heading
42. Tac (tactical) Lead—member of flight having best SA and directing section maneuvers (not always the Mil lead)
43. Tally—bandit visually sighted
44. Visual—wingman in sight

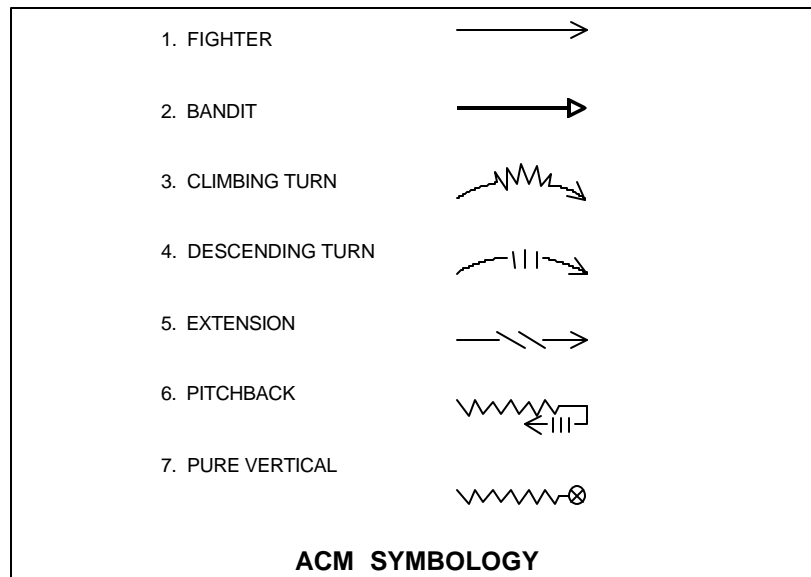
Sg 3, fr 2

B. Symbology **6.7.1.3**

1. Fighter
2. Bandit
3. Climbing turn
4. Descending turn
5. Extension
6. Pitchback
7. Pure vertical

INTRODUCTION TO ACM

- * Overview
- * ACM considerations
- * ACM terminology and symbology
- * **ACM training rules**

Sg 4, fr 1

IV. ACM training rules **6.7.1.1**

A. General

NOTE: The following ACM training rules apply to all ACM training and shall be strictly observed. These rules include those found in OPNAVINST 3710.7; however, pilots are responsible for knowing that directive.

1. ACM training shall be conducted only in designated areas.
2. All ACM participants shall attend face-to-face briefings and debriefings for each flight. Brief items shall include
 - a. Conduct of flight
 - b. CNATRA training rules
 - c. Selected safety of flight aspects
 - d. Maneuvers flown
 - e. Spin avoidance and recovery procedures
3. Termination of maneuvering shall be signaled by "Call sign" and "Knock it off."

NOTE: Upon hearing “Knock it off,” both aircraft should return to combat spread.

4. The minimum altitude (deck) for ACM is 10,000 ft AGL. The engagement shall automatically cease when any aircraft descends below 10,000 ft, and that aircraft shall be considered a “kill.”
5. An aircraft pursuing another aircraft in a descent shall monitor the defensive aircraft’s altitude/attitude and break off the attack with a turn away prior to either aircraft descending through the hard deck.
6. Aircraft configuration changes are limited to use of speed brakes.
7. Lost communications **6.7.1.1.2**
 - a. Two-way radio communication lost
 - (1) Terminate maneuvering
 - (2) Rock wings
 - (3) Set up 30-degree AOB rendezvous turn
 - b. Lost ICS with good radio
 - (1) Terminate maneuvering
 - (2) Transmit “Call sign” and “Knock it off”
 - (3) Set up 30-degree AOB rendezvous turn
8. If lost sight, perform the following procedure **6.7.1.1.1**
 - a. Transmit “Lost sight”
 - b. Other aircraft in flight will transmit further instructions
9. During horizontal scissors or weave, nose-high aircraft shall go high and nose-low aircraft shall go low. The low aircraft has the responsibility for maintaining flight separation. Always transmit “[Call sign]” and intent.

10. The aircraft in sun is responsible for safe separation.
 - a. If the “up-sun” aircraft loses sight, broadcast “Lost sight” and maintain a predictable course.
 - b. If “down-sun” aircraft loses sight, break off the attack, lag the up-sun aircraft, and broadcast “Lost sight.”
11. Maintain 500-ft bubble around your aircraft at all times; always assume the other aircraft does not see you.
12. On head-on passes, both aircraft will maintain the established trend. Where no trend exists, each aircraft will give way to the right to create a left-to-left pass. Broadcast your intentions.
13. No blind lead turns
14. A “G” awareness maneuver is required prior to ACM. Aircrew who experience “GLOC” shall immediately terminate ACM and return to base.
6.7.4.10.3
15. Minimum range for guns tracking is 1,000 ft, head-on guns are prohibited
16. A “Knock-it-off” will be called for any of the following situations:
 - a. Any violation of Training Rules
 - b. Dangerous situation/loss of situational awareness
 - c. Radio failure/loss of ICS (see #7 above)
 - d. Airspeed less than 80 kts
 - (1) nose-high and decelerating
 - (2) departure
 - (3) out-of-control flight
 - e. Unbriefed aircraft enters the flight
 - f. Aircraft enters a cloud

- g. Bingo fuel state reached
 - h. GLOC (see #14 above)
 - i. Training objectives have been met
- B. Weather—all engagements shall be conducted under VMC conditions with the following additions:
1. Minimum 5-statute-mile visibility with defined horizon
 2. Above or between cloud layers only with distinct horizon
 3. Minimum of 15,000 ft between broken/overcast layers
 4. Horizontal minimum of 1 nm horizontally and 2,000 ft vertically from all clouds
 5. Solo flight cloud tops shall not be higher than 7,000 ft AGL
 6. Dual flight cloud tops shall not be higher than 8,000 ft AGL
 7. Deck set at minimum 5,000 ft above all cloud tops

**INTRODUCTION TO ACM
REVIEW OPTIONS***Sg 5, fr 1*

1. Entire lesson
 2. Overview
 3. ACM considerations
 4. ACM terminology and symbology
 5. End this lesson
- Please select

SUMMARY

This lesson has focused on the following topics:

- * An overview of ACM goals, principles and strategies
- * ACM considerations
- * Terminology and symbology
- * Training rules

CONCLUSION

This concludes the introductory lecture for the ACM block of instruction. The following lectures present offensive and defensive strategies. You will then have an opportunity to practice these tactics in the air. Grasping the concepts presented in this lesson is key to understanding the material in later lectures and to flying victoriously in ACM engagements.

NOTES

FLIGHT SUPPORT LECTURE GUIDE

COURSE/STAGE: T-45A UJPT, ADV, & IUT Air Combat Maneuvering

LESSON TITLE: ACM 1 v 1 Offensive Maneuvering

LESSON IDENTIFIER: T-45A UJPT, ADV, & IUT ACMFP-02

LEARNING ENVIRONMENT: Classroom

ALLOTTED LESSON TIME: 1.0 hr

TRAINING AIDS:

- * ACMFP CD-ROM

STUDY RESOURCES:

- * T-45A NATOPS Flight Manual, A1-T45AB-NFM-000
- * Air Combat Maneuvering Flight Training Instruction (FTI)

LESSON PREPARATION:

Read:

- * T-45A ACM FTI "Offensive Flight Procedures" section

REINFORCEMENT: N/A

EXAMINATION:

The objectives in this lesson will be tested in ACMFP-05X.

(10-98) ORIGINAL

THIS PAGE INTENTIONALLY LEFT BLANK.

LESSON OBJECTIVES**6.7.3.1.1**

Recall the concepts and tactics applicable to offensive ACM

6.7.3.1.8

Recall the purpose and application of the snap guns exercise in ACM (offensive)

6.7.3.2.6.1

Recall the procedure for performing the snap guns exercise (offensive)

6.7.3.1.3

Recall the purpose and application of the high yo-yo in ACM

6.7.3.1.4

Recall the purpose and application of the low yo-yo in ACM

6.7.3.1.11

Recall the purpose and application of the horizontal scissors (offensive)

6.7.3.2.9.1

Recall procedure for performing horizontal scissors (offensive)

6.7.3.1.12

Recall the purpose and application of the rolling scissors (offensive)

6.7.3.2.10.1

Recall procedure for performing rolling scissors (offensive)

6.7.3.1.9

Recall the purpose and application of the offensive counter to the defensive pitchback

6.7.3.2.3

Recall procedures for performing low-angle hard counter (offensive)

6.7.3.2.8.1

Recall procedure for the “break turn” exercise (offensive)

6.7.3.1.10

Recall the offensive considerations for disengagement

6.7.3.6.2

Recall the procedures for execution of offensive disengagement

I

*Video
Sg 0, fr 2*

MOTIVATIONAL
VIDEO

NOTE: You cannot stop the video after it has started to play. Select "NAVIGATE" to choose the next frame if you do not want to view the video.

MOTIVATION

Fighter tactics exist to defeat other aircraft. The airplane itself may be considered a weapons platform designed to bring the weapons system into position for firing. Meeting these weapons-firing requirements must, therefore, be the goal of all fighter tactics and maneuvering.

You have just seen glimpses of the air war in Vietnam and Desert Storm. Naval fighters ended the Vietnam war with a 12.5:1 kill ratio. Before you make your first ACM flight, you must understand that your success as a fighter pilot depends on your commitment to be the victor not the victim.

OVERVIEW

This lesson prepares you to fly offensive 1 vs 1 air combat maneuvering.

In this lesson you will be studying:

- * Offensive [concepts/tactics](#)
- * Snap guns exercise
- * High yo-yo
- * Low yo-yo
- * Horizontal scissors
- * Rolling scissors
- * [Low-angle hard counter](#)
- * [Break turn exercise](#)
- * Disengagement

REFRESHER

This lesson builds on information presented previously. In particular, review:

- * Procedures for high/low yo-yo and displacement roll found in TFFP-03

Sg 1, fr 1

ACM 1 v 1 OFFENSIVE MANEUVERING

- * **Offensive concepts/tactics**
- * Offensive maneuvers
- * Disengagement/bugout

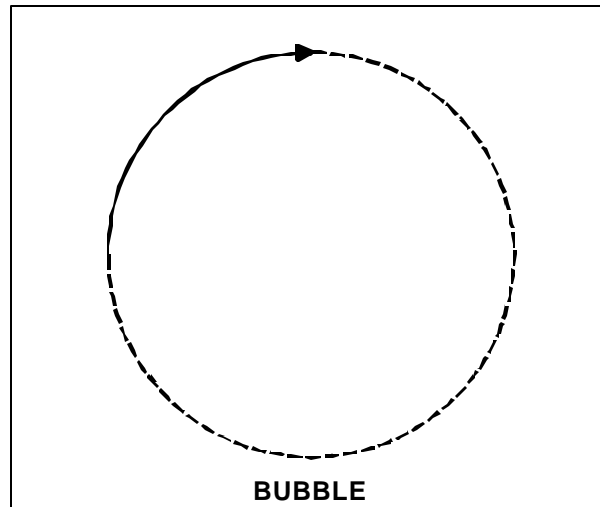
Sg 1, fr 2**PRESENTATION****I. Offensive concepts/tactics 6.7.3.1.1****A. The "bubble"**

1. Aircraft's maximum performance turn circle in any given POM
2. Fighter must be inside opponent's bubble to do any basic fighter maneuvering (BFM)

Sg 1, fr 3

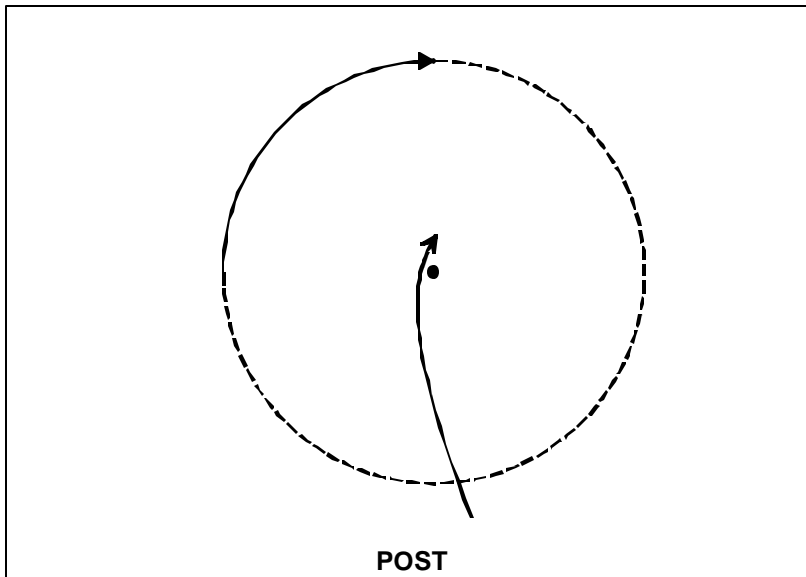

B. Post

1. Center of the bubble
2. Determines pursuit curve required
3. Holding lead pursuit ahead of bandit's post may result in 3/9 line overshoot and bandit reversal
4. Holding lead until aft of post will keep bandit in predictable flow

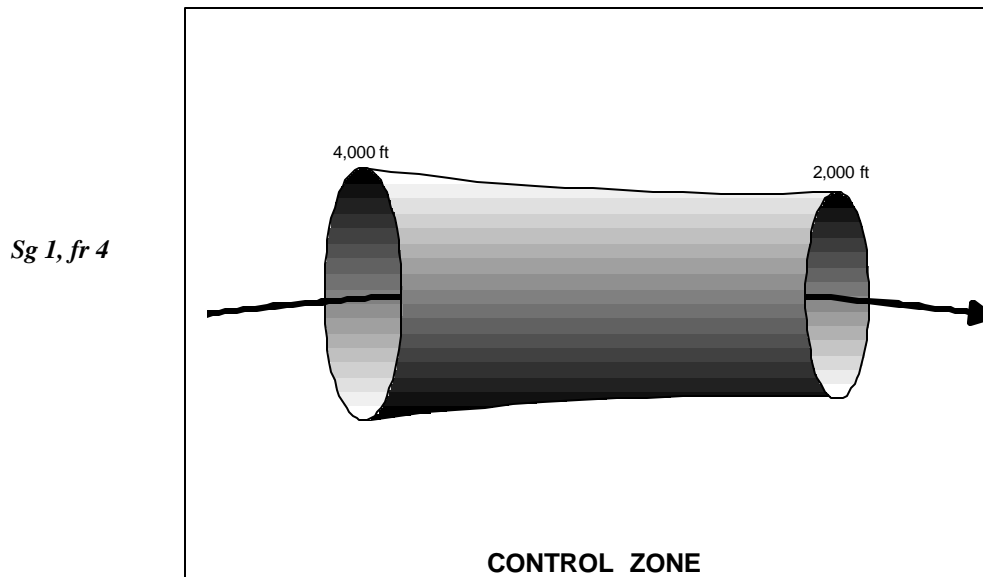

C. Control zone

1. Cone beginning approximately +/- 20 degrees from flight path, 2,000 ft aft of bandit, and extending to +/- 40 degrees of flight path, 4,000 ft aft
2. Position within control zone allows for missile shots and follow-on gunshots with minimal AOT
3. Denies bandit opportunity to reverse; keeps him predictable

Sg 1, fr 5

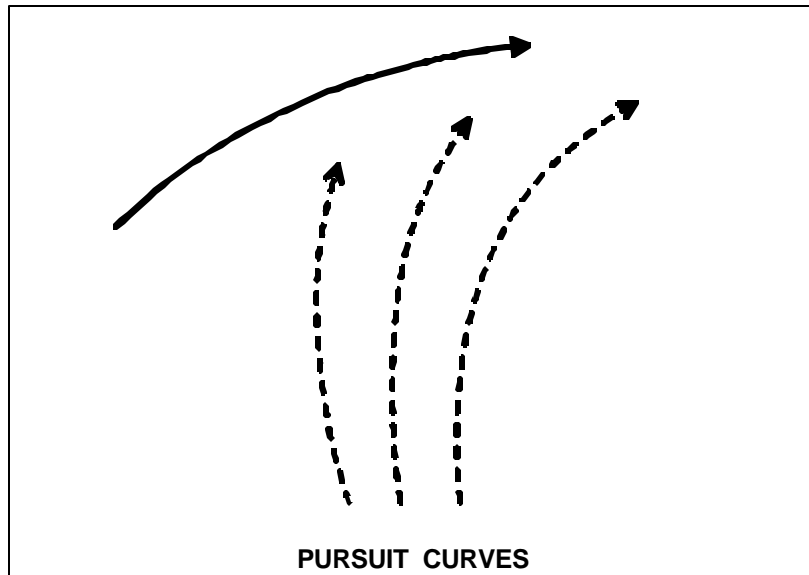

D. Pursuit curves

1. Chosen based on position relative to post/control zone/weapons envelope
2. When in bandit's POM, nose position determines pursuit
3. When in a different POM, lift vector determines pursuit

Sg 1, fr 6

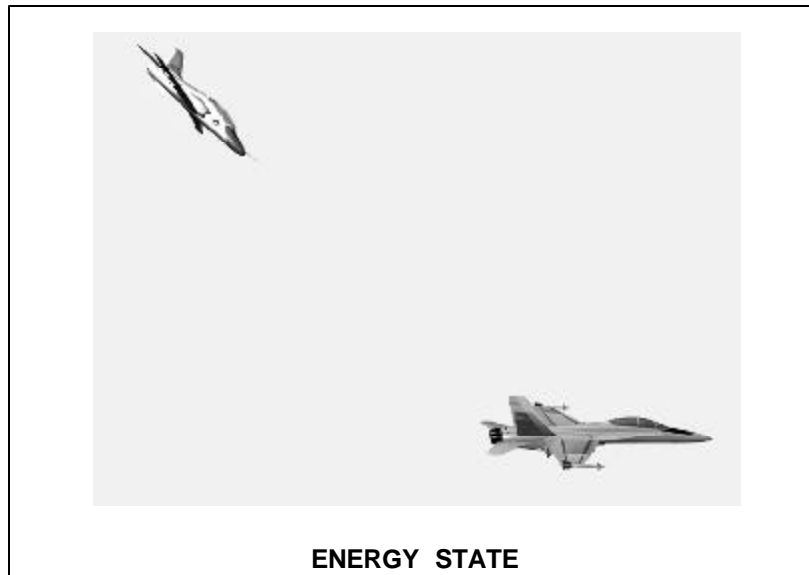

E. Energy state

1. Never arbitrarily give up energy
 - a. You may be willing to trade energy for position advantage or shot opportunities
2. Look for opportunities to regain energy (0 g provides optimum energy addition)
3. Recognize flow and modify energy accordingly
 - a. Two-circle flow requires sustained turn rate (higher airspeed gives more g available)
 - b. One-circle flow may require trading airspeed for altitude or position

Sg 2, fr 1

ACM 1 v 1 OFFENSIVE MANEUVERING

- * Offensive concepts/tactics
- * **Offensive maneuvers**
- * Disengagement/bugout

II. Offensive maneuvers

NOTE: In this lesson, offensive maneuvers are viewed from the attacker's perspective. Therefore, the attacker is the "fighter" (SNP) and the defender is the "bandit" (IP). The associated diagrams are labelled "Defender" and "Attacker" according to aircraft position in the fight, not according to role.

Sg 2, fr 2 Choose from menu to show animation or diagram and/or continue with the lesson.

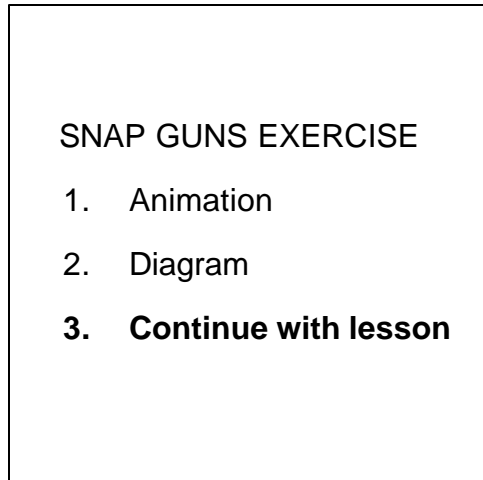

Animation (1)
Sg 2, fr 3

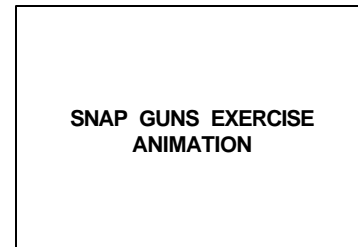
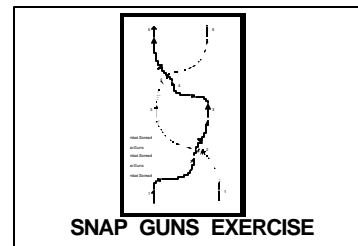

Diagram (2)
Sg 2, fr 4

Also may use T-45 Scale Model



A. Snap guns exercise **6.7.3.1.8**

1. Purpose—practice reaching snap guns envelope against maneuvering bandit
2. Application
 - a. Setup: [15,000 ft/300 KIAS/combat spread](#)
 - b. Execution **6.7.3.2.6.1**

LESSON NOTES

Whenever a topic is supported by both a screen projection and animated video, you will have a menu. You cannot stop the animation once it has begun to play. Choosing “Animation” will display the first frame of the animation. Select “MORE” to start the animation or “NAVIGATE” to return to the menu. Choosing “Diagram” will call up the screen projection, which will be a ribbon diagram or spaghetti diagram of the maneuver. Use your own discretion as to which you show first, and continue the lesson by choosing “Continue” at the end of the menu.

- (1) Bandit calls "In as the target" and turns with 45-60 degree AOB into fighter
- (2) Fighter calls "In as the shooter" and hard turns into bandit
- (3) Fighter reverses as bandit reaches 10 or 2 o'clock to achieve a snap guns solution of 60-90 degrees AOT
- (4) Bandit maneuvers out-of-plane to defeat gun solution
- (5) Fighter overshoots bandit because of high track crossing angle (TCA)
- (6) Bandit reverses back to approximately original heading as fighter overshoots
- (7) Both aircraft finish in combat spread ready to initiate subsequent attempts

3. Common errors

- a. Problem: delaying reversal and overshooting without reaching gun solution

Correction: reverse sooner and use back stick, and rudder to position nose into snap guns envelope

- b. Problem: reversing early and passing too close with too high AOT

Correction: turn away and pass outside of bandit's turn to avoid midair collision

Sg 2, fr 5 Choose from menu to show animation or diagrams and/or continue with the lesson.

HIGH AND LOW YO-YO

1. Animation
2. High yo-yo diagram
3. Low yo-yo diagram
4. **Continue with lesson**

Animation (1)
Sg 2, fr 6

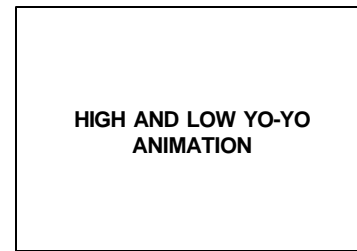
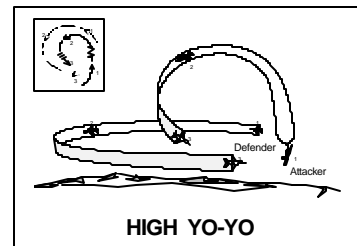

Diagram (2)
Sg 2, fr 8



B. High yo-yo **6.7.3.1.3**

1. Purpose
 - a. Method of employing lag pursuit
 - b. Prevent 3/9 line overshoot
 - c. Pre-position fighter noseup for follow-on one-circle fight should bandit reverse
2. Application
 - a. Setup—no specific set. BFM tactic
 - b. Execution
 - (1) As excessive closure is apparent, quarter roll away from bandit's plane of maneuvering (lag pursuit)
 - (2) Pull nose up to collapse turn circle relative to bandit's flight path
 - (3) If bandit reverses, minimize turn radius by trading airspeed for altitude and reposition lift vector aft of bandit

- (4) If bandit continues two-circle, immediately come out of the high yo-yo and regain airspeed to increase turn rate; low yo-yo may be required to bring nose to bear
- (5) Close to weapons envelope

LESSON NOTES

Point out that yo-yo's may be employed in any maneuvering plane.

3. Common errors

- a. Problem: overshoots because of 1) failure to recognize closure rate and 2) late execution of high yo-yo

Correction: anticipate need for reducing closure and execute high yo-yo to prevent overshoot (could result in possible horizontal scissors)

- b. Problem: holds high portion of yo-yo too long and allows bandit to increase nose-to-tail separation, thus losing advantage

Correction: with closure controlled and overshoot prevented, bring nose down to maintain nose-to-tail (could result in possible low yo-yo)

Sg 2, fr 5

Choose from menu to show animation or diagrams and/or continue with the lesson.

HIGH AND LOW YO-YO

1. Animation
2. High yo-yo diagram
3. Low yo-yo diagram
4. **Continue with lesson**

*Animation (1)
Sg 2, fr 6*

HIGH AND LOW YO-YO ANIMATION

*Diagram (3)
Sg 2, fr 9*

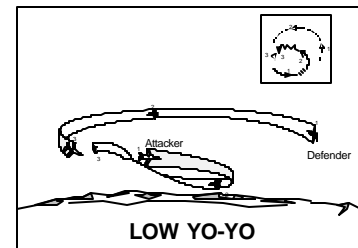

C. Low yo-yo 6.7.3.1.4

1. Purpose
 - a. Method of employing lead pursuit
 - b. Increases turn rate/AOT
2. Application
 - a. Setup—no specific set. BFM tactic
 - b. Execution
 - (1) Overbank to lower nose relative to bandit, increasing turn rate
 - (2) Pull inside bandit's turn (lead pursuit) and bring weapons to bear
 - (3) Be aware of increasing AOT and be prepared for possible overshoot inside of control zone
 - (4) Fire weapon when within weapons envelope

3. Common errors

- a. Problem: bleeding excessive energy while pulling inside bandit's turn

Correction: once lead pursuit is established, ease AOA to regain energy and regain closure

|

Sg 2, fr 10 Choose from menu to show animation or diagrams and/or continue with the lesson.

HORIZONTAL SCISSORS

1. Animation
2. Diagram
3. **Continue with lesson**

Animation (1)
Sg 2, fr 11

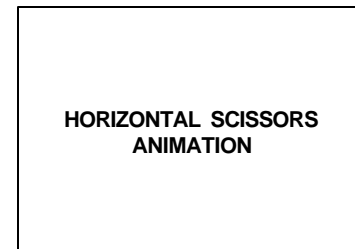
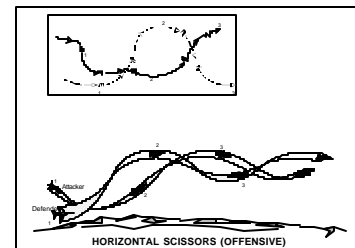

Diagram (2)
Sg 2, fr 13



D. Horizontal scissors **6.7.3.1.11**

1. Purpose: minimize loss of offensive position following 3/9 line overshoot
2. Application

- a. Setup: 14,000 ft co-altitude/250 KIAS/combat spread
- b. Execution **6.7.3.2.9.1**

(1) Fighter: calls in as “shooter” just as in snap-shot drill

Bandit: cooperatively maneuvers to place fighter in minimum range snap-shot envelope (60-90 degrees AOT)

(2) Fighter: at minimum range (1,000 ft) for guns, aggressively roll wings level and initiate maximum performance pull approximately 50-60 degrees nose high. Passing through 30-40 degrees nose high, reposition lift vector aft of the reversing bandit’s wingline with approximately 120-degree overbank

Bandit: attempt to capitalize on fighter overshoot with aggressive one-circle entry

- (3) Fighter: as airspeed bleeds, gradually reduce nose attitude/AOB to capture an airspeed which will allow for smallest turn circle (usually 130-150 KIAS). At 150 KIAS, coordinated stick/rudder will be required for aircraft control. Slower airspeeds will require turns to be initiated almost entirely with rudder

Bandit: establishes aircraft in best one-circle regime

(4) Fighter

- (a) Attempt to work for position advantage by flying a tighter turn circle than the bandit, thus creating turning room (through lag pursuit) which can be converted to position advantage (through a pull to lead)
- (b) Initiate reversal at bandit wingline to capitalize on lateral separation. If nose can be brought to bear at anytime in a valid gun envelope, put him out of his misery

Bandit: attempt to maximize AOT, expand width of the scissors and disengage

3. Common errors

- a. Problem: on initial overshoot, delaying turn back into bandit results in excessive down-range travel and possible loss of offensive advantage

Correction: initiate turn into bandit as soon as 30-degree nose-high attitude is reached

- b. Problem: on initial overshoot, failing to get nose-high enough resulting in excessive down-range travel and loss of offensive advantage

Correction: Continue to pull with lift vector aft of the bandit

- c. Problem: using excessive AOA that causes reduced directional control and aircraft acceleration, resulting in excessive down-range travel and loss of offensive advantage

Correction: release back pressure and avoid excessive buffet

- d. Problem: delaying reversal, resulting in increased lateral separation allowing bandit opportunity to increase AOT, compromising offensive position

Correction: [reverse at bandit wingline, taking lateral separation for position advantage and minimizing overshoot](#)

- e. Problem: remaining perched high on bandit resulting in going blind on bandit and perpetuating overshoots

Correction: pull power while maintaining other parameters to position for guns

NOTE: The ideal position to work a bandit in a horizontal scissors is below and behind his wingline with your guns sweeping through his aircraft.

- f. Problem: using excessive AOB during reversal causes nose to drop and aircraft to accelerate resulting in excessive down-range travel and loss of offensive advantage

Correction: [coordinate stick and rudder at high AOA/slow airspeed](#)

NOTE: At approximately 120 KIAS, the rudder is the primary control surface used to induce or stop rolling moments.

4. Follow-on

- a. [Expect bandit to attempt a disengagement by maximizing AOT and driving scissors as wide as possible.](#)
- b. [At first recognition of bandit bugout attempt, drop the nose to increase turn rate and bring nose to bear. If bandit pitches back and defeats your shot, assess your position with respect to his control zone and initiate a little BFM.](#)
- c. [If fighter positions himself for a valid gunshot while in scissors, expect bandit to redefine the fight by aggressively overbanking in a nose-low guns defense. The result could well be a tight two-circle spiral. AVOID EXCESSIVE LEAD! Be patient with it and let him deal with the deck.](#)

E. Rolling scissors **6.7.3.1.12**

1. Purpose

- a. Often the result of fighter overshooting the bandit in both the horizontal and vertical plane
- b. Often follows from a bandit counter to a barrel roll attack

NOTE: Demonstrate applicability of barrel roll attack when fighter attempts to achieve control zone positioning from a point inside bandit bubble, with significant AOT and fuselages closely aligned.

2. Application

- a. Setup: 15-16,000 ft (fighter stepped up)/250 KIAS/0.5 nm/60-70 degree AOT

Sg 2, fr 14

Choose from menu to show animation or diagrams and/or continue with the lesson.

ROLLING SCISSORS

1. Barrel roll attack animation
2. Barrel roll attack diagram
3. Rolling scissors animation
4. Rolling scissors diagram
5. Diagram--scissors positions
6. **Continue with lesson**

Animation (1)
Sg 2, fr 15

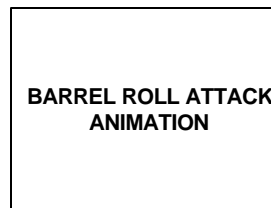
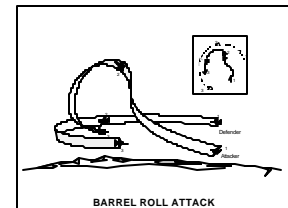

Diagram (2)
Sg 2, fr 17



Animation (3)
Sg 2, fr 18



Diagram (4)
Sg 2, fr 20

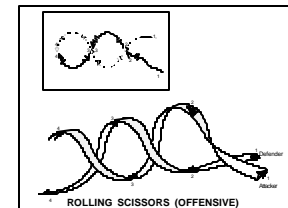
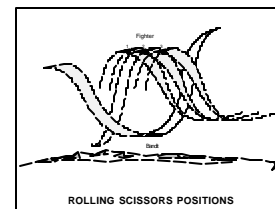

Diagram (5)
Sg 2, fr 21



b. Execution **6.7.3.2.10.1**

- (1) Fighter: starts conversion over top of barrel roll attack

Bandit: hard turns into fighter to cause horizontal overshoot and then pitches up vertically to generate vertical overshoot

- (2) Fighter

(a) Rolls in order to place lift vector on bandit

(b) Keeps lift vector on bandit using 17 units AOA until wings level on bottom

Bandit: attempts to generate a horizontal overshoot on top while executing barrel roll attack on fighter

(3) Fighter

- (a) Holds lift vector aft of bandit's 6
- (b) Pitches vertically 40-60 degrees nose-high depending on energy state
- (c) Uses 17 units AOA in pitchup
- (d) Rolls toward bandit in barrel roll attack to place lift vector on bandit

Bandit: overshoots vertically

(4) Both aircraft now locked in series of vertical and horizontal overshoots

c. Energy considerations

(1) Manage energy by using vertical/oblique plane

NOTE: In similar aircraft, the steepness of the climbs and dives determines the horizontal movement more than does the absolute speed differential.

- (a) Pull up wings level into vertical
 - (b) Make all heading changes (horizontal turns) by rolling off after reaching desired vertical attitude
- (2) Trade airspeed for altitude to reduce forward vector
- (3) Amount of acceleration depends on bandit's relative position to fighter

NOTE: Keep the lift vector perpendicular to other aircraft throughout maneuver except when taking advantage of vertical to reduce forward vector.

- (a) Monitor AOA to avoid buffet

- (b) Control airspeed gain in pullout to maintain the advantage
- (4) Maintaining the advantage
 - (a) Use 17-21 units AOA (lead pursuit) over top of each loop
 - (b) Maintain 14-17 units AOA (lag pursuit) along bottom of each loop, i.e., max AOA without buffet
- d. Effects of radial g
 - (1) Neutral—illusionary advantages/disadvantages
 - (a) Perspective as bottom aircraft—greater airspeed and bigger turn radius gives appearance of being forced out in front of top aircraft
 - (b) Perspective as top aircraft—less airspeed and smaller turn radius gives appearance of sliding back behind bottom aircraft
 - (2) Defensive and offensive—real advantage/disadvantage
 - (a) Perspective as bottom aircraft—greater airspeed and bigger turn radius gives appearance
 - i) Defensive—being in front of bandit forced to look aft when commencing vertical move
 - ii) Offensive—bandit forward of neutral point on your canopy
 - (b) Perspective as top aircraft—less airspeed and smaller turn radius gives appearance
 - i) Defensive—bandit aft of your aircraft
 - ii) Offensive—bandit directly underneath or forward of your aircraft

NOTE: If your nose is in-phase with the bandit, you are offensive, e.g., bandit nose-low approaching bottom; fighter established nose-low over the top.

3. Common errors

- a. Problem: rolling too rapidly placing lift vector in front of bandit

Correction: counter roll rate with opposite control force to keep lift vector on or slightly behind bandit

- b. Problem: rolling with insufficient rate resulting in excessive nose-low attitude

Correction: increase roll rate

- c. Problem: maintaining insufficient AOA over top resulting in nose-low attitude

Correction: increase AOA

4. Follow-on

- a. Conversion to horizontal scissors

NOTE: Approximately 2,500 ft above the hard deck is needed for a successful nose-low roll through the vertical to continue the rolling scissors.

- (1) Aircraft at top of roller remains nose-high and continues to pull back toward opponent's aircraft to generate horizontal overshoot
- (2) Instead of rolling through vertical, opponent's aircraft on top will reverse nose-high and pull back toward aircraft beginning vertical pullup resulting in horizontal scissors

- b. Bandit attempts disengagement from top of roller

- (1) Bandit fails to generate sufficient nose-to-tail separation

- (a) Fighter rolls off his vertical move early to reduce airspeed loss and minimize nose-to-tail separation
 - (b) Fighter pulls for shot and remains in phase using combination and/or variation of high and low yo-yo's
- (2) Bandit generates sufficient nose-to-tail separation, disengages successfully, and performs pitchback **6.7.3.1.9**

F. Low-angle hard counter **6.7.3.2.3**

- 1. Purpose: to successfully prosecute a bandit from a position near the control zone
- 2. Application
 - a. Setup—15-16,000 ft (fighter stepped up)/300 KIAS/approximately 40 degrees AOT

Sg 2, fr 22

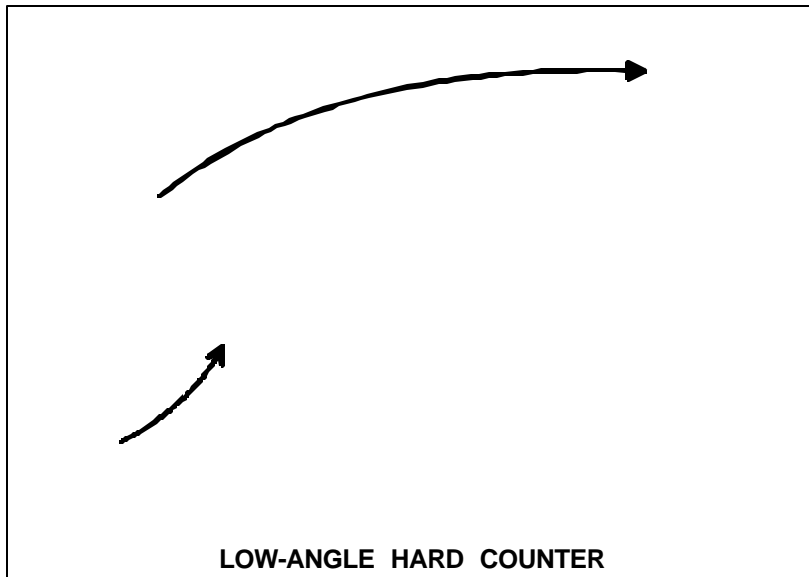

b. Execution

(1) Fighter: When cleared in, aggressively pull nose on for immediate FOX-2

Bandit: Break turn to defeat missile

Sg 2, fr 23

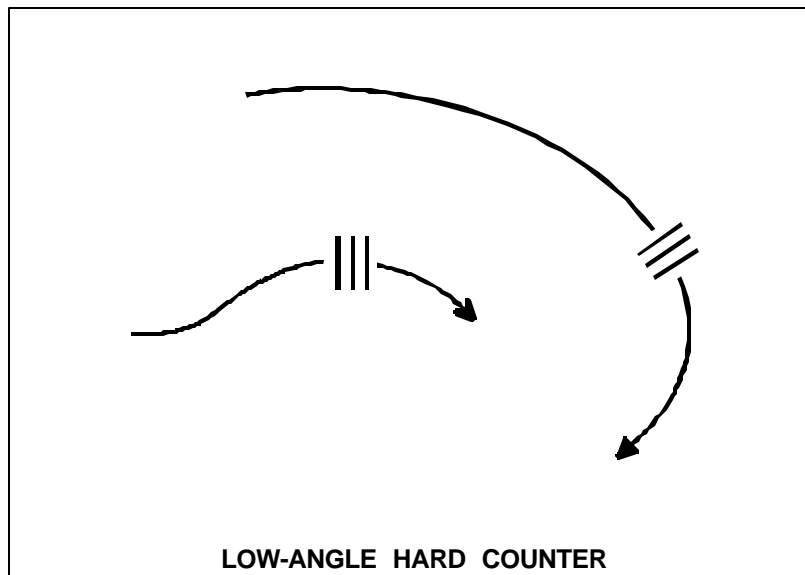

(2) Fighter: Assess bandit break turn while maintaining momentary pure pursuit

(a) Weak bandit break: pull lead as necessary to fill this girly-man fill of 20 MM

Transition to lag NLT minimum range with high yo-yo (if required) or simple reposition in plane. Key is to not give bandit reversal option

Sg 2, fr 24

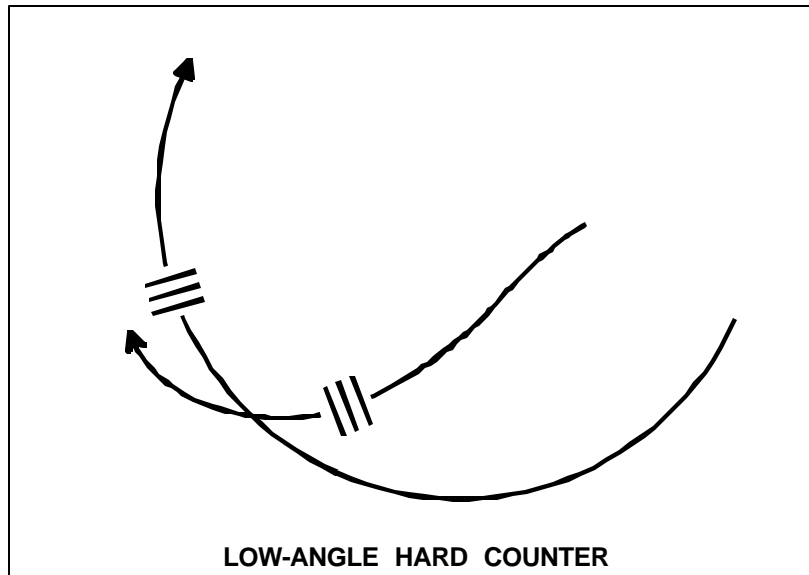

(b) Maximum instantaneous break turn: Lag to control zone via unload or easing of the g. Once AOT is manageable, bring nose to bear through superior turn rate. Low yo-yo may be required

Bandit: Assess fighter pursuit and either continue to pull in plane for maximum AOT, guns defense if required, reverse if appropriate, manage energy if fighter goes to immediate lag

Sg 2, fr 25

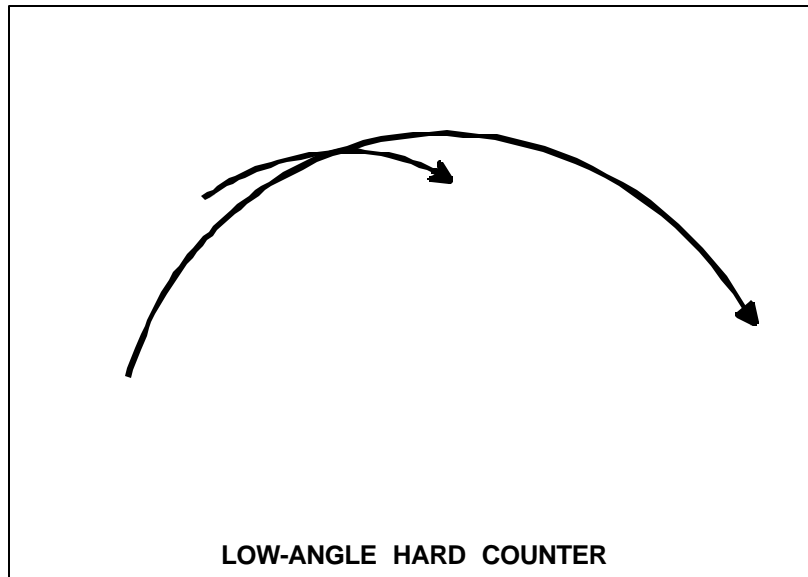

(3) Fighter: Kill him

3. Common errors:

a. Problem: Inappropriate pursuit given angles

Correction: Calibrate eye to recognize controllable angles which allow for immediate gunshot opportunities and those which will result in 3/9 line overshoots without a lag maneuver

b. Problem: Not maximum performing jet when in two-circle flow

Correction: Maintain at least 17 AOA when in target airspeed bandit. Do not bleed below 300 KIAS once deck prevents maintaining 17 units (15-16 units maximum sustainable)

c. Problem: Late recognition of bandit reversal, resulting in insufficient pre-circle transition and subsequent bandit bullets passing through student's cranium.

4. Follow-on

a. Should lag pursuit be excessive, it is possible to get stuck in either a lufbery or extended two-circle fight on the deck with minimal circle misalignment. Disengagement is an option if a quick kill cannot be achieved

b. Excessive lead could result in either a climbing pre-circle fight or, worse yet, a roller if there is a vertical component to the overshoot

Sg 2, fr 26 Choose from menu to show animation or diagrams and/or continue with the lesson.

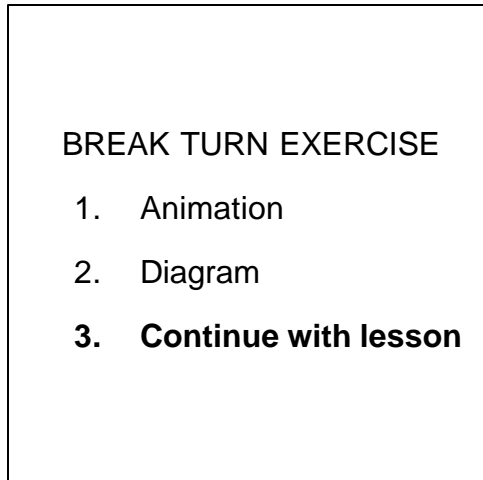

Animation (1)
Sg 2, fr 27

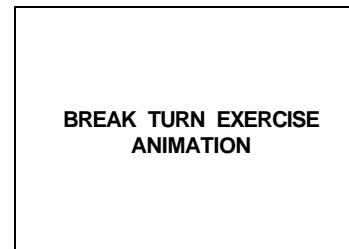
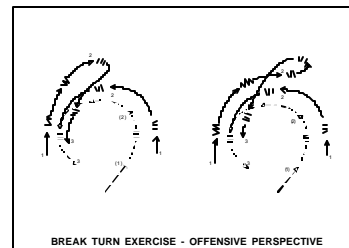

Diagram (2)
Sg 2, fr 29



G. Break turn exercise 6.7.3.2.8.1

1. Purpose: simulate section defeating long range missile shot while maneuvering to guns firing solution
2. Application
 - a. Setup
 - (1) 15-16,000 (fighter stepped up)/300 KIAS/combat spread
 - (2) Simulates bandit who launches missile from approximately 2 miles aft, between the section
 - b. Execution
 - (1) Wingman simulates missile defense
 - (a) Calls lead to break into missile
 - (b) Simultaneously pulls nose up 30 degrees and then slow rolls in lead's directions as lead executes a break turn into missile

(c) Calls lead to ease turn, simulating missile defeat

(2) Simulated counterattack [option](#)

NOTE: The lead now assumes the role of a passive bandit.

(a) Wingman continues roll, keeping bandit in sight

(b) Increases rate of roll, relaxes backstick pressure slightly to establish nose-low in the oblique, and ends up in nose-low slice turn in lag pursuit

(c) Maintains g until pure pursuit position for Fox-2

(3) Simulated counterattack—option 2

(a) Reverses turn nose-high prior to bandit passing underneath fighter resulting in monetary lost sight

(b) Overbanks aircraft to engage bandit in nose-low slice turn in lag pursuit

(c) Maintains 17 units AOA until reaching pure pursuit position (avoid heavy buffet)

(d) Maneuvers to Fox-2

Sg 2, fr 30

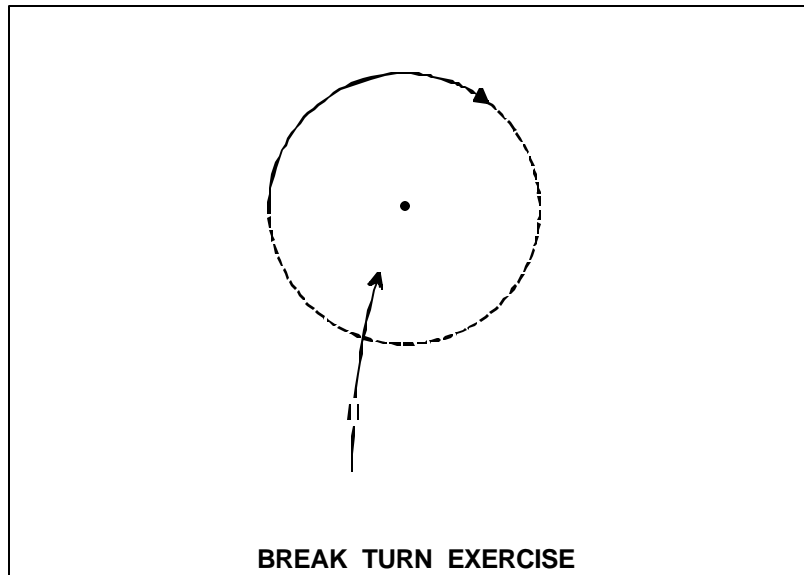

- (4) After FOX-2, begin unloaded straight line for bandit's post (as he executes breakturn back into fighter). Hold lag pursuit until penetrating bandit's bubble with max knots. There will be minimal line-of-sight (LOS) change from bandit until established within his turn circle

Sg 2, fr 31

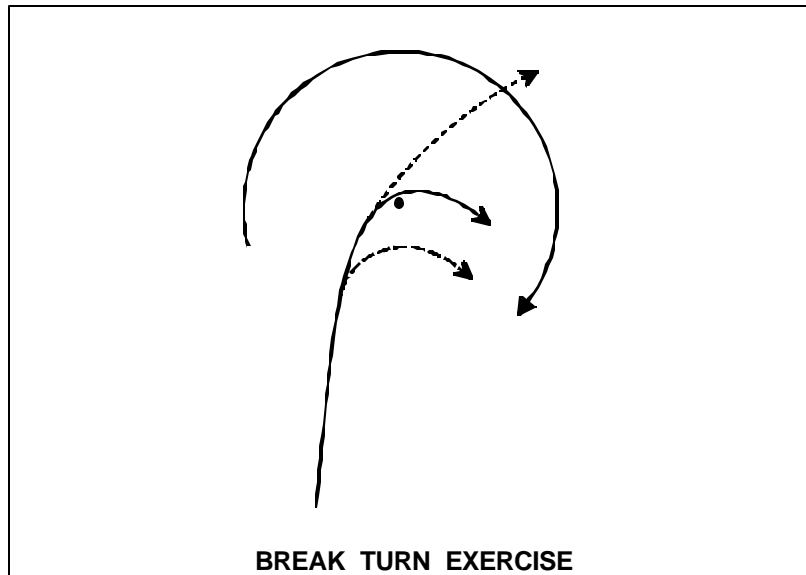

- (5) When LOS begins to increase rapidly, initiate a max performance pull around bandit's post to achieve control zone positioning. Bring nose to bear and shoot him! Follow-on lead to a tracking solution can now be initiated
- (6) If fighter buries his nose prior to initially bringing weapons to bear, bandit may elect to pitchback vertically. If this is the case, fighter should recognize changing post (closer to bandit as his airspeed decays in the vertical) and initiate appropriate pursuit curve. If bandit falls out of the fighter's POM, fighter should lead/pure pursuit bandit appropriately, until he has committed himself nose low. At this point, fighter should pull aggressive lead to bring nose to bear

3. Common errors

- a. Problem: rolling too slowly causing buried nose at bottom

Correction: increase roll rate enough to prevent burying nose

- b. Problem: early pull to lead

Correction: Wait until LOS picks up rapidly before transitioning to lead

- c. Problem: late pull to lead

Correction: At rapid LOS, max perform airplane to achieve control zone position

- d. Problem: excessive bandit extension leading to inability to reach post or, worse yet, a neutral merge

Correction: At exercise initiation, max perform jet to arrive nose on with minimal bandit separation

4. Follow-on—defensive pitchback **6.7.3.1.9**

- a. If unable to reach post prior to transitioning to lead/pure, bandit may elect to reverse. The fighter must anticipate this possibility and establish jet in appropriate parameters

- b. Excessive lag around the post could lead to a protracted two-circle fight without enough turn rate to get nose on, or an extension/pitchback out of the bandit and subsequent disengagement attempt

Sg 3, fr 1

ACM 1 v 1 OFFENSIVE MANEUVERING

- * Offensive concepts/tactics
- * Offensive maneuvers
- * **Disengagement/bugout**

III. Disengagement/bugout **6.7.3.1.10**

A. Offensive considerations

1. Aircraft problems
 - a. Mechanical problems
 - b. Guns misfire
 - c. Hung ordnance
2. Ordnance expended
3. Bingo/Joker fuel
4. Time-to-kill becomes factor

B. Procedures for execution **6.7.3.6.2**

1. Maintain sight of bandit and keep him at aft visibility limit
2. Reduce altitude to deck, if practicable, for terrain and weapons considerations

3. Attain high energy level as soon as possible after initiating bugout
4. Head for friendly territory when disengaging
5. Once disengaged, do not allow bandit to close without making positive defensive response

Sg 4, fr 1

ACM 1 v 1 OFFENSIVE MANEUVERING
REVIEW OPTIONS

1. Entire lesson
2. Offensive concepts/tactics
3. Offensive maneuvers
4. End this lesson

Please select

SUMMARY

This lesson focused on the offensive aspect of the air combat arena including:

- * Offensive [concepts/tactics](#)
- * Snap guns exercise
- * High yo-yo
- * Low yo-yo
- * Horizontal scissors
- * Rolling scissors
- * [Low-angle hard counter](#)
- * Break turn exercise
- * Disengagement

CONCLUSION

Good fighter pilots must have this one outstanding trait—aggressiveness. Remember, the fighter pilot who wins is the pilot who makes the fewest mistakes.

FLIGHT SUPPORT LECTURE GUIDE

COURSE/STAGE: T-45A UJPT, ADV, & IUT Air Combat Maneuvering

LESSON TITLE: ACM 1 v 1 Defensive Maneuvering

LESSON IDENTIFIER: T-45A UJPT, ADV, & IUT ACMFP-03

LEARNING ENVIRONMENT: Classroom

ALLOTTED LESSON TIME: 1.0 hr

TRAINING AIDS:

- * ACMFP CD-ROM
- * T-45 Scale Models

STUDY RESOURCES:

- * T-45A NATOPS Flight Manual, A1-T45AB-NFM-000
- * Air Combat Maneuvering Flight Training Instruction (FTI)

LESSON PREPARATION:

Read:

- * T-45A ACM FTI "Defensive Maneuvering Flight Procedures" section

REINFORCEMENT: N/A

EXAMINATION:

The objectives in this lesson will be tested in ACMFP-05X.

(10-98) ORIGINAL

THIS PAGE INTENTIONALLY LEFT BLANK.

LESSON OBJECTIVES**6.7.3.3.1**

Recall the concepts and tactics applicable to defensive ACM

6.7.3.6.1

Recall factors/techniques for defensive disengagement

6.7.3.6.3

Recall disengagement follow-on options

6.7.3.3.9

Recall the purpose and application of the snap guns exercise in ACM (defensive)

6.7.3.4.8.1

Recall the procedure for performing the snap guns exercise (defensive)

6.7.3.3.3

Recall the purpose and application of the horizontal scissors (defensive)

6.7.3.4.3.1

Recall procedure for performing horizontal scissors (defensive)

6.7.3.3.4

Recall the purpose and application of the rolling scissors (defensive)

6.7.3.4.4.1

Recall procedure for performing rolling scissors (defensive)

6.7.3.4.5.1

Recall purpose and application of defensive low-angle to hard counter

6.7.3.4.5.2

Recall procedures for performing a defensive low-angle to hard counter

6.7.3.4.10.2

Recall purpose and application for break turn exercise (defensive)

6.7.3.4.10.1

Recall procedure for the “break turn” exercise (defensive)

6.7.3.3.5

Recall the purpose and application of the lufbery

6.7.3.3.6

Recall the purpose and application of the diving spiral

6.7.3.4.6.1

Recall procedure for performing a diving spiral

6.7.3.3.7

Recall the purpose and application of the high “g” roll

6.7.3.4.7.1

Recall the procedure for performing a high “g” roll

6.7.3.3.8

Recall the purpose and application of jink-out maneuvers

6.7.3.3.8.1

Recall procedures for performing jink-out maneuvers

MOTIVATION

If the motto for TOPGUN, “You fight like you train,” holds true, being aggressive and persevering is essential to reaching the main goal of defensive maneuvering--survive to fight another day.

Since you’re involved in combat not just to save your skin, but to win, learn how to put the other guy on the run.

OVERVIEW

This lesson will enable you to perform the procedures for defensive maneuvering in the ACM environment.

This lesson covers defensive aspects of the following:

- * Concepts and tactics
- * Snap guns exercise
- * Horizontal scissors
- * Rolling scissors
- * Low-angle hard counter
- * Break turn exercise
- * Lufbery
- * Diving spiral
- * High-g roll
- * Jink-out

REFRESHER

Review the procedures covered in ACMFP-01 and ACMFP-02.

Sg 1, fr 1

ACM 1 v 1 DEFENSIVE MANEUVERING

- * **Defensive concepts/tactics**
- * Defensive maneuvers
- * Last ditch maneuvers

PRESENTATION

I. Defensive concepts/tactics **6.7.3.3.1, 6.7.3.6.1, 6.7.3.6.3**

A. Priorities

1. Survive

- a. Maximize AOT by keeping lift vector on, in-plane when two-circle
- b. If nose comes to bear, defeat missile with maximum instantaneous break turn
- c. If bandit satisfies lead, range and POM, defeat gunshot by maneuvering perpendicular to destroy POM. After defeating gun threat, continue to pull in plane with bandit and look for reversal opportunity

Sg 1, fr 2

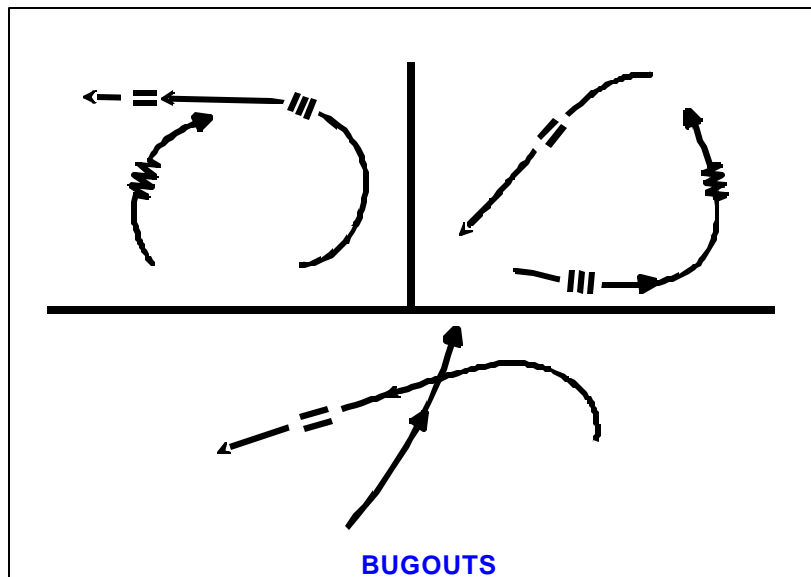

2. Bugout

- a. Maximize AOT, look for reversal opportunities
- b. Reverse only if you can force the bandit into the forward quarter
- c. Bandit overshoots of fighter's flight path should be assessed for unload opportunities (manage energy for best sustained rate if continuing two-circle)
- d. Misaligned circles in two-circle flow lead to merges which may offer bugout or extension/pitchback possibilities
- e. Look for maximum AOT, minimum lateral separation, and maximum knots to successfully disengage
- f. DO NOT lose sight. Check turn as required on bugs to keep sight

3. Reverse roles

- a. If the bandit is stupid enough to fly out in front of you, he's probably better off dead. However, if you can't get a quick kill, consider it a sign from God, and run away

Sg 2, fr 1

ACM 1 v 1 DEFENSIVE MANEUVERING

- * Defensive concepts/tactics
- * **Defensive maneuvers**
- * Last ditch maneuvers

II. Defensive maneuvers

NOTE: In this lesson, defensive maneuvers are viewed from the defender's perspective. Therefore, the defender is the "fighter" and the attacker is the "bandit." The associated diagrams are labelled "defender" and "attacker" according to aircraft position in the fight, not according to role.

A. Snap guns exercise **6.7.3.3.9**

1. Purpose: practice defending against high angle-off guns attack while maintaining sufficient energy to counter next attack

Sg 2, fr 2 Choose from menu to show animation or diagram and/or continue with the lesson.

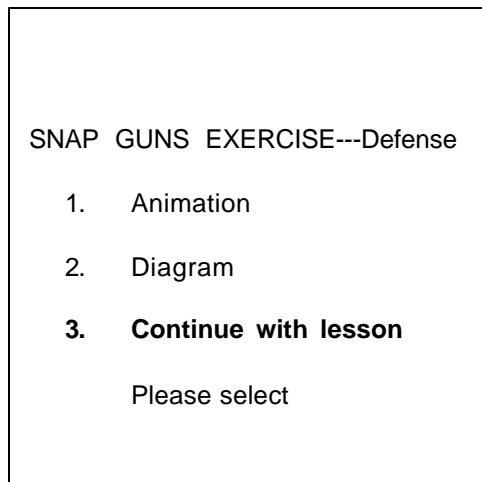

Animation (1)
Sg 2, fr 3

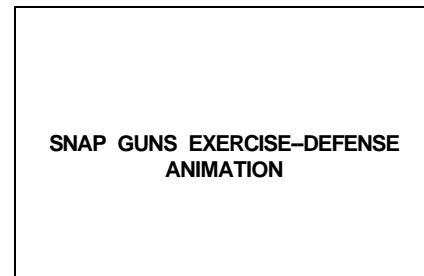
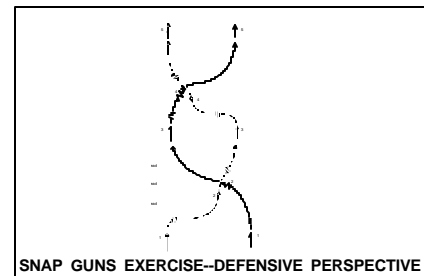

Diagram (2)
Sg 2, fr 5

Also may
use T-45
Scale Model



2. Application

LESSON NOTES

Whenever a topic is supported by both a screen projection and animated video, you will have a menu. You cannot stop the animation once it has begun to play. Choosing "Animation" will display the first frame of the animation. Select "MORE" to start the animation or "NAVIGATE" to return to the menu. Choosing "Diagram" will call up the screen projection, which will be a ribbon diagram or spaghetti diagram of the maneuver. Use your own discretion as to which you show first, and continue the lesson by choosing "Continue" at the end of the menu.

- a. Setup: level combat spread
- b. Execution **6.7.3.4.8.1**
 - (1) Bandit calls "In as the shooter" and hard turns into attack

- (2) Fighter calls "In as the target" and turns with 45-60 degree AOB into attack
- (3) Bandit reverses as fighter approaches 10/2 o'clock to achieve a snap guns solution of 60-90 degrees AOT
- (4) Fighter
 - (a) Reduce planform by breaking out-of-plane and pulling hard to avoid bandit's pipper, prior to bandit's nose coming on
 - (b) Maintains sufficient closure rate to force overshoot

3. Common errors

- a. Problem: continuing to pull in-plane with bandit allowing greater shot opportunities

Prevention: maneuver aggressively out-of-plane

- b. Problem: allowing bandit to position nose on fighter prior to maneuvering out-of-plane

Prevention: recognize bandit's nose position and anticipate maneuver

- c. Problem: initiating an out-of-plane maneuver too early

Prevention: generate sufficient angles/closure to force an overshoot prior to out-of-plane maneuvering

Sg 2, fr 6

HORIZONTAL SCISSORS---Defense

1. Animation
2. Diagram
3. **Continue with lesson**

Please select

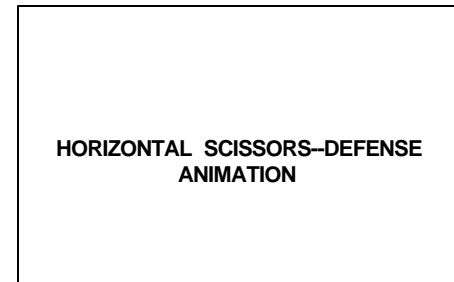
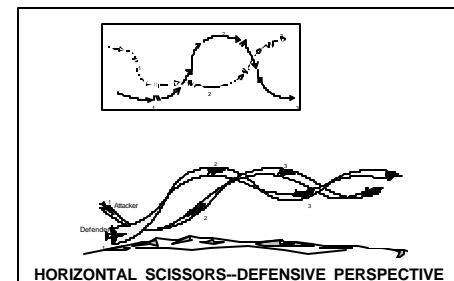
Animation (1)
Sg 2, fr 7*Diagram (2)*
Sg 2, fr 9**B. Horizontal scissors 6.7.3.3.3**

1. Purpose: to exploit an in-close horizontal overshoot
2. Application
 - a. Setup: 14/14,000 ft/250 KIAS/combat spread
 - b. Execution **6.7.3.4.3.1**
 - (1) Allow bandit to maneuver into a 60-90 degree AOT snapshot envelope and aggressively pull out-of-plane prior to a valid shot. Continue to pull nose up and reverse as bandit overshoots your flight path
 - (2) The reversal should be such that the fighter's lift vector is aggressively positioned aft of the bandit as nose is initially brought 60-70 degrees nose high. Gradually allow nose to come down and AOB to decrease as fighter establishes an airspeed which will minimize turn radius
 - (3) Fighter must continue to maneuver so as to keep the bandit in the forward quarter whenever his nose comes to bear. If the bandit is able to come nose on aft of the

fighter's wingline, a nose-low redefinition must occur. Ideally, the fighter will force relatively neutral merges, delaying reversals as long as possible to drive his own turn circle away from the bandit's, allowing the fight to assume the characteristics of two-circle flow

- (4) As the scissors widens, the fighter may be able to unload for a second or two at the merge, meeting the bandit with an ever-growing bag of knots. At some point (preferably 180 degrees out with something greater than 200-220 kts), a disengagement can be attempted. If the attempt is made with the bandit potentially belly-up in his reversal, his late recognition of a fighter bug attempt may facilitate its success
- (5) As the bugout is attempted, the fighter has to keep sight of the bandit. A series of check turns followed by 0-g unloads will maximize extension. The ultimate call as to the success of the disengagement has got to be made by the fighter, needless to say

3. Common errors

- a. Problem: Asking too much of the jet when at slow airspeed, high AOA leading to inability to control turn circle

Correction: Coordinate stick/rudder and shoot for an airspeed which is controllable (130-150 KIAS works well).

- b. Problem: Not recognizing a bandit who is bringing nose to bear behind fighter's wingline and reversing when there is no overshoot.

Correction: Remember what a valid snapshot looks like from the Snapshot drill. If you see this same sight picture at 150 kts and negligible TCR, redefine the fight!

- c. Problem: Poor bugout timing or poor technique

Correction: Fighter should not attempt a disengagement unless he can get at least 150 degrees AOT and then must go immediately to 0 g while check turning as required to keep bandit near aft visibility limit.

4. Follow-on

- a. Should a two-circle redefinition be necessary, a tight, spiraling fight may result. Fighter must assess bandit's pursuit curve and react accordingly. If he's pulling lead for a shot, a nose-high defense may well send the bandit into the deck. If bandit goes into lag, the fighter must pick up an airspeed/AOA combination to maximize turn rate while avoiding the rocks.
- b. If a bugout attempt is unsuccessful, the fighter must initiate a pitchback to maximize AOT prior to the bandit bringing the nose to bear. The range and nose attitude of the bandit will dictate the nature of the fighter's pitchback

C. Rolling scissors 6.7.3.3.4

1. Purpose

- a. To exploit in-close horizontal and vertical overshoot
- b. To force opponent out in front by reducing forward vector

Sg 2, fr 10 Choose from menu to show animation or diagram and/or continue with the lesson.

ROLLING SCISSORS---Defense

1. Animation
2. Diagram
3. **Continue with lesson**

Please select

Animation (1)
Sg 2, fr 11

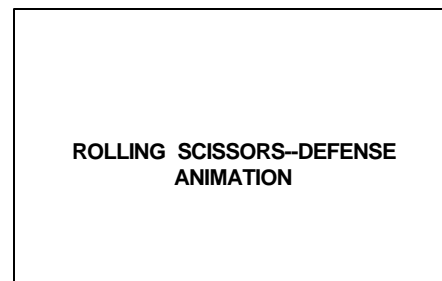
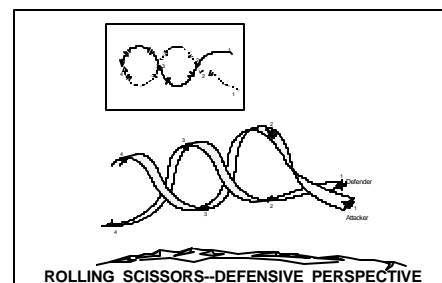

Diagram (2)
Sg 2, fr 13



2. Application

- a. Setup: 15-16,000 ft (fighter low)/250 KIAS/0.5 nm/60-70 degrees AOT
- b. Execution 6.7.3.4.4.1
 - (1) As bandit attempts barrel roll attack, execute slightly nose-low hard defensive counter turn into bandit
 - (2) Maintain turn until bandit crosses on top of your flight path

- (3) At moment of overshoot, commence defensive pitchup
 - (a) Level wings
 - (b) Keep 17 units AOA
 - (c) Execute vertical pitchup to approximately 60 degrees nose-high
- (4) As energy dissipates, commence roll-off (barrel roll) using aileron and rudder to complete roll
- (5) Once nose-high attitude established by fighter
 - (a) Pull for horizontal overshoot on top
 - (b) Maintain nose above horizon until commencing follow on rolls to avoid burying nose

NOTE: The remainder of the procedures identical to rolling scissors procedure appear in the offensive lesson ACMFP-02.

c. Termination

- (1) Reason—lack of altitude
- (2) Reaction
 - (a) Flatten rolling scissors (shorten vertical separation)
 - (b) Convert into horizontal scissors
 - (c) Disengage

3. Common errors

- a. Problem: allowing bandit to pull behind 3/9 line caused by a weak nose-low hard counterturn in horizontal

Prevention: pull aggressively in the horizontal to force overshoot

- b. Problem: allowing bandit to generate excessive nose-to-tail separation caused by a delayed or weak initial pull into vertical

Prevention: pull aggressively into vertical to force overshoot

- c. Problem: reversing in opposite direction of horizontal overshoot

Prevention: recognize direction of horizontal overshoot

NOTE: Other common errors that are identical to offensive and defensive position are included in offensive lesson—ACMFP-02.

4. Follow-on

- a. Conversion to flattened rolling scissors—occurs when pressing to become offensive but run out of altitude to continue offensive pursuit

NOTE: Flattening the rolling scissors will work to the fighter's advantage only if the fighter's energy state is at least equal to the bandit's. If bandit's energy state is greater, the bandit can generate sufficient vertical displacement for his subsequent rolls, i.e., he will not be flattening his scissors, and therefore forcing the fighter farther in front.

(1) Continue roll through

(2) Put lift vector in front of bandit to shallow slice turn and miss deck. If bandit rolls through without being aware of altitude problem, bandit is scraped off

(a) If bandit rolls through without being aware of altitude problem, bandit is scraped off

(b) If bandit aware of altitude and your tactic, bandit forced to put lift vector in front resulting in reordering relative geometry

b. Conversion to horizontal scissors

NOTE: About 2,500 ft above the hard deck is needed for a successful nose-low roll through the vertical to continue the rolling scissors.

- (1) Fighter/bandit at top of roller will remain nose-high and continue to pull back toward bandit/fighter to generate overshoot
- (2) Instead of rolling through vertical, aircraft on top will reverse nose-high and pull back toward aircraft beginning vertical pullup resulting in horizontal scissors

c. Disengagement from top of roller

NOTE: The opportune bugout time occurs when the bandit is going up and the fighter is going down.

- (1) Ensure bandit's noseup attitude
- (2) Instead of performing roll
 - (a) Continue pull to nose-low attitude generating maximum AOT and minimum lateral separation
 - (b) Unload toward bandit's extended 6
 - (c) Disengage and bug out

Sg 2, fr 14

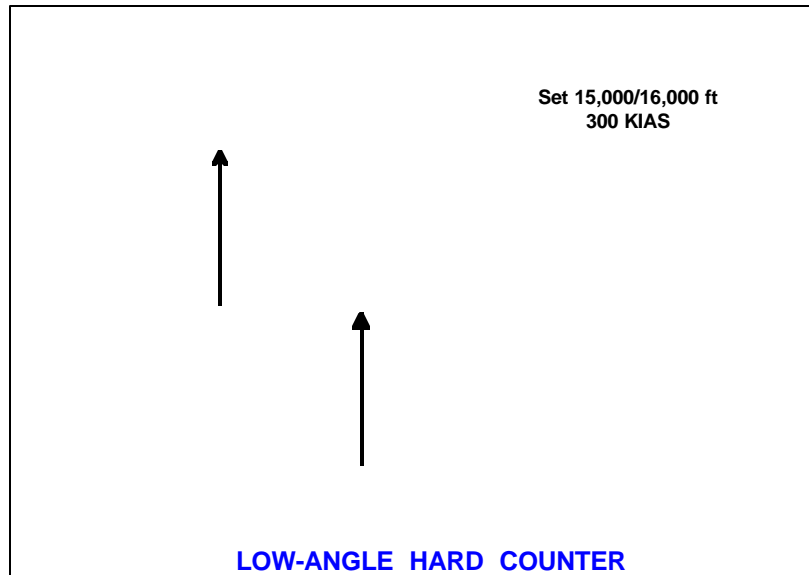

D. Low angle hard counter 6.7.3.4.5.1

1. Purpose: Survive a highly threatening bandit near fighter's control zone
2. Applicability
 - a. Setup: 15-16,000 ft (fighter low)/300 KIAS/bandit perched 40 degrees AOT

Sg 2, fr 15

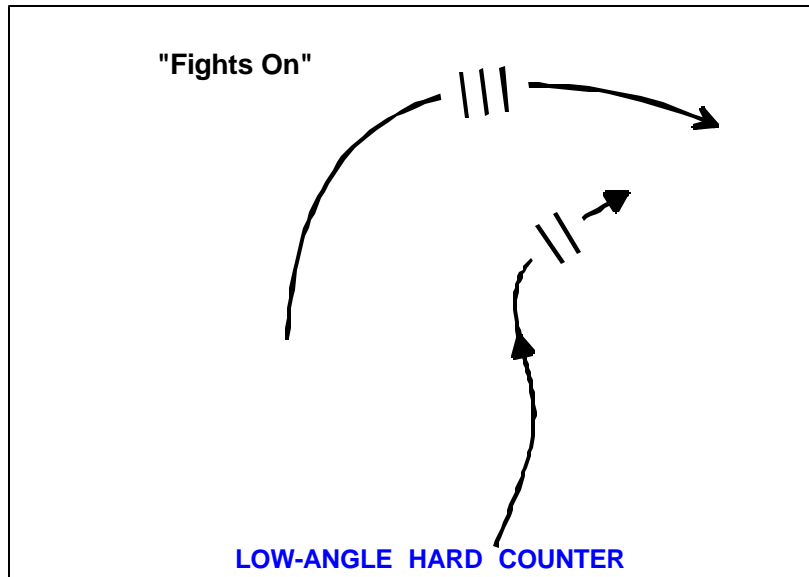

b. Execution: 6.7.3.4.5.2

- (1) At "fight's on," initiate a maximum instantaneous break turn to defeat bandit missile

Sg 2, fr 16

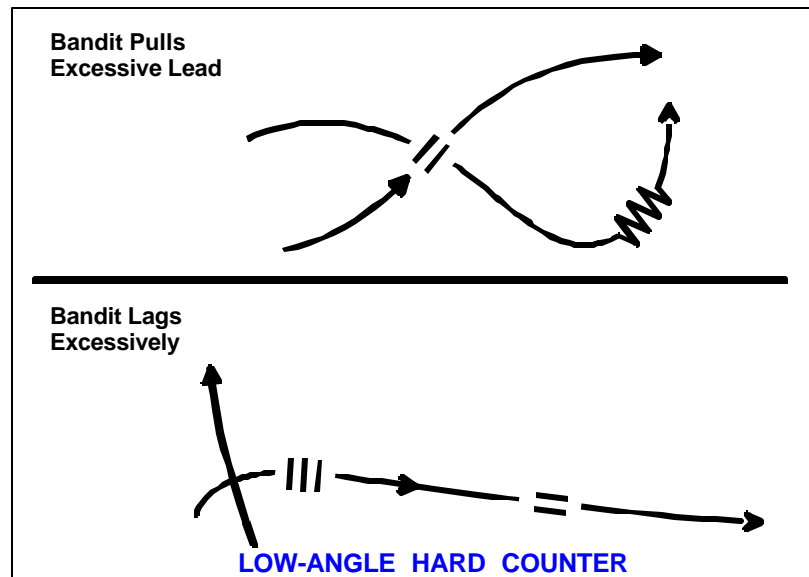

- (2) Continue break turn as you assess bandit's pursuit. If bandit pulls lead, continue to generate angles, executing guns defense when appropriate. If bandit overshoots in close with a high TCR, execute a maximum performance nose-high reversal to swing the bandit into the forward quarter. Trade airspeed for altitude/position advantage and look for disengagement opportunities off subsequent flat scissors
- (3) If bandit overshoots in close and sufficient vertical separation exists after fighter reversal, roll over the top to capitalize on turning room and look for bugout opportunities
- (4) If bandit moves to lag and attempts control zone positioning, the fighter must evaluate his own energy state—sustained turn rate will determine whether the bandit is able to bring his nose to bear. If there is an opportunity to unload for knots while bandit's nose is off, this may provide fighter with a more survivable energy package. If there isn't an opportunity to unload, the fighter will at least need to come off maximum instantaneous turn and continue a 17-unit pull

- (5) The bandit may attempt to convert altitude below into increased turn rate through the use of a low yo-yo. When the fighter recognizes this, he needs to match the bandit nose-low-to-counter
- (6) If the bandit is able to get the nose on following initial move, the fighter must defend against the shot. Aggressively pulling nose high out of plane from a bandit shooting a maximum range snapshot will destroy fighter's hopes of keeping the bandit out of the control zone. However, as the bandit holds the pipper on and range decreases, the lethality of the shot increases dramatically and a more aggressive guns defense will be required. Again, an overly aggressive bandit may drive himself into a reversible overshoot affording fighter possible bug opportunity

3. Common errors

- a. Problem: Not generating maximum instantaneous turn rate off initial break turn allowing bandit the luxury of gunning his brains out with no adverse consequences

Correction: At 300 KIAS, maximum instantaneous turn rate is achieved through a 19-21 unit pull. Maintaining 300 KIAS will require at least 30 degrees nose low in the break turn

- b. Problem: Losing sight of bandit during bandit lag

Correction: Don't lose sight

- c. Problem: Bleeding below 300 KIAS during pull

Correction: Cross-check airspeed off HUD if required, but don't bleed. Below 300 KIAS, turn rate falls off a cliff

- d. Problem: Busting deck while looking aft

Correction: A rocks kill is just as lethal as soaking up a missile. The fighter must have a deck transition plan that allows for a smooth transition to maximum sustained turn rate (approximately 15-16 units at 300 KIAS).

4. Follow-on

- a. If an opportunity presents itself to reverse, a disengagement opportunity may present itself.
- b. If the bandit achieves a tracking solution, fighter must keep working out-of-plane to destroy bandit solution. An aggressive bandit may well be slow to recognize closure from an airspeed differential, resulting in an in-close overshoot

E. Break turn exercise, 6.7.3.4.10.2

1. Purpose—practice defensive maneuvering against long range missile shot and guns firing solution

Choose from menu to show animation or diagram and/or continue with the lesson.
Sg 2, fr 17

BREAK TURN EXERCISE---Defense

1. Animation
2. Diagram
3. **Continue with lesson**

Please select

Animation (1)
Sg 2, fr 18

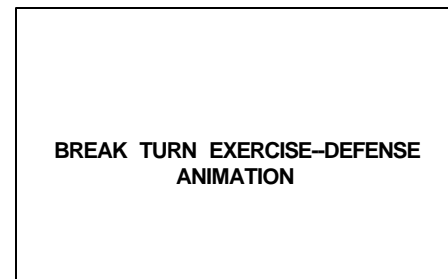
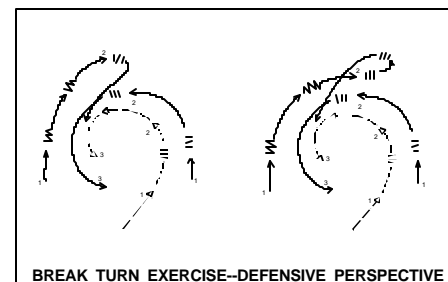

Diagram (2)
Sg 2, fr 20



2. Application

- a. Setup

-
-
- (1) Section in combat spread
 - (2) Simulated bandit attacking from 6 between section, spotted by lead (IP)
- b. Execution **6.7.3.4.10.1**
- (1) Lead
 - (a) Calls wingman to break into missile
 - (b) Simultaneously initiates nose-high roll into wingman
 - (c) Calls wingman to ease turn as he reaches 45 degrees of turn (simulating missile defeat)
 - (2) Wingman:
 - (a) Responds with a 19-21 unit AOA break turn into the simulated missile
 - (b) Becomes defensive fighter
 - (c) Continue break turn until pulling bandit to aft visibility limit, then start an unload to maximize nose-to-tail separation
 - (d) BEFORE bandit brings nose to bear, execute maximum instantaneous turn into bandit. Max g available should be held until reaching target airspeed band when 17 units will maximize sustained turn rate

Sg 2, fr 21

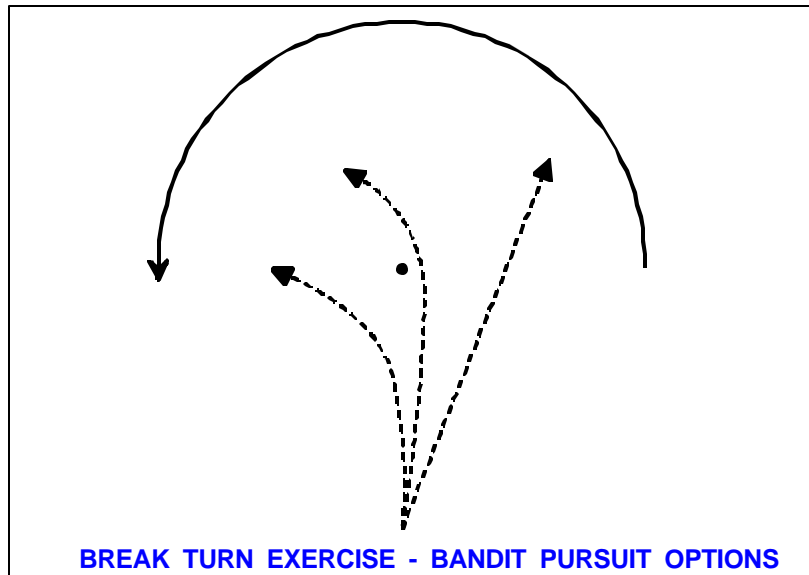

- (e) If bandit pulls lead ahead of fighter's post, a reversal may position fighter for a disengagement. Similarly, if fighter can achieve a neutral pass with the bandit, a bugout may well be successful
- (f) If the bandit lags excessively, extend and attempt a reversal nose low in plane with the bandit. Range may allow a second merge closer to neutral and another bugout opportunity
- (g) A well-executed lag move around fighter's post will require careful energy management from the fighter to survive
- (h) If the bandit's nose gets buried off the initial move, a vertical move may allow the fighter to hold the bandit's nose off. However, range should be the overriding consideration since a savvy bandit can counter a vertical pitchback fairly easily
- (i) The key to successfully disengaging from the bandit off a vertical pitchback is first, timing. At the point the bandit's nose reaches its lowest point, the fighter needs to execute his wings level, 17-unit pull into the vertical. This concept is known as "opposing the nose" and, if executed properly, will give the bandit the furthest distance to pull the nose before

he can bring the nose to bear. However, the fighter must roll the jet into the bandit's POM upon reaching the pure vertical and attempt to achieve a neutral high-to-low merge and subsequent disengagement. As you might recall from the Offensive section, this pitchback can be fairly easily countered

(3) Lead: becomes offensive bandit--calls "Fox-2"

(4) Fighter

(a) Executes second break turn

(b) Continues pull until bandit acquired

(c) Defends against high and low yo-yos

3. Common errors

- a. Problem: Not putting the bandit at the aft visibility on the initial extension

Correction: Continue pulling until the bandit is just off the tail before attempting an extension

- b. Problem: Other than a 0-g unload, missing chance to acquire maximum energy

Correction: Push on the stick to 5 units or a "light in the seat" feel

- c. Problem: Hitting the deck on either the unload or the pitchback

Correction: Keep the deck in your scan

Sg 2, fr 22

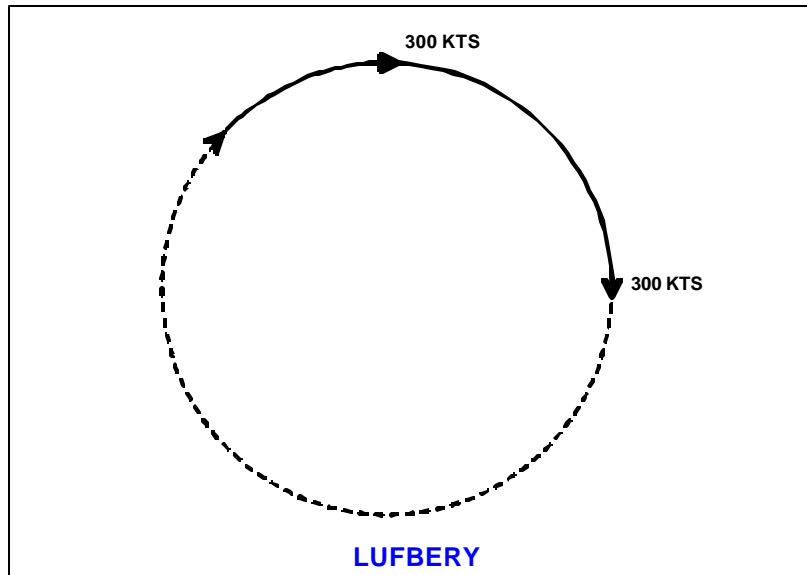

F. Lufbery 6.7.3.3.5

1. Description
 - a. Results from neutral situation or one developing from defensive situation against similar performance bandit
 - b. Considered a stalemate
2. Disengagement—especially in low-altitude situation

NOTE: This disengagement maneuver requires a great amount of time and fuel. Normally during your syllabus flights, the lufbery will be terminated early.

NOTE: A one-move disengagement should not be performed as the lateral separation and AOT are usually not great enough to prevent the bandit from gaining the advantage.

- a. Begin series of unloads and pullbacks to gain airspeed and nose-to-tail separation
 - (1) Reduce AOA momentarily, to an unloaded condition
 - (2) Maintain AOB to disguise extension maneuver

(3) Pull back into bandit to stabilize AOT

- b. With sufficient airspeed and nose-to-tail separation, execute bugout or defensive pitchback
- c. If disengagement is unsuccessful, then another guns defense maneuver can ensue

Sg 3, fr 1

ACM 1 v 1 DEFENSIVE MANEUVERING

- * Defensive concepts/tactics
- * Defensive maneuvers
- * **Last ditch maneuvers**

III. Last-ditch maneuvers

NOTE: Last-ditch maneuvers should only be employed as a last resort to defeat a shot by the bandit.

A. Defensive diving spiral **6.7.3.3.6**

NOTE: A diving spiral is essentially a tight two-circle fight extremely nose-low. (Two-circle fights are explained in neutral starts.)

1. Purpose

- a. Counter in-close, medium-to-low angle off gun attack while retaining maneuvering potential
- b. Offers escape opportunity
- c. Drive bandit into deck

Sg 3, fr 2 Choose from menu to show animation or diagram and/or continue with the lesson.

DIVING SPIRAL

1. Animation
2. Diagram
3. **Continue with lesson**

Please select

Animation (1)
Sg 3, fr 3



Diagram (2)
Sg 3, fr 5

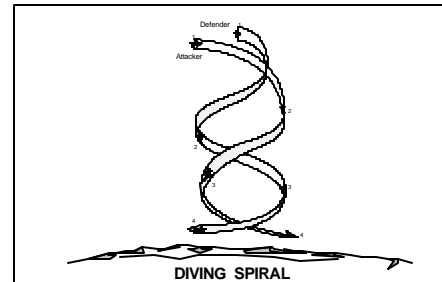

2. Application

- a. Setup: bandit nears gun employment position and fighter's hard or break turn proves ineffective
- b. Conditions
 - (1) Sufficient altitude (10,000 ft above deck)
 - (2) Cooperative bandit (follow into spiral)
 - (3) Max deceleration (power/speed brakes)
- c. Execution—fighter **6.7.3.4.6.1**

CAUTION: Descent rates in excess of 30,000 fpm may occur. Late pullout must be avoided, especially if padlocked on a bandit in the rear quadrant. Typically 8,000 plus ft of altitude loss per 360 degrees of turn can be expected. Be aware of deck proximity.

- (1) Executing spiral
 - (a) Continue hard turn into bandit, over-bank utilizing aileron and rudder to place lift vector on bandit

(b) Use aileron and rudder to roll aircraft to maintain lift vector on the bandit throughout spiral

(2) Pullout of maneuver

CAUTION: Begin pullout prior to 1,500-3,000 ft above the deck, depending on nose attitude.

(a) If bandit begins pullout first, roll aircraft about own axis and gain angles on bandit

(b) If bandit doesn't pull out earlier, judge own successful pullout above deck so as to force bandit into deck

(c) If spiral fairly even, exit by leveling wings and pulling out at max power and best AOA, without accelerated stall or overstress (this will depend on airspeed--approximately 14-18 units)

d. Common errors

(1) Problem: highlighting initial move, allowing bandit to delay committing his nose

Prevention: bait bandit into committing his nose-low by initially lowering nose slightly, prior to entering excessive nose-low attitude

(2) Problem: delaying pullout to avoid deck

Prevention: monitor altitude and time pullout

e. Variation: if bandit overshoots vertically in spiral, maintain offensive advantage and be aware of deck

B. High-g roll **6.7.3.3.7**

1. Purpose

a. Use against low angle off attack, when bandit at close range, to force overshoot by quickly reducing velocity vector (maximum deceleration)

- b. Make tracking difficult due to dramatic changes in three axes (pitch, yaw, roll) and increase in closure
- c. Spit bandit to outside resulting in a possible neutral scissors

NOTE: Maneuver involves uncoordinated flight techniques (snap roll), power reduction, and drag increase (parasite and induced) as available in order to increase bandit's closure.

Sg 3, fr 6

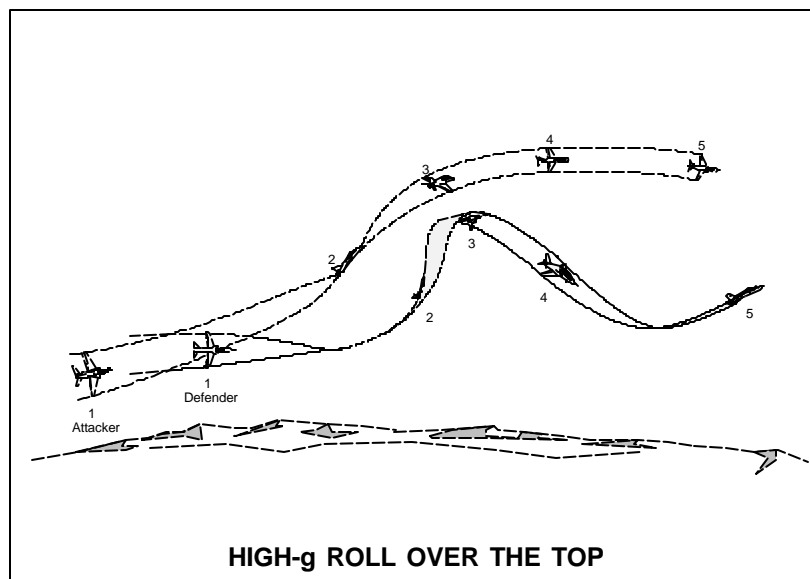

- 2. Over the top
 - a. Setup—speed is greater than 275 KIAS and bandit within 1,500 ft
 - b. Execution—fighter **6.7.3.4.7.1**
 - (1) From hard turn, increase back pressure to force overshooting situation
 - (2) Reduce power and extend speed brakes while keeping back stick pressure

- (3) Roll opposite to plane of attack (initiated with ailerons but continued with fully deflected rudder)
 - (4) While inverted in roll
 - (a) Increase rate of roll
 - (b) Continue back pressure
 - (c) Continue rudder use to keep nose from getting too low
 - (5) At 270 degrees into roll, continue to play top rudder to control nose and check opponent
 - (6) Recover nose-high into bandit by retracting speed brakes and adding max power
- c. Advantage: usually results in greater overshoot, possibly allowing fighter to gain offensive position by reversing back toward bandit as overshoot occurs
- d. Disadvantage: causes greater speed and energy loss

NOTE: If the high-g roll over the top is begun at too low a speed, it may leave the fighter too slow and unmaneuverable on top, thus unable to successfully complete the maneuver and avoid a close-range snapshot.

Sg 3, fr 7

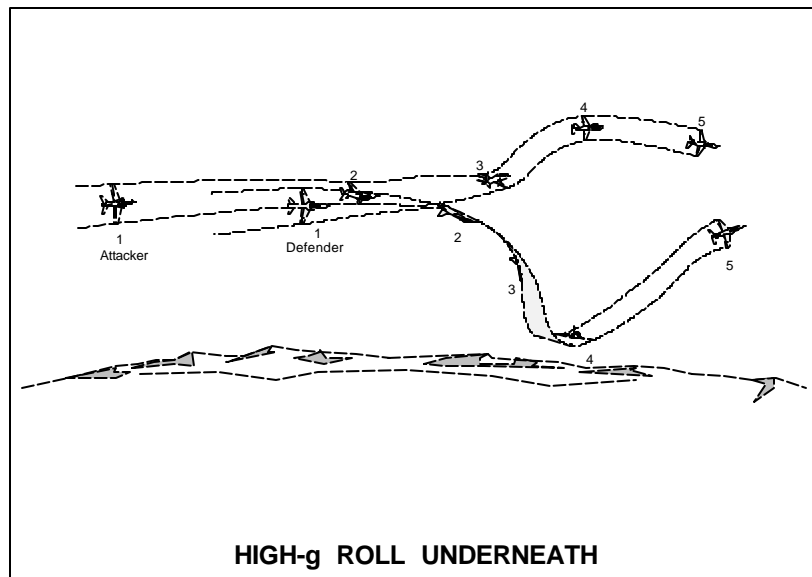

3. Underneath

- a. Setup—roll underneath if speed is less than 275 KIAS, altitude is at least 2,000 ft above deck, and bandit within 1,500 ft
- b. Execution—fighter
 - (1) Continue hard pull in defensive turn until bandit is at highest possible angle off, then pull to buffet
 - (2) Start rolling underneath into direction of defensive turn—use full bottom rudder to roll
 - (3) Reduce power, extend speed brakes to increase closure, maintain neutral ailerons
 - (4) Using rudder, but not ailerons, roll below bandit's projected flight path in same direction of turn
 - (5) Maintain rudder in direction of turn throughout roll, along with back pressure on stick
 - (6) When lift vector starts above horizon (halfway through the roll), maintain 19-20 units AOA while adding full power and retracting speed brakes

-
-
- (7) Continue roll to wings level
 - (8) Neutralize rudder to stop roll, maintain back stick to achieve nose-high attitude
 - (9) Check for bandit's position
- c. Advantages
 - (1) Gravity assists in early stages
 - (2) Reduces speed loss during maneuver—possibly providing better maneuverability
 - d. Disadvantage: results in considerable loss of altitude
4. Common errors
- a. Problem: failing to force bandit into overshoot

Prevention: increase closure and AOT with break turn and reduce power
 - b. Problem: failing to maintain loaded-up condition resulting in flat or extremely nose-low situation

Prevention: keep aircraft loaded up throughout roll
5. Variations
- a. If bandit overshoots outside radius of turn, then continue to pull up and into bandit in order to
 - (1) Increase AOT
 - (2) Force bandit into horizontal scissors
 - (3) Look for opportunities to disengage
 - b. If bandit inside radius of turn, then continue max performance turn into bandit and attempt another maneuver

C. Jink-out, **6.7.3.3.8**

1. Purpose

- a. Destroy gun solution while maneuvering to out-of-phase situation
- b. Retain potential to neutralize follow-on or seek disengagement

2. Application

- a. Setup: bandit approaches medium-to-low angle off, in-close, firing cone
- b. Execution, **6.7.3.3.8.1**

- (1) Increase turn to create overshoot
- (2) Assuming overshoot does not occur and bandit begins to pull lead
 - (a) Apply negative g to push aircraft out of bandit's predicted guns tracking solution

WARNING: Due to the risk of structural damage to the aircraft, negative g should be limited to one negative g in training. In combat, maximum negative g available can be used.

- (b) Maintain negative g for approximately 2 sec
- (c) Establish positive-g break turn for 2-4 sec back into bandit's position
- (d) Establish out-of-phase overshoot by maximum rate of roll reversal and positive-g turn

c. Common error

- (1) Problem: not unloading aircraft to a negative-g situation

Prevention: ensure unload is at least one negative g (limit to one g in training), practice and acquire a feel for negative-g flight

- d. Variation—out-of-phase overshoot occurs
 - (1) If insufficient angle off and lateral separation occur, then use rolling reversal
 - (2) If initially you have greater amount of angle off and lateral separation, then use connecting maneuver such as diving spiral or maneuver for airspeed and lateral separation

Sg 4, fr 1

ACM 1 v 1 DEFENSIVE MANEUVERING

REVIEW OPTIONS

1. Defensive maneuvers
2. Last ditch maneuvers
3. End this lesson

Please select

SUMMARY

This lesson covered the defensive aspects of the following:

- * Concepts and tactics
- * Snap guns exercise
- * Horizontal scissors
- * Rolling scissors
- * Low angle hard counter
- * Break turn exercise
- * Lufbery
- * Diving spiral
- * High-g roll
- * Jink-out

CONCLUSION

You've learned maneuvers for creating overshoots and staying out-of-phase to save your skin and to put the other guy on the run in 1 v 1 air combat maneuvering. You've taken another step toward becoming an ace.

NOTES

FLIGHT SUPPORT LECTURE GUIDE

COURSE/STAGE: T-45A UJPT, ADV & IUT Air Combat Maneuvering

LESSON TITLE: ACM 1 v 1 Neutral Starts

LESSON IDENTIFIER: T-45A UJPT, ADV & IUT ACMFP-04

LEARNING ENVIRONMENT: Classroom

ALLOTTED LESSON TIME: 0.8 hr

TRAINING AIDS:

- * ACMFP CD-ROM
- * T-45 Scale Model

STUDY RESOURCES:

- * T-45A NATOPS Flight Manual, A1-T45AB-NFM-000
- * Air Combat Maneuvering Flight Training Instruction (FTI)

LESSON PREPARATION:

Read:

- * T-45A ACM FTI “1 v 1 Engagement Concepts and Tactics” section

REINFORCEMENT: N/A

EXAMINATION:

The objectives in this lesson will be tested in ACMFP-05X.

(10-98) ORIGINAL

THIS PAGE INTENTIONALLY LEFT BLANK.

LESSON OBJECTIVES**6.7.3.5.1.1**

Recall the concepts and tactics applicable to basic fighter maneuvers (BFM)

6.7.3.5.1.2

Recall the parameters which constitute a neutral start

6.7.3.5.2

Recall the actions which lead to a one-circle fight

6.7.3.5.5

Recall the advantages/disadvantages of a one-circle fight

6.7.3.5.3

Recall the actions which lead to a two-circle fight

6.7.3.5.6

Recall the advantages/disadvantages of a two-circle fight

6.7.3.5.7

Recall out-of-plane (OOP) maneuvering tactical considerations

6.7.3.5.4

Recall the actions which lead to a vertical fight/merges

6.7.3.5.1

Assess the neutral 1 v 1 tactical situation

MOTIVATION

What would your game plan be in a one-on-one engagement? What planning will you do before climbing into the cockpit? You have learned specific maneuvers, but now you have to consider more of the fight. Will you use energy or angles to make your fight? Are you aware of your aircraft capabilities? Are you aware of your opponent's capabilities? What is your optimum AOA for extension or energy conservation? You must consider many variables as you prepare for your fight.

OVERVIEW

This lesson will enable you to employ appropriate tactics in a neutral engagement.

This lesson addresses:

- * High-aspect BFM
 - Flow
 - Out-of-plane (OOP) maneuvering
 - Vertical merges
- * Putting it all together

REFRESHER

The maneuvers you learned in offensive/defensive ACM lessons are applied during engagements resulting from neutral starts.

Sg 1, fr 1

*You may
also use the
T-45 Scale
Model*

ACM 1 v 1 NEUTRAL STARTS

- * **High-aspect BFM**
- * **Putting it all together**

Sg 1, fr 2

High Aspect BFM Considerations

- * Flow
- * OOP maneuvering
- * Vertical merges

PRESENTATION

I. **High-aspect BFM 6.7.3.5.1.1, 6.7.3.5.1.2**

A. **Considerations**

Sg 1, fr 3

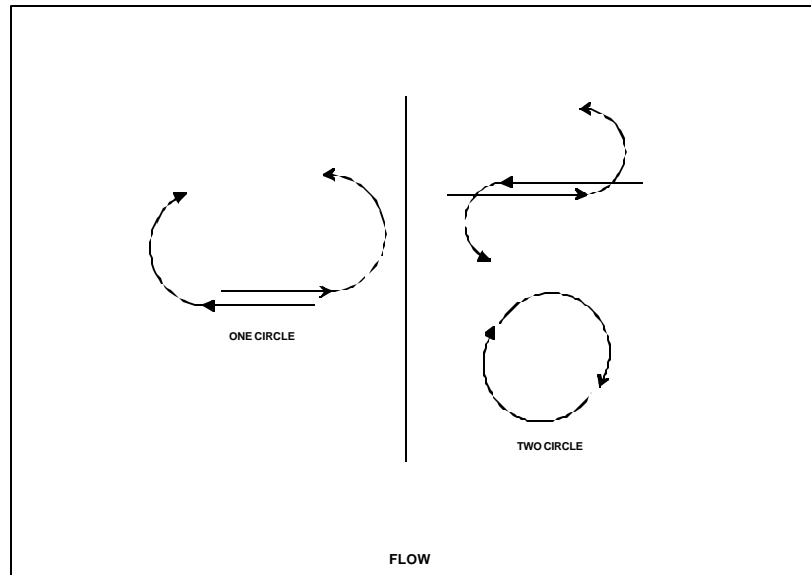

1. Flow

a. One-circle **6.7.3.5.2, 6.7.3.5.5**

- (1) One jet reverses at the merge, both jets fight for position advantage within the same turn circle
- (2) Advantage to jet with smallest relative turn radius
- (3) Uncountered out-of-plane maneuvering collapses relative turn radius
- (4) Goal for fighter is to maneuver around bandit post and reverse to capitalize on turning room available

b. Two-circle **6.7.3.5.3, 6.7.3.5.6**

- (1) Jets turn across each other's tail, maneuvering for nose-on within their own turn circle
- (2) Advantage to jet with best turn rate
- (3) Since forward quarter weapons are not trained to in the Training Command, two-circle option should capitalize on both rate and radius advantage for position

- (4) Uncountered OOP (nose low) will increase turn rate and collapse radius relative to opponent

Sg 1, fr 4

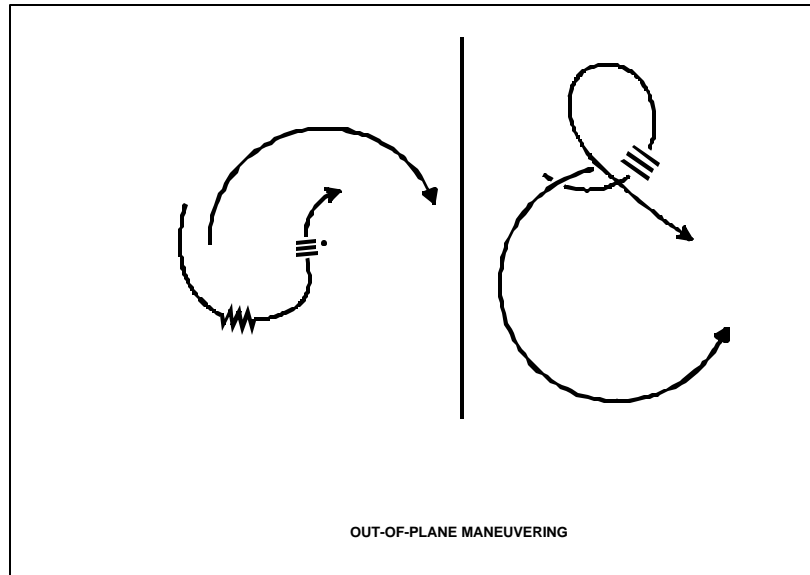

2. Out-of-plane (OOP) maneuvering 6.7.3.5.7

- Uncountered, provides advantage both in smaller radius (nose high or low) and better rate (nose low)
- Even slight delayed reaction from bandit will benefit fighter who employs OOP maneuvering intelligently (i.e., to maximize performance characteristic based on flow of fight)
- Fighter must counter bandit use of OOP instantly, either maneuvering to remain in plane or mirroring bandit move (ex., bandit pulls 30 degrees nose high one-circle, fighter counters 30-degree nose high)

Sg 1, fr 5

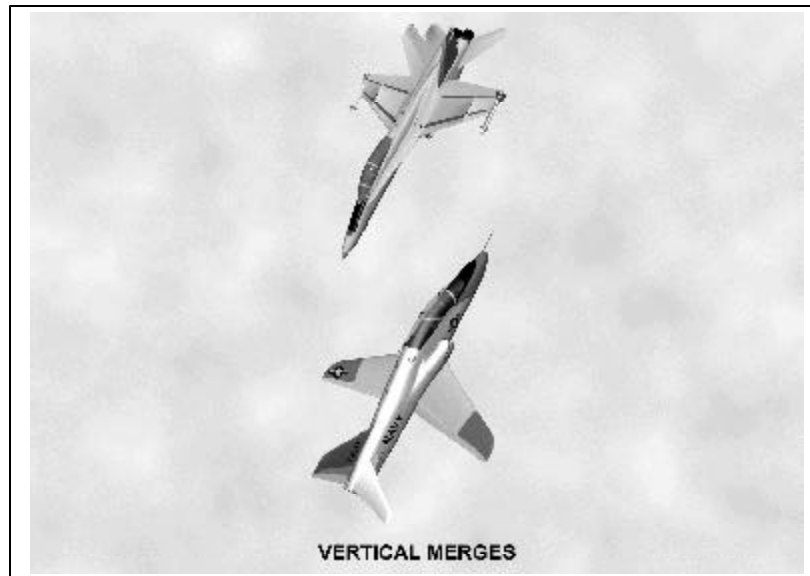

3. Vertical merges **6.7.3.5.4**

a. Low-to-high

- (1) Fighter may have option of aggressively early turning bandit, if bandit's nose is committed low
- (2) Influence nature of the vertical — in general, the steeper, the better

b. High-to-low

- (1) Try to shallow out the merge early, if possible
- (2) Use reversal, unload as required to gain extension if you believe the bandit is slow (little pitch authority) at the merge and unable to keep fighter in same turn circle by bringing nose to bear rapidly
- (3) If bandit aggressively turns fighter, putting lift vector on and entering two-circle spiral is an option

Sg 2, fr 1

ACM 1 v 1 NEUTRAL STARTS

- * High-aspect BFM
- * **Putting it all together**

Sg 2, fr 2

DEVELOP GAME PLAN

- * One-circle nose high
- * One-circle nose low
- * Two-circle nose low
- * Vertical
- * Extension

II. Execution (Putting it all together) 6.7.3.5.1

A. Develop a game plan prior to the merge

1. Attempt to drive bandit into reactionary mode
2. Assume the bandit knows BFM and be prepared to fly out of your game plan if required

LESSON NOTES

Whenever a topic is supported by both a screen projection and animated video, you will have a menu. You cannot stop the animation once it has begun to play. Choosing "Animation" will display the first frame of the animation. Select "MORE" to start the animation or "NAVIGATE" to return to the menu. Choosing "Diagram" will call up the screen projection, which will be a ribbon diagram or spaghetti diagram of the maneuver. Use your own discretion as to which you show first, and continue the lesson by choosing "Continue" at the end of the menu.

Sg 2, fr 3

HEAD-ON PASS
ANIMATION

Sg 2, fr 4

- FIGHTS
1. Two-circle animation
 2. Two-circle diagram
 3. One-circle animation
 4. One-circle diagram
 5. Continue with lesson
- Please select

*Animation (1)
Sg 2, fr 5*

TWO-CIRCLE
ANIMATION

*Diagram (2)
Sg 2, fr 7*

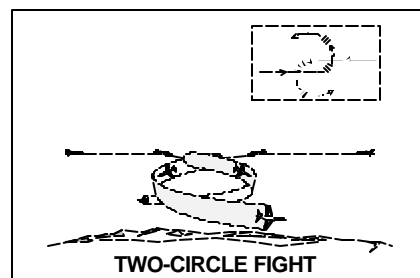

*Animation (3)
Sg 2, fr 8*

ONE-CIRCLE
ANIMATION

*Diagram (4)
Sg 2, fr 10*

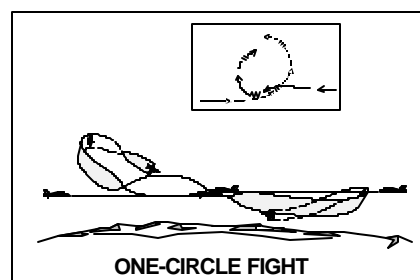

Sg 2, fr 11

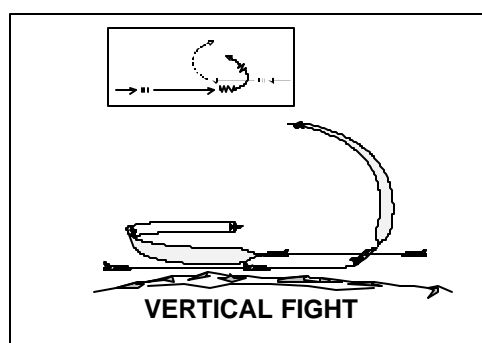

3. If bandit allows significant turning room at the merge, take it!

Sg 2, fr 12

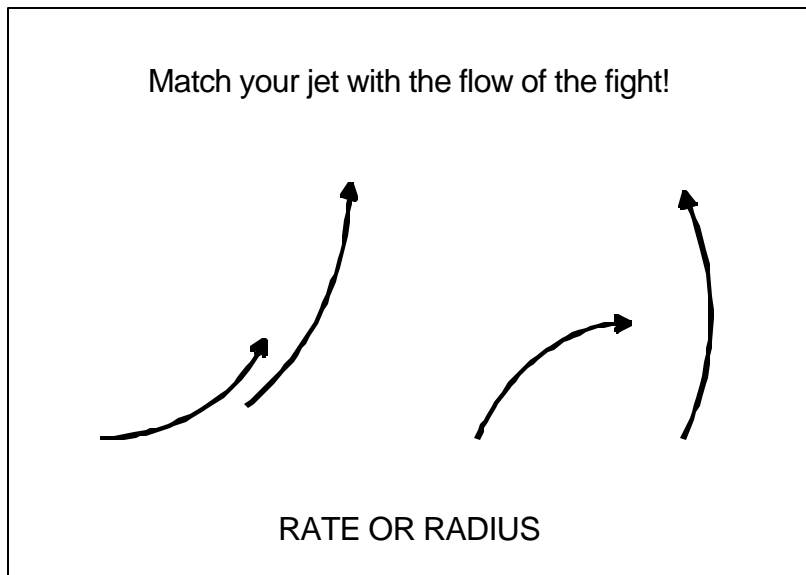

B. Fly your jet to maximize position advantage/minimize time to kill

1. If two-circle, maximize *sustained* turn rate
2. If one-circle, collapse turn circle to create turning room and take it!
3. Manage your energy wisely
 - (a) If selling significant energy will get you a kill shot, take it!
 - (b) If the fight appears protracted, higher energy will win in the long haul (unless some bonehead BFM comes into play)

Sg 2, fr 13

PRIORITIES

- * Survive
- * Kill
- * Control

4. Keep in mind priorities

- (a) When neutral, strive to become offensive and kill
- (b) If you start to lose position advantage, think about bugging
- (c) Anytime a quick kill can't be achieved, disengagement is a smart option. (There's no shame in disengaging from an offensive position if you just can't bring weapons to bear. OK, maybe there's a little shame but consider what it's like when you leave the comfy confines of the TRACOM.) Bandit's rarely travel alone!

Sg 3, fr 1

ACM 1 v 1 NEUTRAL STARTS

REVIEW OPTIONS

1. Entire lesson
2. High-aspect BFM
3. Putting it all together
4. End this lesson

Please select

SUMMARY

During this lesson we discussed:

- * High-aspect BFM
 - Flow
 - Out-of-plane maneuvering
 - Vertical merges
- * Putting it all together

CONCLUSION

Building on your knowledge of offensive/defensive maneuvers, we have introduced and discussed how ACM fights may develop from a neutral start. In order to be effective from the start, use the tactics taught in this lesson to your advantage in the air. Start your game planning now! Check SIX!

NOTES

FLIGHT SUPPORT LECTURE GUIDE

COURSE/STAGE: T-45A UJPT, ADV, & IUT Air Combat Maneuvering

LESSON TITLE: Air Combat Maneuvering 2 V 1 Flight Procedures

LESSON IDENTIFIER: T-45A UJPT, ADV, & IUT ACMFP-06

LEARNING ENVIRONMENT: Classroom

ALLOTTED LESSON TIME: 2.7

STUDY RESOURCES:

- * T-45A NATOPS Flight Manual, A1-T45AB-NFM-000
- * Air Combat Maneuvering Flight Training Instruction

LESSON PREPARATION:

Read:

- * T-45A ACM FTI "2 v 1 Mission Procedures/Maneuvers" section

REINFORCEMENT: N/A

EXAMINATION:

The objectives in this lesson will be tested in ACMFP-07X.

(10-98) ORIGINAL

THIS PAGE INTENTIONALLY LEFT BLANK.

LESSON OBJECTIVES**6.1.1.1**

Recall procedures/guidelines provided by ACM briefing

6.7.1.1

Recall rules of engagement (ROE) for conducting ACM training

6.7.2.2.1

Recall parameters of the weapons envelope used by CNATRA

6.7.2.2.2

Recall ACM working areas and enroute/RTB procedures

6.7.2.1.1

Recall weather minimums/requirements for ACM

6.7.3.1

Recall ACM tactical communications plan/usage

6.7.2.6.1

Identify energy components for the T-45A

6.7.3.1.5

Recall tactical considerations and ACM brief board information

6.7.4.10.3

Recall procedures for conducting G-LOC turns

6.7.4.10.2

Recall engaged/free fighter tactical doctrine applicable to ACM

6.7.4.1.3

Recall 2 v 1 mutual support tactical and procedural considerations

6.7.4.10.1.1

Recall the 2 v 1 considerations for disengagement

6.7.4.8.1

Recall procedures for 2 v 1 disengagement

5.7.1.3.1.3

Describe the correct position and purpose of the combat spread formation

6.7.1.3.1

Recall other tactical formations used in ACM

6.7.4.1.2

Recall tactical communications requirements for ACM

6.7.4.1.4

Recall additional tactical considerations for ACM

6.7.4.10

Assess 2 v 1 tactical situation (used for all engagements)

6.7.4.10.1

Recall the concepts and tactics applicable to 2 v 1 ACM

6.7.4.1.1

Recall responsibilities of each aircraft in the “call the bandit” exercise

6.7.4.9.1

Describe actions of engaged/free fighter response to counterflow rear quarter attack

6.7.4.2.1

Describe actions of engaged/free fighter response to no-switch rear quarter attack

6.7.4.3.1

Describe actions of engaged/free fighter to single-switch exercise

6.7.4.4.1

Describe action of engaged/free fighter in response to multi-switch exercise

6.7.4.7.1

Describe actions of engaged/free fighter in VFQ attack

6.7.4.7.2

Describe actions of engaged/free fighter in response to abeam attack

6.7.1.3.1

Recall methods for regaining section integrity

6.7.4.11.1

Recall the procedures for beyond visual range (BVR) engagements

OUTLINE

Part 1

- * Training Rules
- * Fighter Engagement Videos
- * Self-Test
- * Conduct of Hop
- * Engaged/Free Fighter Doctrine
- * Formations
- * Communication
- * Additional Considerations

Part 2

- * Engagements
- * Review

MOTIVATION

The relatively simple fighters of previous wars that relied solely upon the gun to kill have given way to the more sophisticated fighters of today that can employ missiles out to several miles. Through an evolutionary process, the tactical communities have developed a two-aircraft formation and a set of tactical principles that will optimize the section's combat potential in the visual combat arena.

As you begin your final ACM lesson, you must learn those tactics that support a section member in ACM engagements. In order to effectively defeat a bandit, you must maintain section integrity and mutual support. All of the skills you have learned thus far in your training will be put to critical scrutiny in the ACM environment.

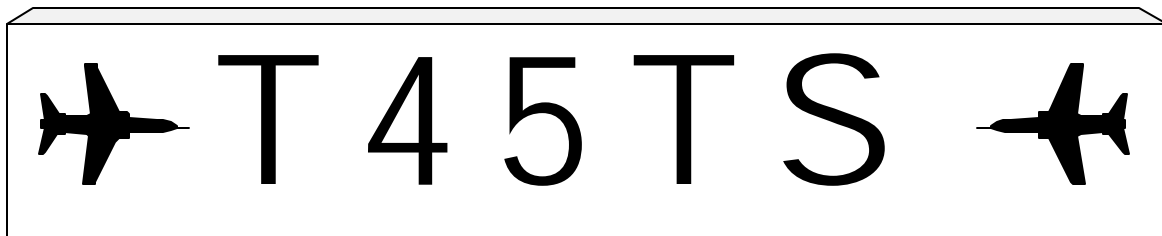
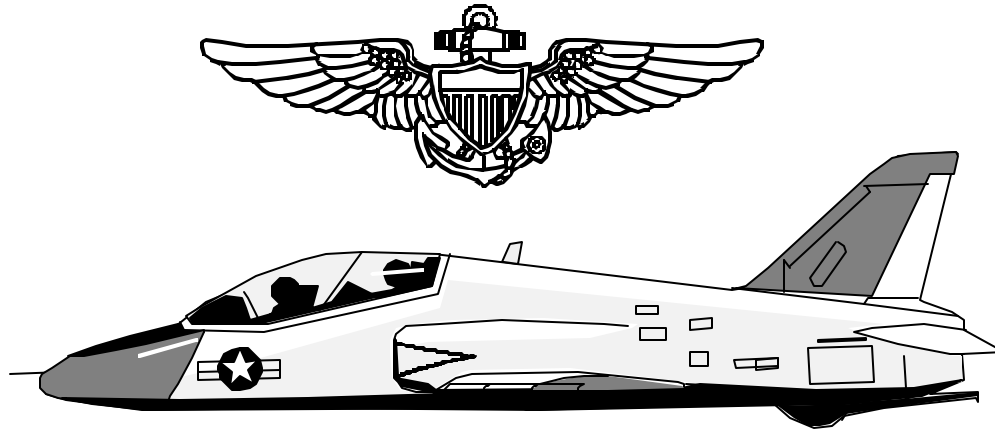

T-45A UJPT, ADV, & IUT ACMFP-06

AIR COMBAT MANEUVERING 2 V 1 FLIGHT PROCEDURES

Part 1

TRAINING RULES FOR THREE-PLANE ACM LECTURE

Question and Answer Policy

Snacks and Drinks Okay

Breaks As Needed

Class Participation Required

OVERVIEW

Part 1

- 1. Fighter Engagement Videos**
- 2. Self-Test**
- 3. Conduct of Hop**
- 4. Engaged/Free Fighter Doctrine**
- 5. Formations**
- 6. Communication**
- 7. Additional Considerations**

Part 2

- 1. Engagements**
- 2. Review**

MOTIVATIONAL VIDEO

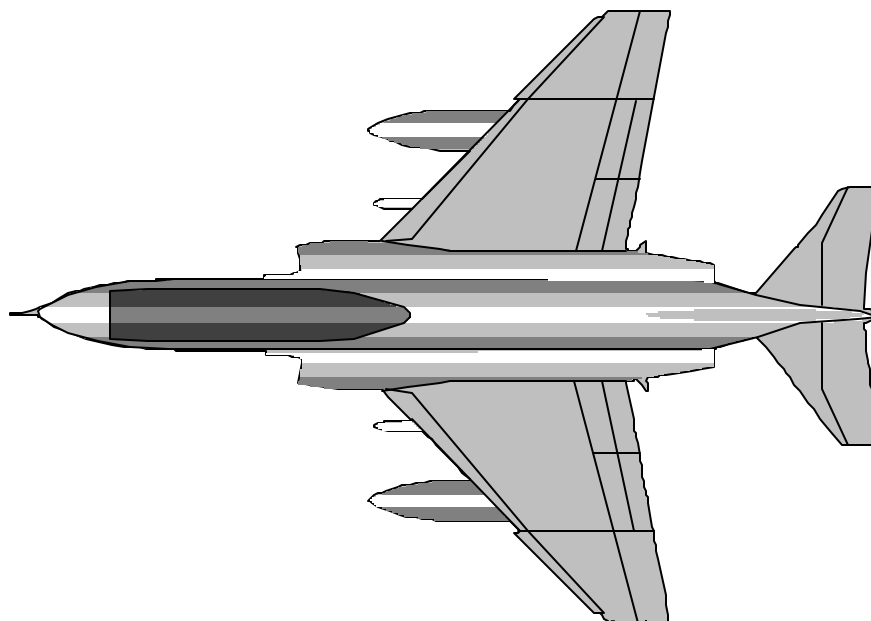

SELF-TEST



Let's see if we are ready to jump
into three-plane ACM.

NOTE: The self-test is in the back of the ACM FTI.

CONDUCT OF HOP

Brief

Departure and En Route

Engagement Flow

RTB

CONDUCT OF HOP Brief

ACM TRAINING RULES

Required for all participants

CONDUCT OF HOP Brief

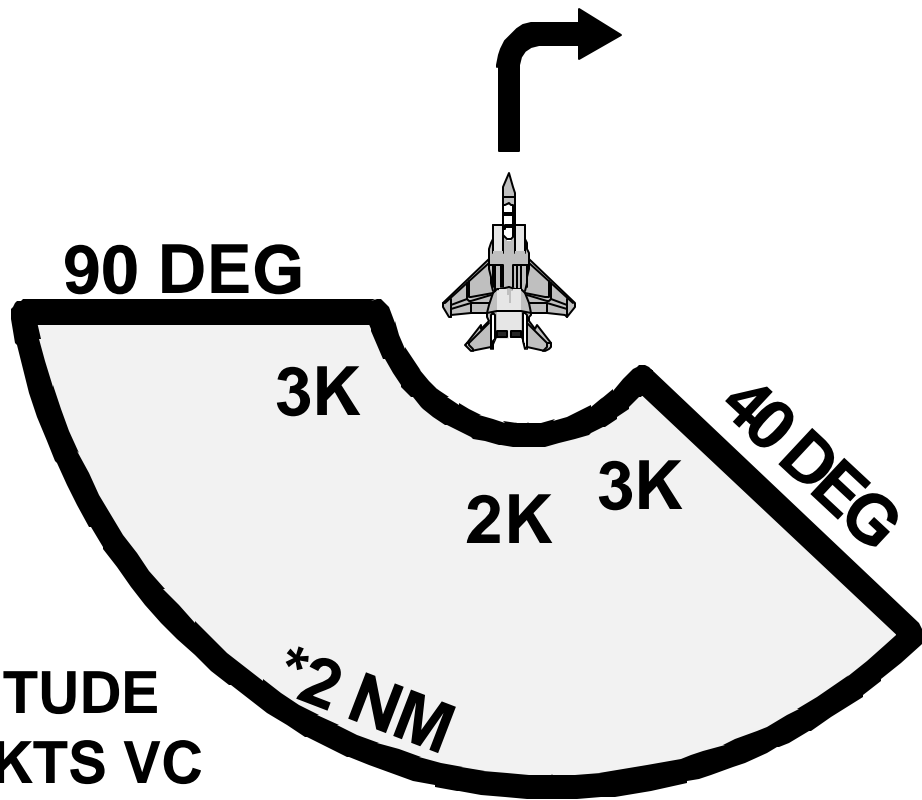

*** LOW ALTITUDE
AND > 100 KTS VC
= 1.5 NM**

Weapons Envelope

CONDUCT OF HOP Brief

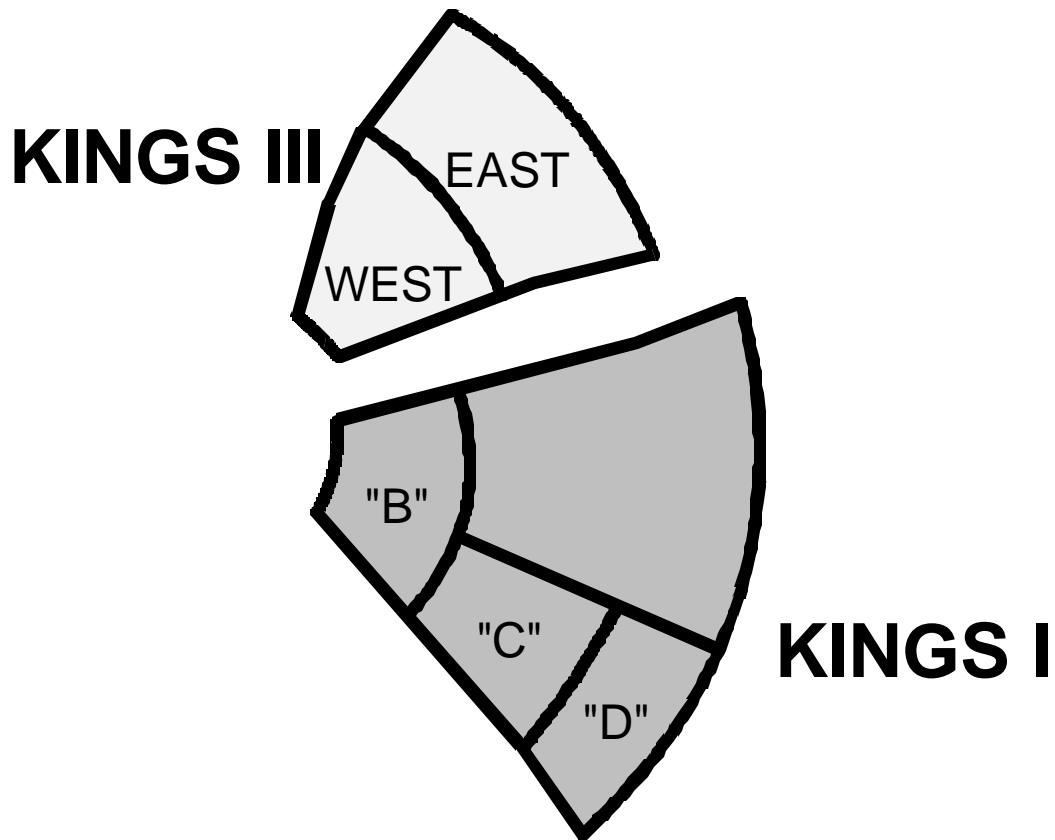

ACM Working Areas

CONDUCT OF HOP Brief

W-228D

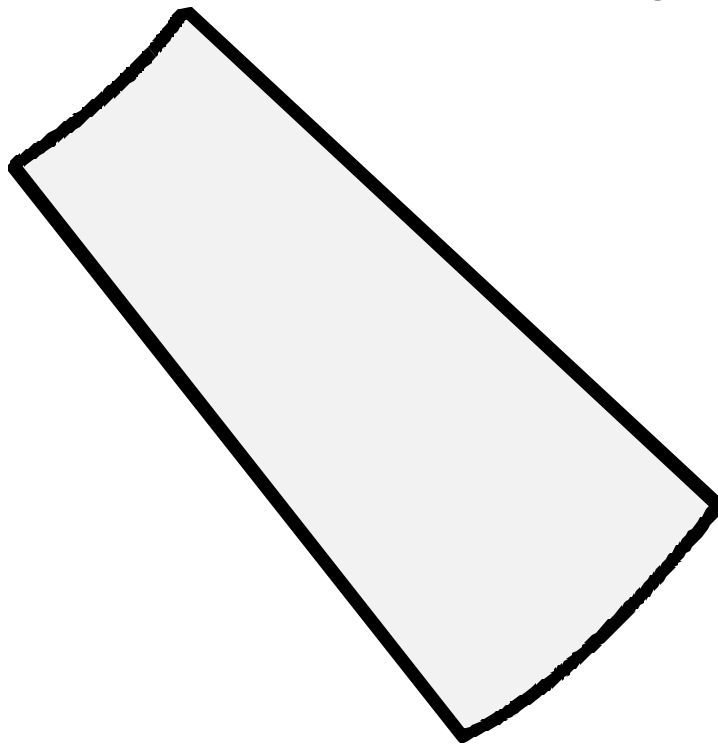

ACM Working Areas

CONDUCT OF HOP Brief

Weather mins:

1. Remain 1 nm horizontal and 2,000 ft from all clouds
2. Must have 5 nm visibility with a defined horizon
3. Must have 15,000 ft min between cloud layers
4. Hard deck will be at least 5,000 ft above cloud tops

Dual: OPNAV mins (max cloud tops 8,000 ft)

Solo: 1,000 ft/3 sm (max cloud tops 7,000 ft)

* CO can waive down to 500/2 for solos

CONDUCT OF HOP Brief

Comm plan:

1. Start up with tactical freq in comm 2
 - Use it for admin enroute comm
 - Switch back to button 1 when clear of duty
 2. Use area freq for all fighter comm
- ** Do not use button 5 for tactical comm

CONDUCT OF HOP Brief

Comm plan:

| COMM1 | COMM2 |
|------------|-------------|
| 20 | 18/30/252.5 |
| 19 | |
| 1 | |
| 2 | |
| 3 | |
| 4 | |
| 5 | |
| 6/7/8/9/10 | |
| 20 | |
| 11 | |
| 3/17 | |
| 2/16 | |
| 1 | |

CONDUCT OF HOP Brief

Fuel:

1. “Joker Fuel”

A fuel state set far enough above bingo fuel to allow a successful disengagement.

2. “Bingo Fuel”

A fuel state at which the fighter must return to ship or home base.

CONDUCT OF HOP Brief

Fuel:

1. Fuel is one of the most critical items that a fighter must monitor
2. Typical local area joker and bingo states = 1.2/1.0 to 1.0/800

CONDUCT OF HOP Brief

Determining factors:

1. Distance to base
2. Weather
3. Mission (dual/solo)
4. Field status (FCLPs, PAR, single rwy?)
5. Threat (types and #'s of bandits and SAMS)

CONDUCT OF HOP Brief

Emergencies:

1. Takeoff aborts
2. NORDO/ICS failure
3. Loss of NAVAIDS
4. Lost plane
5. Lost sight/LCLS
6. System failure
7. Midair
8. Ejection
9. Down plane/SAR

CONDUCT OF HOP Brief

Brief board:

| | | | |
|---------------|-----------|------|------|
| MISSION | | | |
| A/C | CALLSIGNS | SOE | EP'S |
| _____ | _____ | | |
| _____ | _____ | | |
| _____ | _____ | | |
| WX | | | |
| AREA | | COMM | QOD |
| JOKER/BINGO | | | |
| WEPS ENVELOPE | | | |

CONDUCT OF HOP

Departure and En Route

Takeoff Options

Lead Change

G-WARM Turns

CONDUCT OF HOP

Departure and En Route

Takeoff options:

1. Section go for lead and “2” with “3” executing a 10-second running rendezvous
2. 10-second running rendezvous for dash “2” and “3” (crosswind limits)
3. Individual takeoffs with TACAN rendezvous for all (bad weather--need separate clearance)

CONDUCT OF HOP

Departure and En Route

Lead change:

1. Bandit will pass lead to “2” once confirmed that fighters have each other in sight
 - Fighter lead assumes flight lead and is responsible for area management. Bandit will now answer as “3”
 - Fighter lead ensures bandit is outside formation before pushing wingman into combat spread

CONDUCT OF HOP

Departure and En Route

G-WARM:

1. OPNAV 3710.7 requires 180 degrees of turn to the maximum amount of g's anticipated on that particular flight
 2. TW-2 executes this G-WARM as two 90-degree turns at approximately 4 g's
- * Kid, G-WARM left. . . "2" . . . "3" . . .
Kid, G-WARM right. . . "2" . . . "3"

CONDUCT OF HOP Engagement Flow

ACM - 10 (Dual)

| | |
|-------------------|-------------------------|
| Call the bandit | Do X 2 |
| Counterflow | Demo/Do X 2 |
| No switch | Do X 2 |
| Single switch | Demo/Do X 2 |
| Multi-switch bug | Demo X 1 |
| Multi-switch kill | Do X 1 |
| Multi-switch bug | Do X 1 (Gas permitting) |

CONDUCT OF HOP

Engagement Flow

ACM - 11X (Dual)

| | |
|--------------------------|-----------------------------|
| Call the bandit | Do X 2 |
| Counterflow | Do X 2 |
| Single switch | Do X 2 |
| Multi-switch bug or kill | Do X 2 |
| VFQ | Demo/Do X 2 |
| BVR | Demo/Do (Gas permitting) |

CONDUCT OF HOP Engagement Flow

ACM - 12 (Solo)

| | |
|--------------------------|--------|
| Call the bandit | Do X 2 |
| Counterflow | Do X 2 |
| Multi-switch bug or kill | Do X 2 |
| VFQ | Do X 2 |
| BVR | Do X ? |

CONDUCT OF HOP Engagement Flow

ACM - 13 (Solo)

| | |
|--------------------------|--------|
| Call the bandit | Do X 2 |
| Counterflow | Do X 1 |
| Multi-switch bug or kill | Do X 1 |
| VFQ | Do X 1 |
| BVR | Do X ? |

* NOTE: Conduct is at IP's discretion
(may do more BVRs)

CONDUCT OF HOP RTB

The fighter lead will lead back:

1. Dash 2 picks one side (bandit gets the other)
2. Bandit is Dash-3

Recoveries:

1. Stage II/4-second break
2. Individual TOPS IFR/TOPS GCA

ENGAGED/FREE FIGHTER DOCTRINE

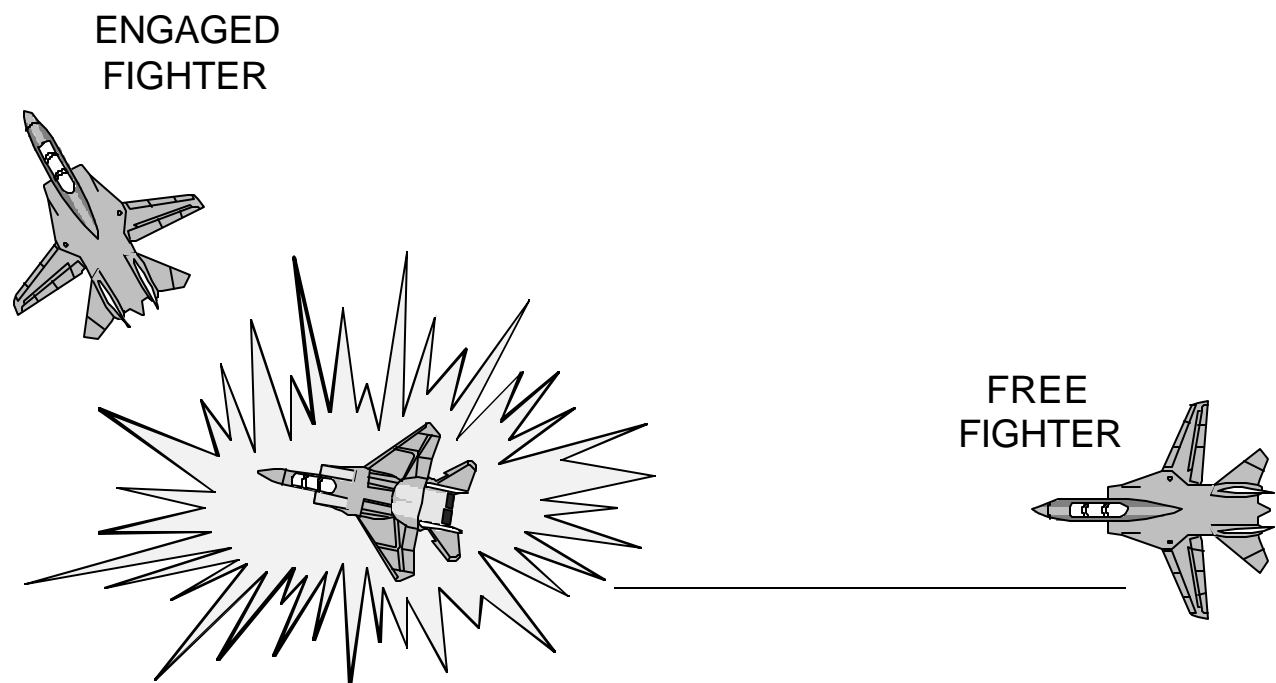

SIMPLE DEFINITION: Engaged fighter keeps bandit tied up while the free fighter maneuvers into position to ambush the bandit.

ENGAGED\FREE FIGHTER DOCTRINE

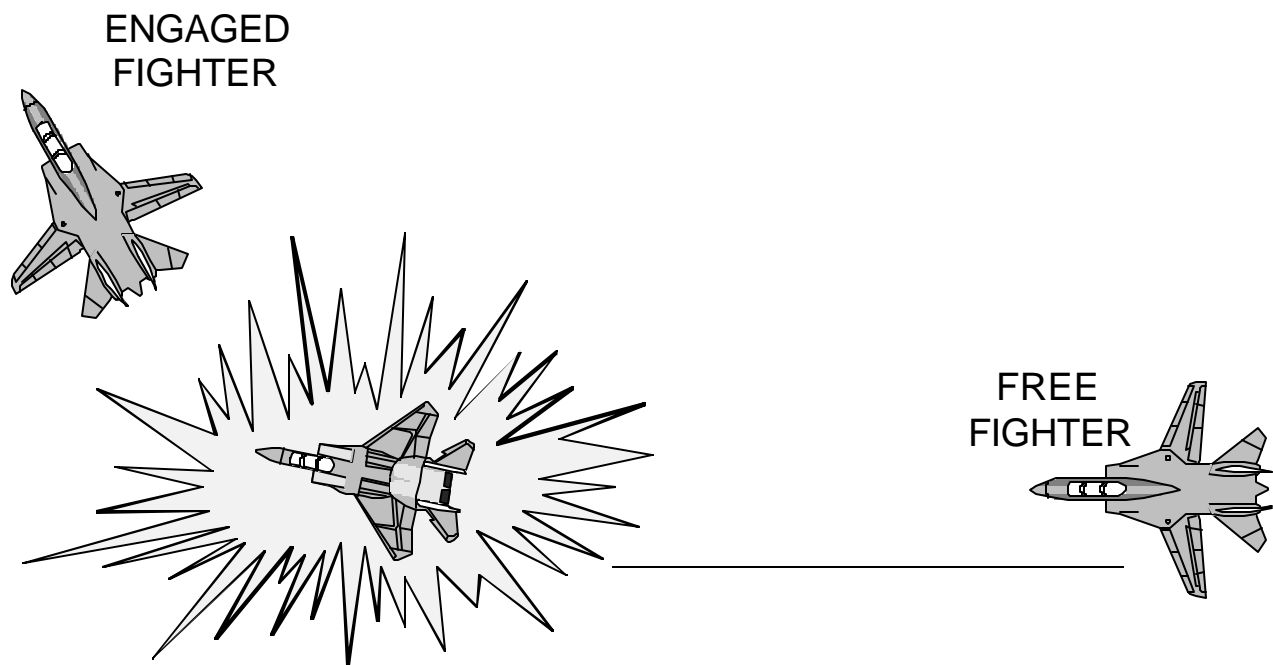

ENGAGED FIGHTER: That member of the section with the best capability of forcing the bandit into a predictable flight path (offensive or defensive).

ENGAGED\FREE FIGHTER DOCTRINE

ENGAGED
FIGHTER

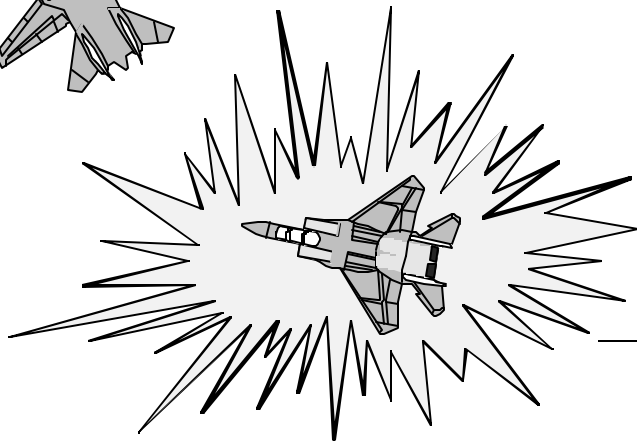
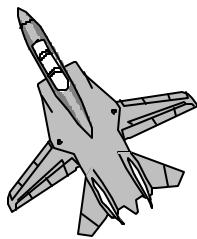

FREE
FIGHTER

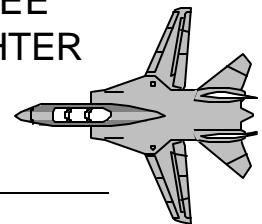

FREE FIGHTER: That member of the section not pressing the bandit into a predictable flight path while he maneuvers for an offensive position to employ weapons.

ENGAGED\FREE FIGHTER DOCTRINE

Engaged Fighter Objectives:

(Defensive or offensive)

1. Kill the bandit
2. Keep the bandit in sight
3. Bleed the bandit's energy
4. Force the bandit to be predictable
5. Deny the bandit a shot opportunity
6. Force the bandit to fight your fight
7. Maintain high-energy level
8. Clear own "six"

ENGAGED\FREE FIGHTER DOCTRINE

Free Fighter Objectives:

1. Kill the bandit
2. Keep track of engaged fighter and bandit
3. Clear engaged fighter's and own "six"
4. Maintain high-energy state
5. Get out-of-plane and out-of-phase
6. Attempt to maneuver to bandit's blind spot
7. Direct the fight if required

ENGAGED/FREE FIGHTER DOCTRINE

Advantages:

1. Tactical capability of two aircraft more than doubles when a section works effectively together
2. Mutual support assists the section in engaging the bandit, achieving a quick kill, and regaining section integrity

NOTE: This assumes a high level of skill for both fighters.

ENGAGED/FREE FIGHTER DOCTRINE

Bottom Line

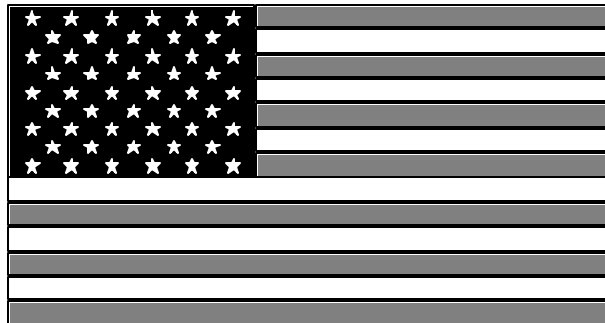

Team Work!!

FORMATIONS

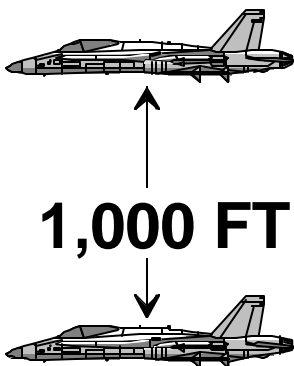

Combat Spread

FORMATIONS

Advantages of Combat Spread:

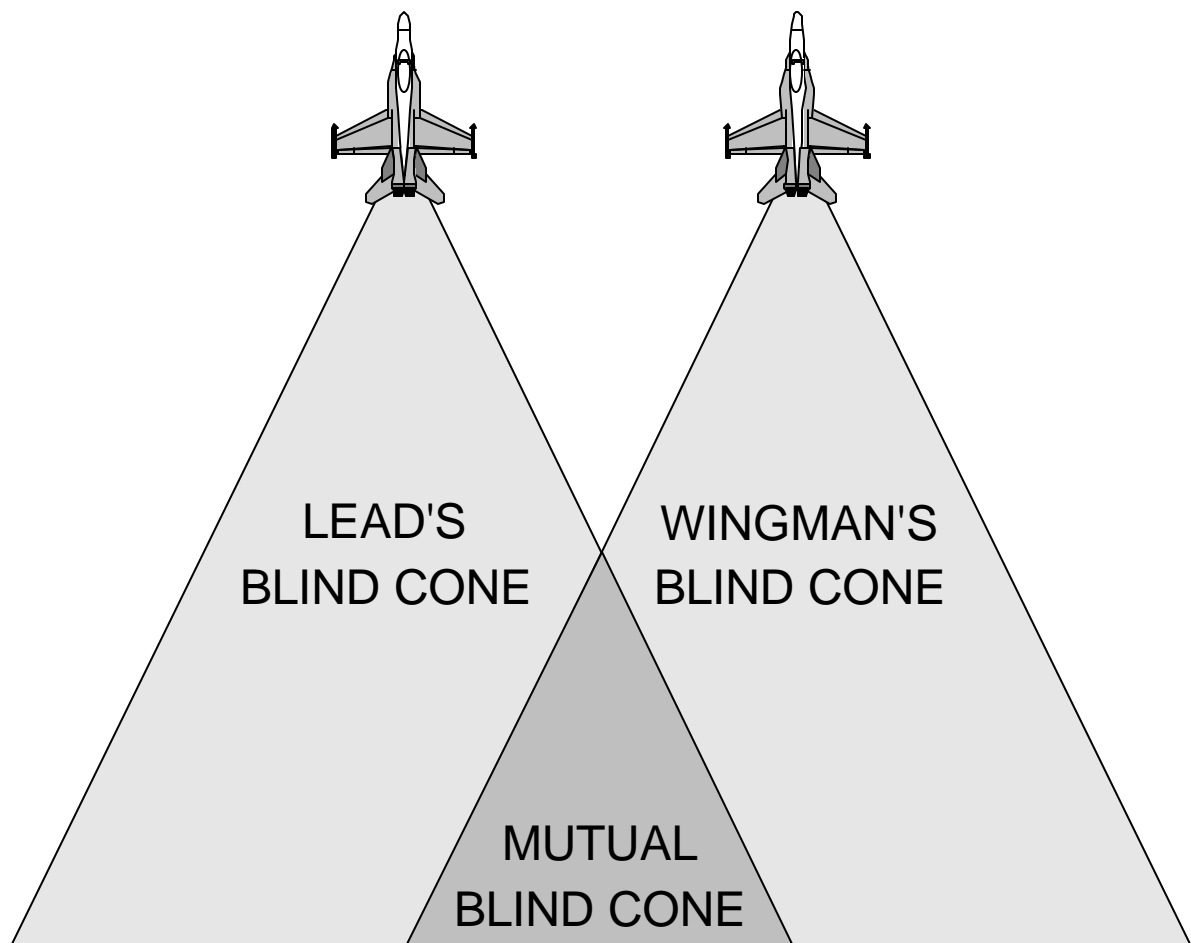

1. Visual limits are increased

FORMATIONS

Advantages of Combat Spread:

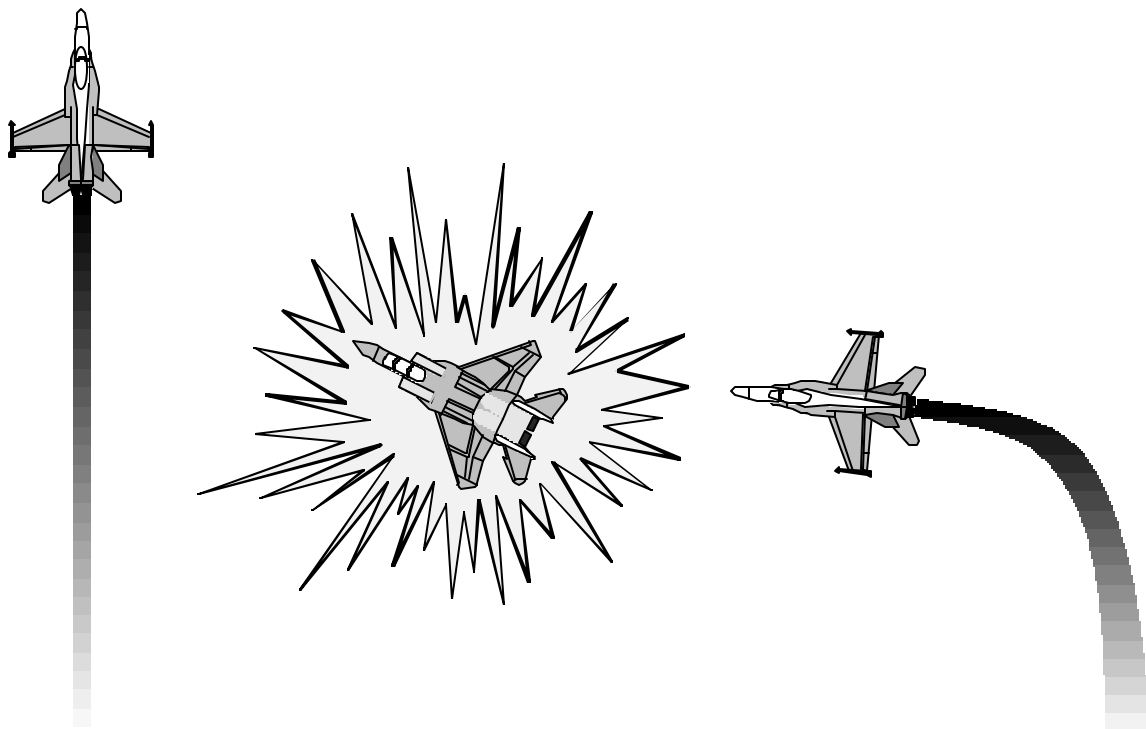

2. Detection more difficult for bandit

FORMATIONS

Advantages of Combat Spread:

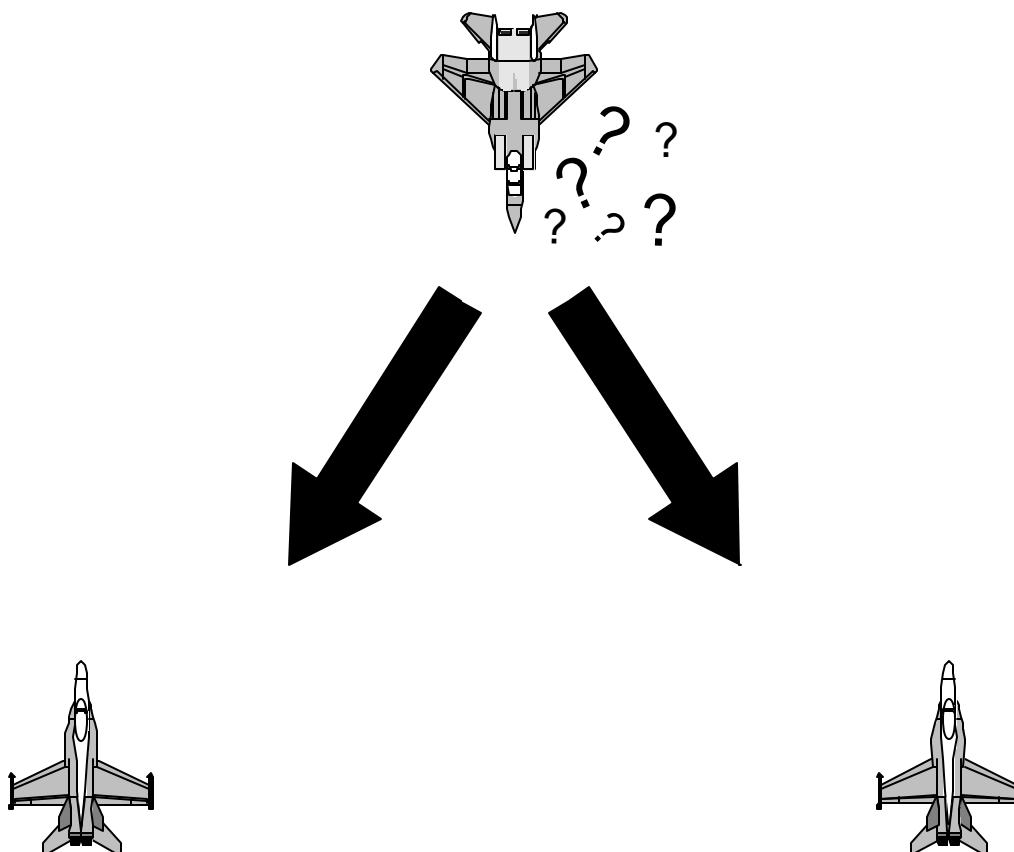

3. Forces early commitment on one fighter or the other by the bandit

FORMATIONS

Advantages of Combat Spread:

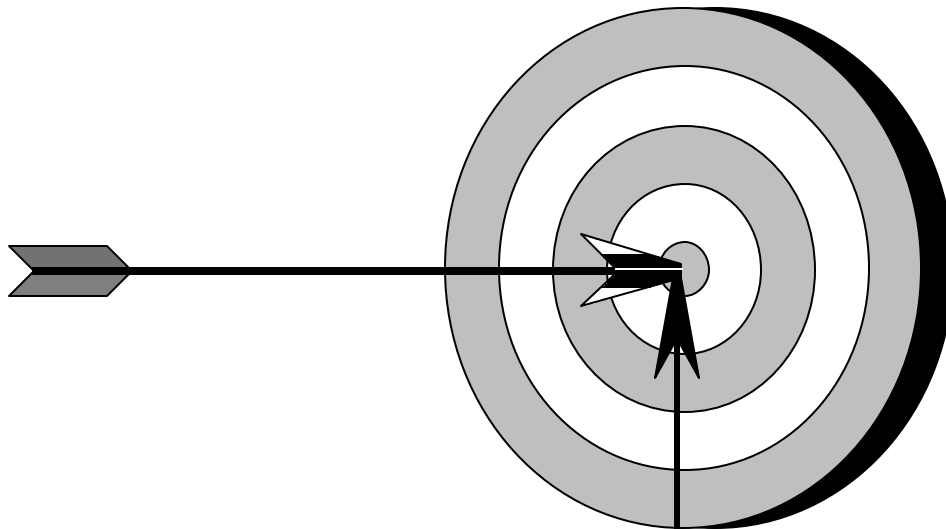

4. Weapons employment more effective

FORMATIONS

Advantages of Combat Spread:

5. Maneuverability increases:
 - a. More time for lookout versus flying form
 - b. Fighters may use maximum performance turns with little risk of midair collision or losing sight of each other

FORMATIONS

Advantages of Combat Spread:

6. Flexible:
 - a. When wingman has initial visual contact with the bandit, he directs the flight and assumes the tactical lead role.
 - b. Rapid role designation enables section to quickly employ full combat potential

FORMATIONS

Other Types of Section Formations

FORMATIONS

Lead-Trail:

1. Very offensive
2. Low mutual support
3. Wingman vulnerable
4. Difficult to stay together

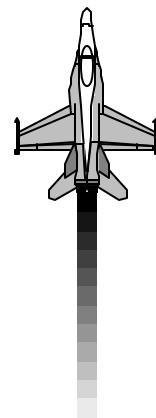
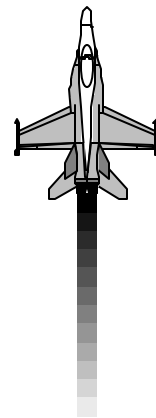

FORMATIONS

Fighter Wing:

1. Easy to stay together
2. Wingman has low situational awareness
3. Poor mutual support
4. Easy for bandit to see both fighters

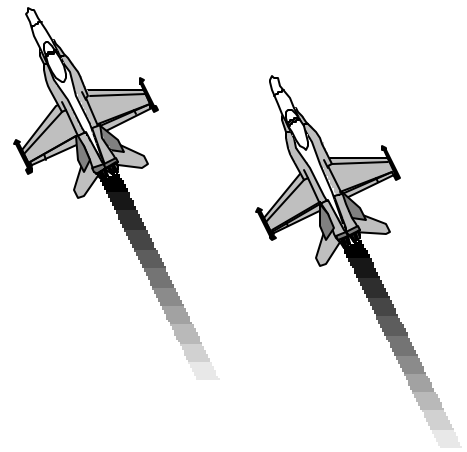

FORMATIONS

High-Low:

1. Offensive
2. Low mutual support
3. Wingman and lead vulnerable
4. Very difficult to stay together



FORMATIONS

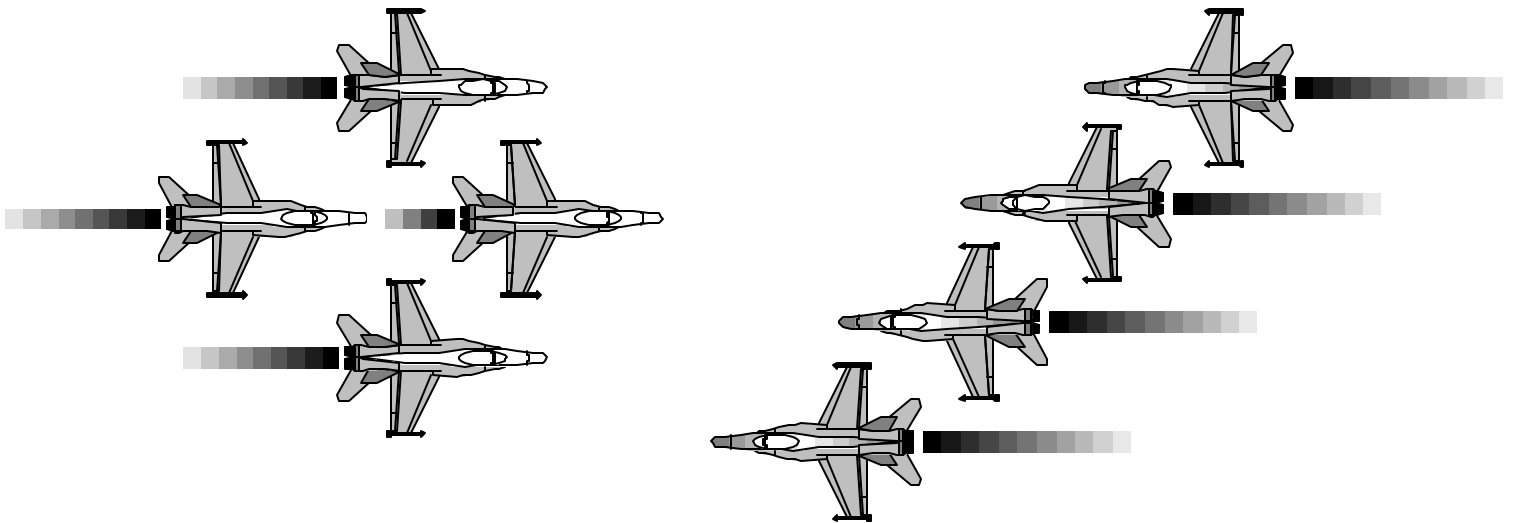

“Never break your formation into less than two-ship elements. Stay in pairs. A man by himself is a liability; a two-ship team is an asset. If you are separated, join up immediately with other friendly airplanes.”

Major Thomas B. “Tommy” McGuire, USAAF

COMMUNICATION



The most challenging aspect of three-plane ACM is good comm.

COMMUNICATION

Communication must be:

1. Clear
2. Concise
3. Accurate

COMMUNICATION

Talk and Turn:

1. When the bandit is detected close in (less than 3 nm), the section member with a “tally” must employ tactical maneuvering **while** communicating with his wingman--not after!
2. His wingman must execute the called maneuvering **while** responding--not after!

COMMUNICATION

Standard Call:

1. Call sign "Blaze"
2. Maneuver "Hard right"
3. Detection "MIG"
4. Direction "Right 3"
5. Elevation "Slightly low"
6. Range "1 mile"
7. Remarks "Nose on"

COMMUNICATION

Standard Responses:

1. “No joy”
 2. “Tally, engaged”
 3. “Tally, free”
- * Update visual status as soon as bandit is sighted

COMMUNICATION

Comm Priority

Most important comm is to define
free and **engaged** roles **ASAP**.

COMMUNICATION

Cadence:

1. Practice good cadence by transmitting, then pause for reply If no reply after a few seconds, transmit, then pause again
2. Do not step on each other Listen to what your lead/wingman is saying; think, then talk

COMMUNICATION

Using verbal shorthand assists in clear, concise transmissions.

Provide a simple statement of intentions early to allow your section to work as a team.

ADDITIONAL CONSIDERATIONS

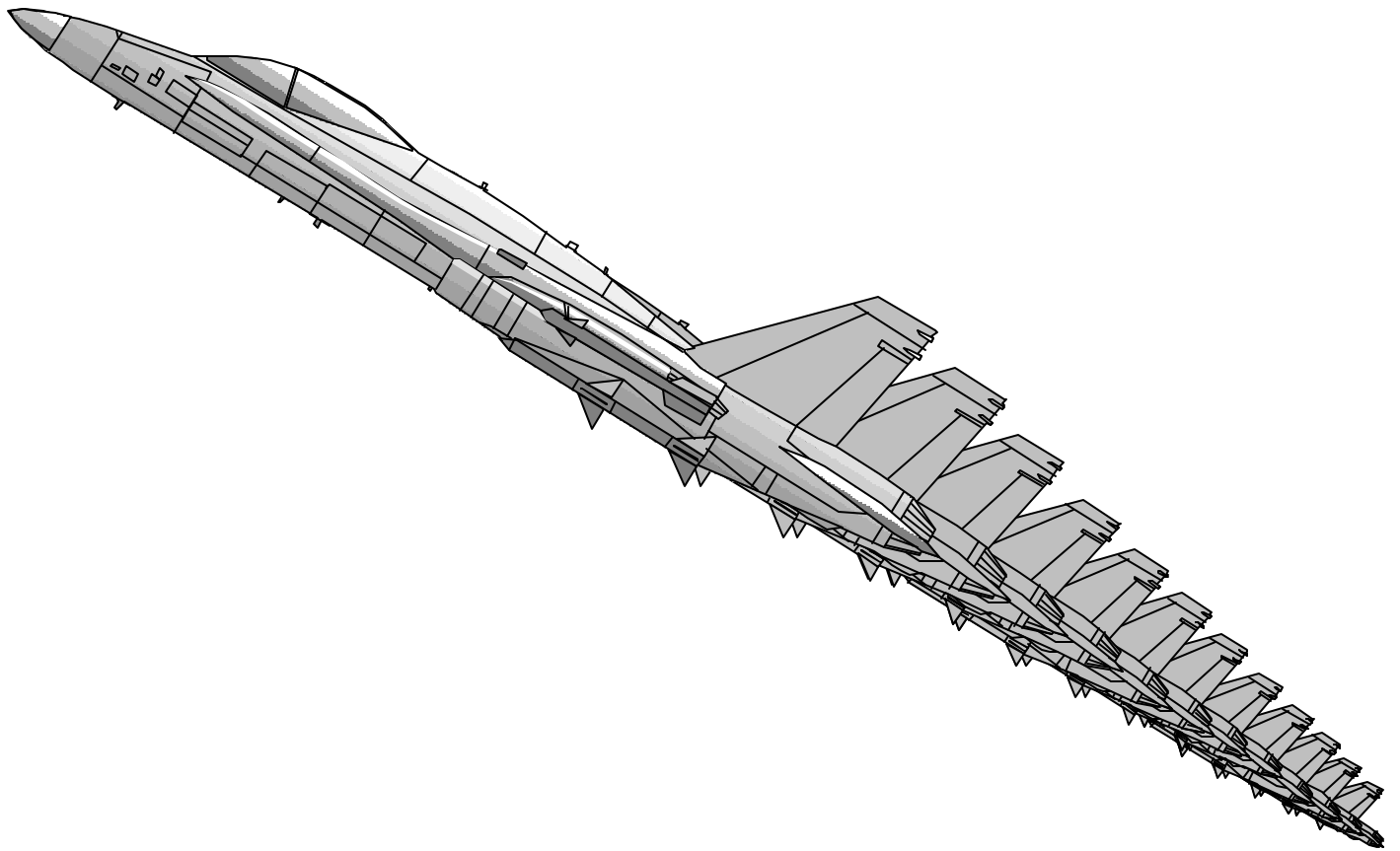

ADDITIONAL CONSIDERATIONS

Weather:

1. Undercast/Overcast. . .
 . . .improves visual range
2. Bad weather. . .
 . . .increases joker/bingo
3. IFR weather. . .
 . . .is bandit VFR only
4. Hide in a cloud. . .
 . . .IR/radar will find you

ADDITIONAL CONSIDERATIONS

The Bandit:

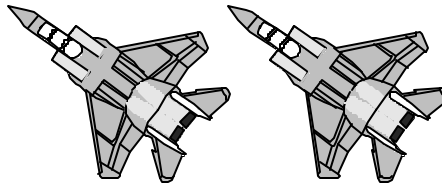

1. Type of bandit aircraft?
2. Weapons load?
3. Fuel load?
4. GCI required for bandit?
5. What tactics does bandit use?

ADDITIONAL CONSIDERATIONS

Maneuvering Out of Plane:

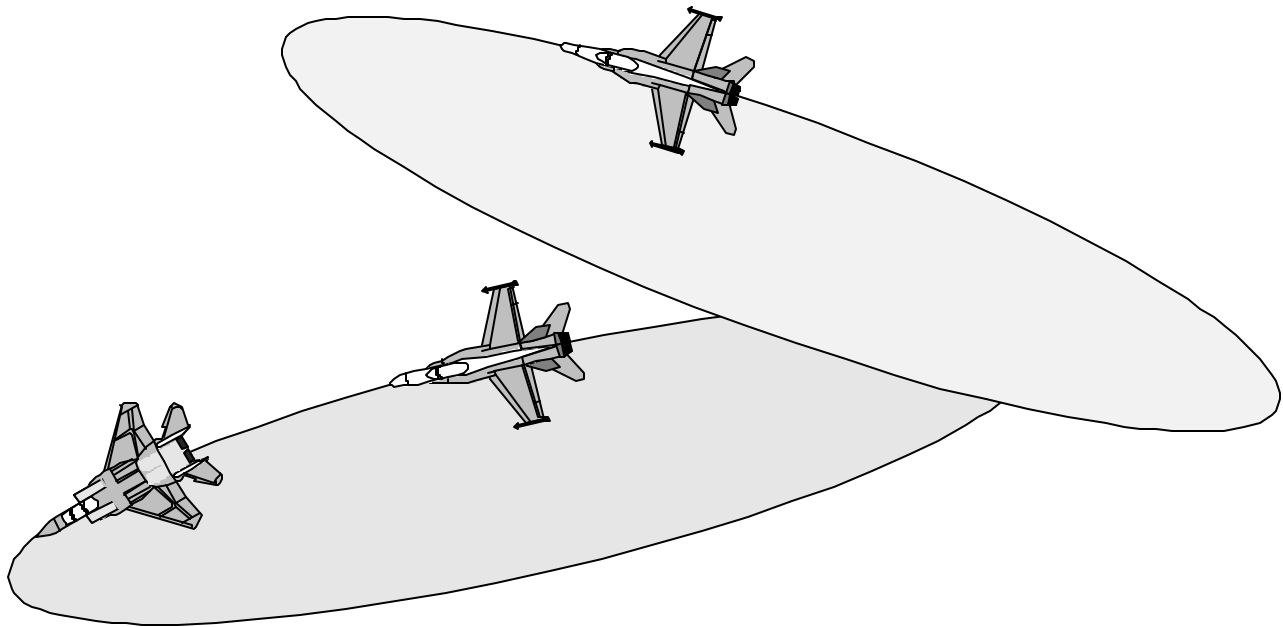

1. Forces early commit
2. Difficult for bandit to shoot free fighter
3. Difficult for bandit to keep sight

ADDITIONAL CONSIDERATIONS

Maneuvering Out of Phase:

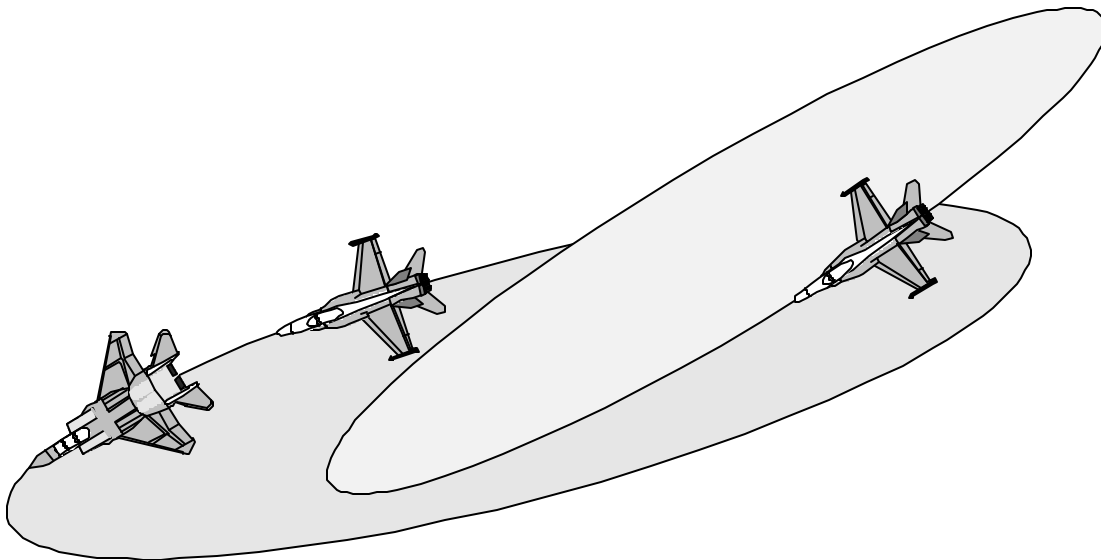

1. More flexibility to maneuver for shot
2. Free fighter able to keep high energy state
3. Difficult for bandit to keep sight of or shoot at the free fighter

ADDITIONAL CONSIDERATIONS

Maneuvering Don'ts:

1. Staying in the same dimensional plane
2. Meeting wingman close aboard
3. Losing sight (especially on bugout)

ADDITIONAL CONSIDERATIONS

Maneuvering Do's:

1. Force bandit to commit early
2. Avoid splitting into singles
3. Go for quick kill
4. Attempt to bracket bandit

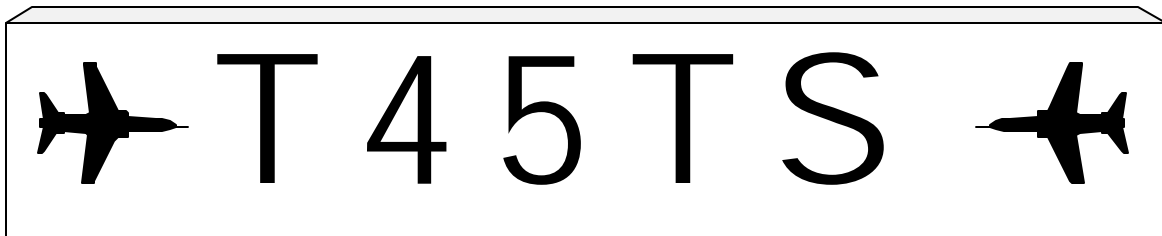
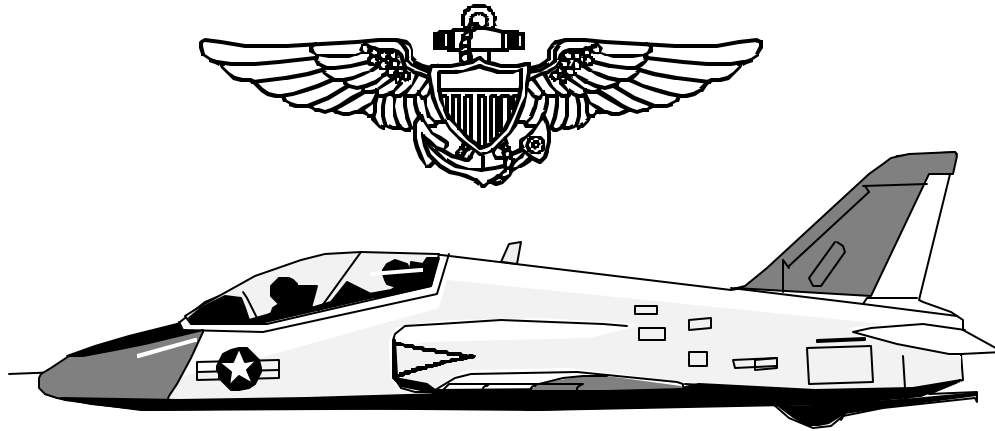

T-45A UJPT, ADV, & IUT ACMFP-06

AIR COMBAT MANEUVERING 2 V 1 FLIGHT PROCEDURES
Part 2

OVERVIEW

Part 1

1. Fighter Engagement Videos
2. Self-Test
3. Conduct of Hop
4. Engaged/Free Fighter Doctrine
5. Formations
6. Communication
7. Additional Considerations

Part 2

1. Engagements
2. Review

ENGAGEMENTS

Call the Bandit

Counterflow

No Switch

Single Switch

Multi-Switch Bugout

Multi-Switch Kill

Visual Forward Quarter (VFQ)

Beyond Visual Range (BVR)

ENGAGEMENTS

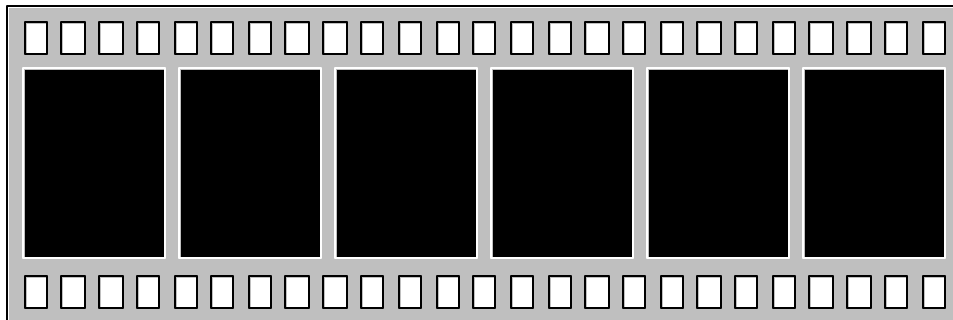

18-minute Video

ENGAGEMENTS

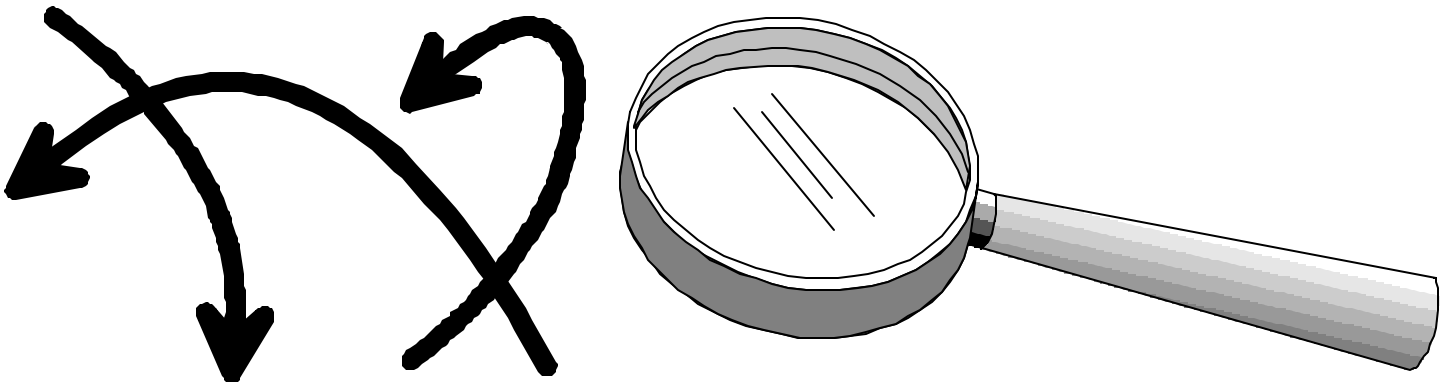

Now we will cover each of the individual engagements on the white board.

ENGAGEMENTS

Call the Bandit (No Switch):

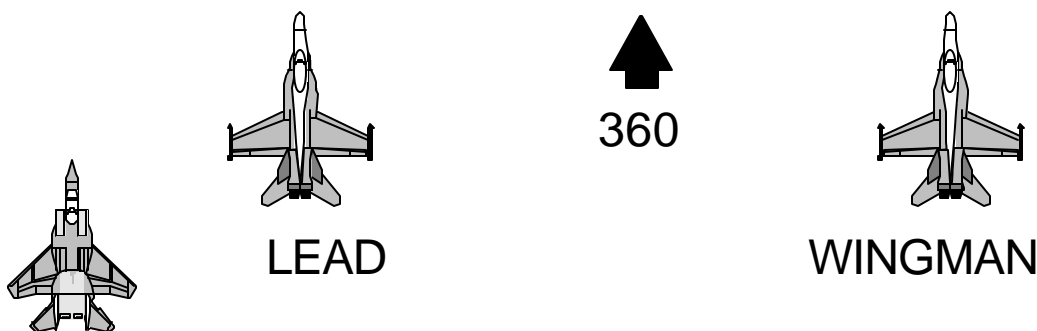

Need two volunteers to come up front and demo call the bandit no switch.

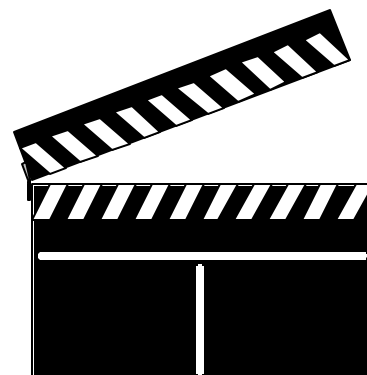

ENGAGEMENTS

Call the Bandit (Single Switch):



Need two new volunteers to come up front and demo call the bandit single switch.

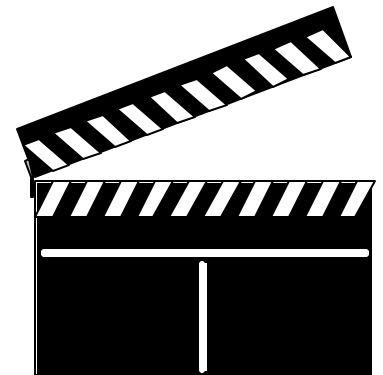

ENGAGEMENTS

Call the Bandit

Remember:

1. Know comm cold
2. Fly good platform as lead

ENGAGEMENTS

Counterflow

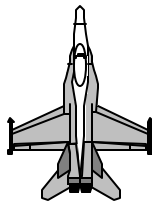

LEAD

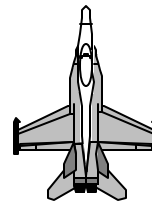

WINGMAN

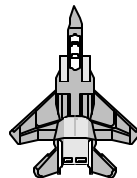

Draw and discuss on white board.

ENGAGEMENTS

Counterflow

Remember:

1. Talk and turn
2. Good break turn and defensive 1 v 1
3. Don't arc
4. Bandit planform +3 for horizontal/
+5 for vertical
5. Do not get into pitchbuck on turn in
6. "Tally visual" before Fox-2

ENGAGEMENTS

No Switch

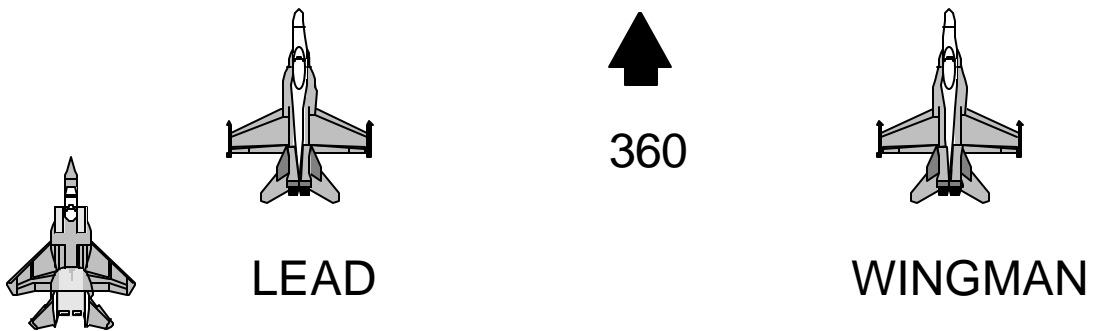

Draw and discuss on white board.

ENGAGEMENTS

No Switch

Remember:

1. Talk and turn
2. Good break turn
3. KIO (Knock it off) heading

ENGAGEMENTS

Single Switch



Draw and discuss on white board.

ENGAGEMENTS

Single Switch

Remember:

1. Talk and turn
2. Good break turn
3. Call the pass you see
4. Fight good scissors
5. “Tally visual” before you shoot

ENGAGEMENTS

Multi-Switch Bugout



Draw and discuss on white board.

ENGAGEMENTS

Multi-Switch Bugout

Remember:

1. Talk and turn
2. Good break turn
3. Call the pass you see
4. Fight good scissors
5. Free fighter call pass ASAP!
6. Kick fight across the tail and get nose down
7. Regain combat spread and mutual support

ENGAGEMENTS

Multi-Switch Kill

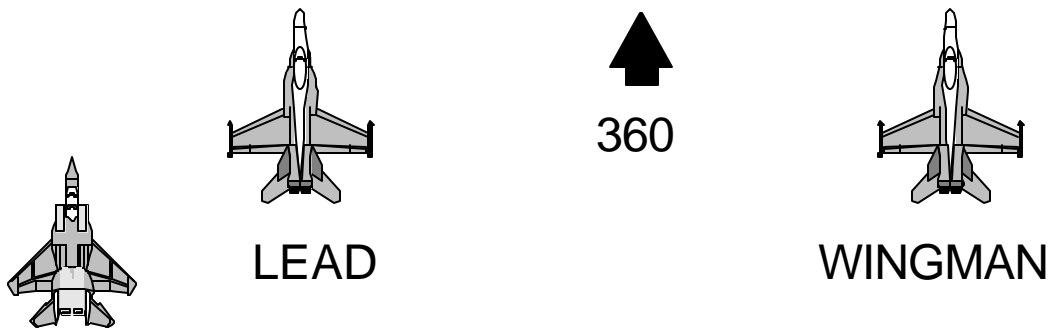

Draw and discuss on white board.

ENGAGEMENTS

Multi-Switch Kill

Remember:

1. Talk and turn
2. Good break turn
3. Call the pass you see
4. Fight good scissors
5. Free fighter call pass ASAP!
6. Kick fight across the tail and get nose down
7. Force the bandit 1 circle

ENGAGEMENTS

Visual Forward Quarter (VFQ)

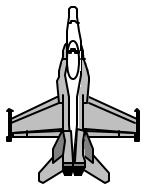

LEAD

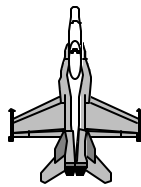

WINGMAN

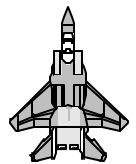

Draw and discuss on white board.

ENGAGEMENTS

Visual Forward Quarter (VFQ)

Remember:

1. Get comm out quickly
2. Turn 120 degrees at 6 o'clock before lead turn
3. Shoot at pass if you can
4. Call direction of engaged turns
5. Deconflict engaged fighter when taking Fox-2

ENGAGEMENTS

Beyond Visual Range (BVR)



BVR gives you a chance to use everything you have learned up to this point.

ENGAGEMENTS

Beyond Visual Range (BVR)

You will practice:

1. Formation management
2. Lookout doctrine
3. Engaging turns
4. Communications
5. Defining roles (free and engaged)
6. Forcing the bandit to be predictable
7. Staying out of phase and out of plane
8. Killing the bandit
9. Bugging out

ENGAGEMENTS

Beyond Visual Range (BVR):

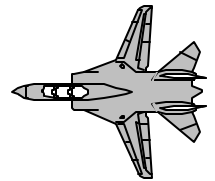
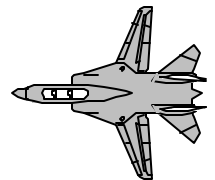
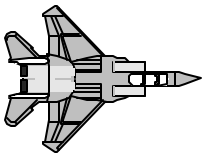

1. Select CAPS about 10-15 nm apart--either TACAN radials or ground gouge will work fine.

ENGAGEMENTS

Beyond Visual Range (BVR):

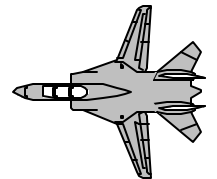
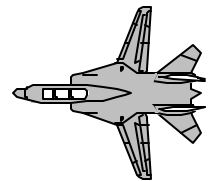
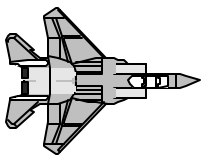

2. Choose your block. The low block is 10,000-15,000 ft and the high block is 16,000-20,000 ft--you may leave your block when either you or your wingman has sight of the bandit

ENGAGEMENTS

Beyond Visual Range (BVR):

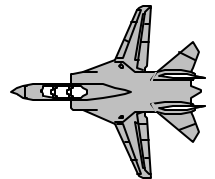
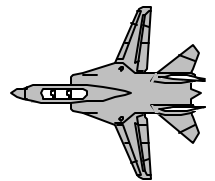
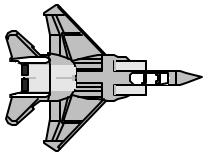

Now you have to get sight of that wily bandit ASAP!

ENGAGEMENTS

Beyond Visual Range (BVR)

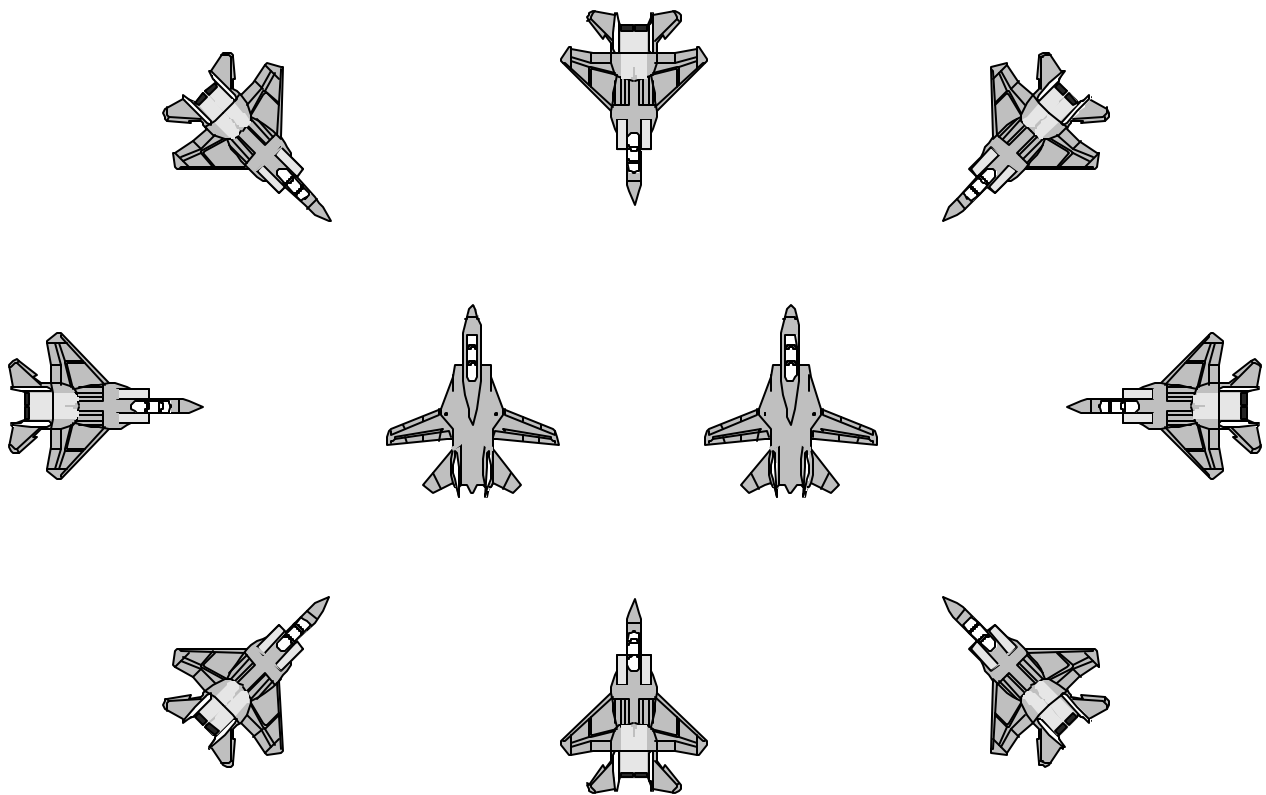

Let's see if we know what to do for all the above possibilities.

ENGAGEMENTS

Beyond Visual Range (BVR)

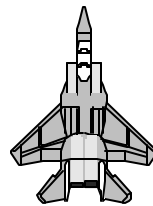
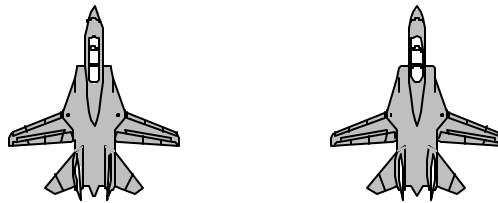

How could you handle this?

ENGAGEMENTS

Beyond Visual Range (BVR)

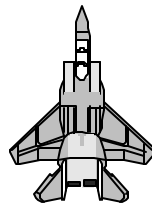
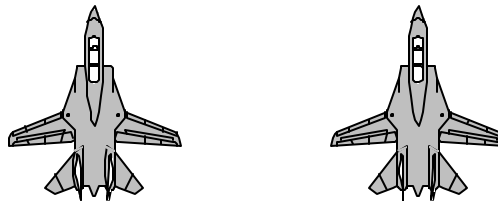

Counterflow

ENGAGEMENTS

Beyond Visual Range (BVR)

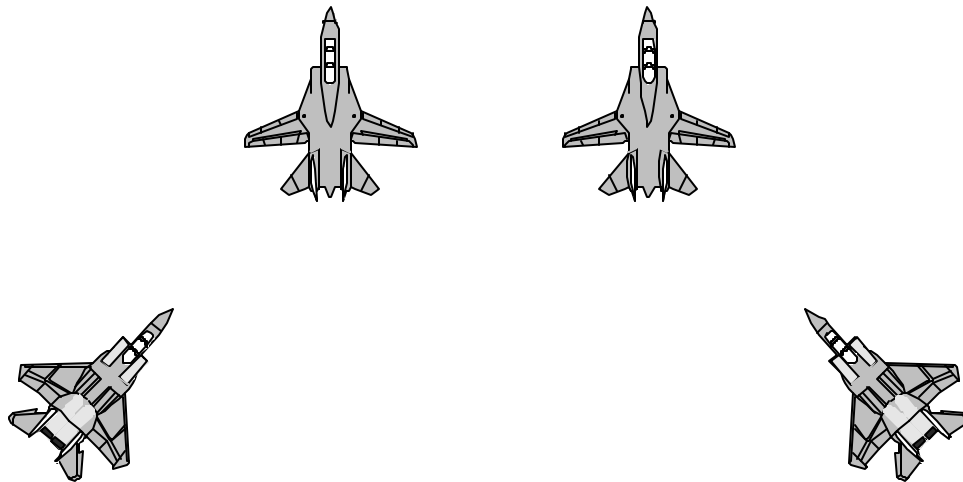

How could you handle this?

ENGAGEMENTS

Beyond Visual Range (BVR)

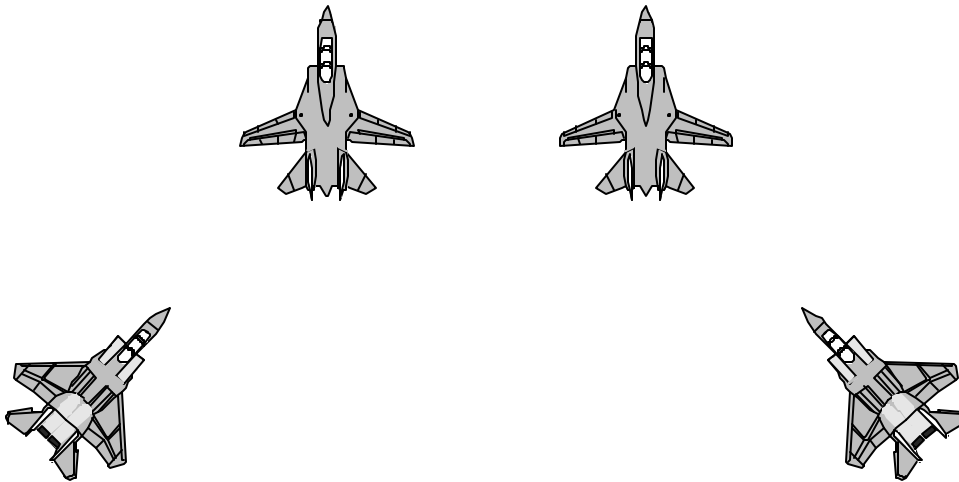

No-switch or multi-switch

ENGAGEMENTS

Beyond Visual Range (BVR)

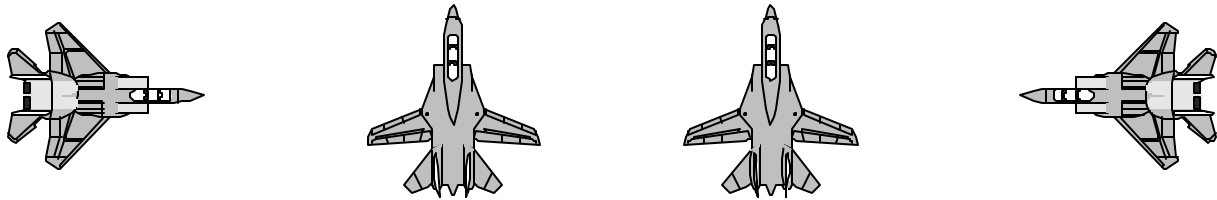

How could you handle this?

ENGAGEMENTS

Beyond Visual Range (BVR)

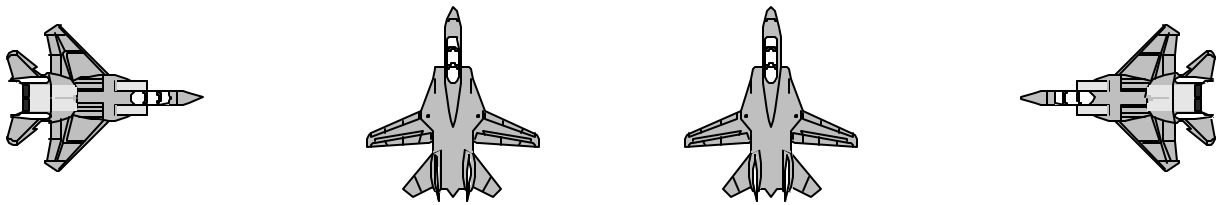

VFQ

ENGAGEMENTS

Beyond Visual Range (BVR)

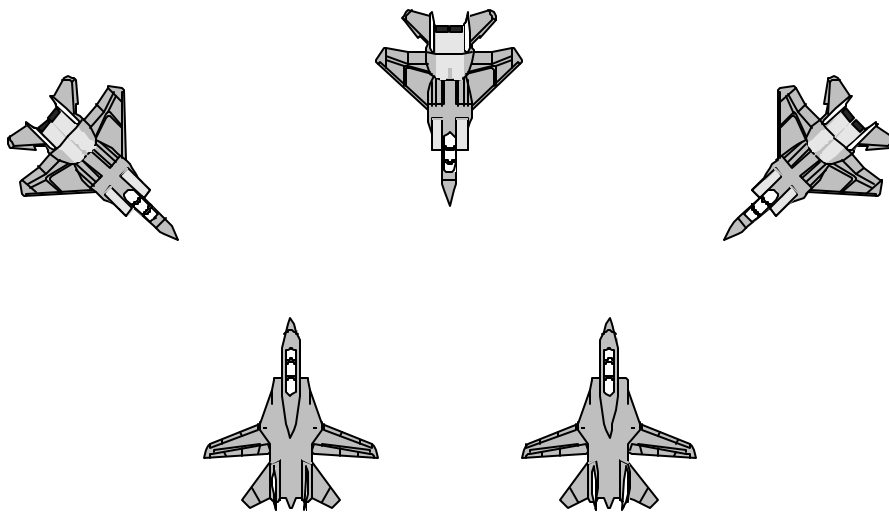

How could you handle this?

ENGAGEMENTS

Beyond Visual Range (BVR)

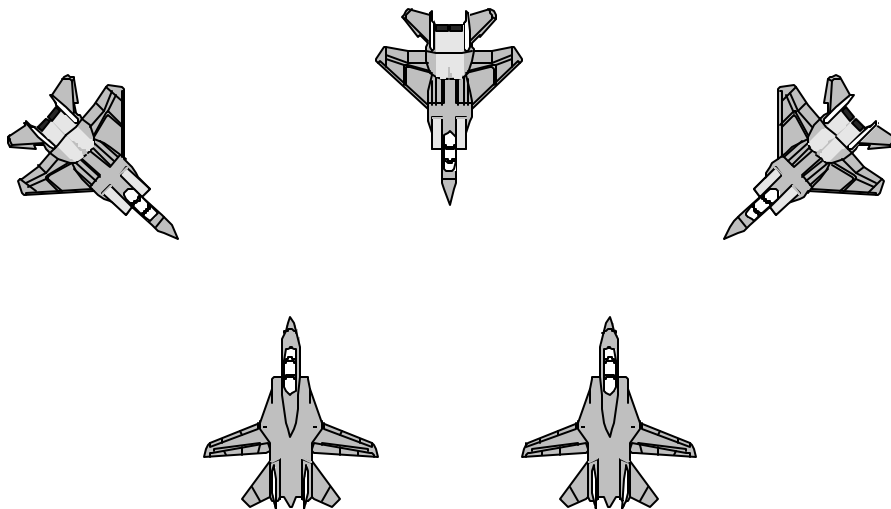

Execute a check turn or tac turn to set up
eyeball--shooter VFQ

ENGAGEMENTS

Beyond Visual Range (BVR)



BVR for Dick and Jane:

1. Define roles quickly
2. Engaged fighter must aggressively force bandit to be predictable
3. Free fighter work out of plane and phase for a quick kill
4. Keep sight
5. Repeat 1-4

REVIEW

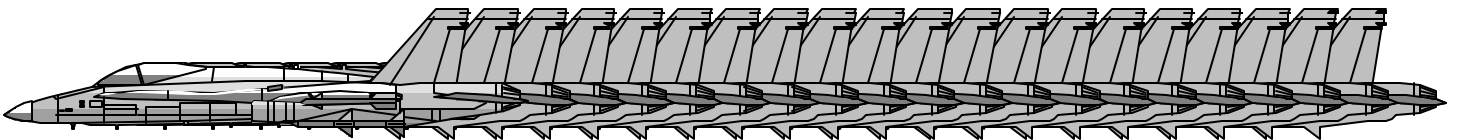
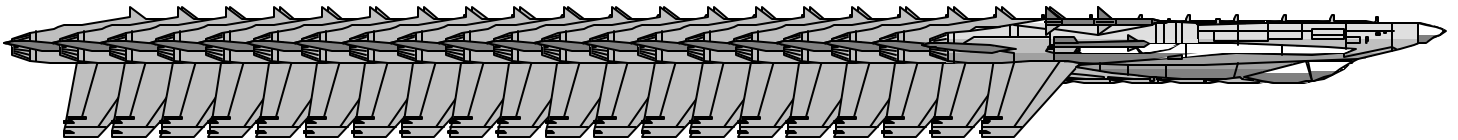

REVIEW

Three-Plane ACM

Review Options

1. Review the entire lesson
2. Conduct of Hop
3. Engaged/Free Fighter Doctrine
4. Formations
5. Communication
6. Additional Considerations
7. Engagements
8. End this lesson

Please select>

THE END

